

# 2024

## *Outboard Rigging and Parts*

Reliability Starts Here.®



# 1 General Information

# 2 Rigging Estimate Guide

Topic	Page
Yamaha Contacts	1-1
Part Returns	1-2
Quality Assurance Claims	1-2
Shipping Information	1-3
Warehouse Locations	1-3
Yamaha Outboard Model Codes	1-4
The Meaning of Yamaha's Part Number	1-5
Paint Codes	1-6
Outboard Genuine Parts Limited Warranty	1-7
PowerMatched® System Limited Warranty	1-8
Helm Master® EX PowerMatched®/Component Limited Warranty	1-9
Helm Master® EX PowerMatched®/Component Limited Warranty (cont.)	1-10
How to Navigate the Parts Tab in YMBS	1-11
The Parts Tab/Quick Links and Parts Messages	1-11
Order Instructions and Video Tutorials	1-11
Parts Inquiry/Checking Parts Availability	1-12
Order Management Screen - Placing a Parts Order	1-13
Editing a Draft Order	1-16
Order Line Management Screen	1-17
Detailed Search/Review Canceled Lines/ Open-Scheduled Orders/Backorders	1-18
Future Orders/Shipped Orders/Canceled Line 3-month history	1-19
Canceling an Order Line	1-20
Find a Part	1-20
Filing a Credit Order/Instructions and Video Tutorial	1-21
Returns Management/Search Criteria	1-22
Creating a New Return /Credit Request	1-23
Printing RMA (Return Material Authorization)	1-25
Checking Return Status	1-27
Quality Assurance Claims	1-28
MRP Parts Frequency Report	1-29
MRP Top Parts by YMA	1-30
MRP Programs	1-30
Knowledge Center	1-31
A Simple Guide to PartsManager Pro™	1-32
A Simple Guide to Helm Master® EX Rigging Builder	1-34
How to Contact your MRP Team	1-37

Topic	Page
Single Engine with Mechanical Side Mount Controls	2-1
Single Engine with Mechanical Flush Mount Controls	2-5
Single Engine with Mechanical Binnacle Controls	2-8
Helm Master® EX	2-17
Single Engine Single Station Level 2 EKS (KEY SWITCH) - Helm Master® EX	2-18
Single Engine Single Station Level 2 6X6 (KEY SWITCH) - Helm Master® EX	2-19
Single Engine Maneuverability Kit for Built in Electric Steering - Helm Master® EX	2-20
Single Engine Second Station Level 4 - Helm Master® EX	2-21
Twin Engines with Mechanical Binnacle Controls	2-22
Twin Engine Single Station Level 2 EKS (KEY SWITCH) - Helm Master® EX	2-25
Twin Engine Single Station Level 2 6X6 (KEY SWITCH) - Helm Master® EX	2-26
Twin Engine Maneuverability Kit for Built in Electric Steering - Helm Master® EX	2-27
Twin Engine Second Station Level 4 - Helm Master® EX	2-28
Triple Engine Single Station Level 2 EKS (KEY SWITCH) - Helm Master® EX	2-29
Triple Engine Single Station Level 2 6X6 (KEY SWITCH) - Helm Master® EX	2-30
Triple Engine Maneuverability Kit for Built in Electric Steering - Helm Master® EX	2-31
Triple Engine Second Station Level 4 - Helm Master® EX	2-32
Quad Engine Single Station Level 2 EKS (KEY SWITCH) - Helm Master® EX	2-33
Quad Engine Single Station Level 2 6X6 (KEY SWITCH) - Helm Master® EX	2-34
Quad Engine Single Station Level 4 w/MDF Type 2 - Helm Master® EX	2-35
Quad Engine Second Station Level 4 - Helm Master® EX	2-36
Adding a Multi-Hub	2-37
Adding an AGI (Analog Gauge Interface)	2-39
Adding a Multisensor	2-40
Y-COP® with Single Engine	2-41
Y-COP® with Twin/Triple Engines with Command Link® Main Switches	2-42
Y-COP® with Twin/Triple Engines with Command Link Plus® Main Switches	2-43
Adding in a Bow Thruster	2-44

# 3 Rigging Components

Topic	Page
Gauges	3-1
Digital Electronic Control (DEC) Gauge Kits	3-9
Command Link® Gauge Kits	3-12
Single Engine Gauge Kits	3-12
Twin Engine Gauge Kits	3-15
Multifunction Gauge Kits	3-16
Helm Master® EX Main Station Kits	3-17
Helm Master® EX Second Station Kits	3-21
Helm Master® EX Steering Kits	3-25
Helm Master® EX Digital Electronic Control Boxes	3-26
Mechanical Control Boxes	3-27
Tiller Handles	3-29
Control Cables	3-30
Control Cable Ends	3-31
Helm Master® EX Main Switches	3-32
Command Link Plus® Main Switches	3-34
Command Link® and Conventional Main Station Switch Panels	3-36
Command Link® and Conventional Second Station Switch Panels	3-38
Replacement Keys and Key Covers	3-39

# 4 Electrical Components

Topic	Page
Helm Master® Harnesses	4-1
Command Link® and Command Link® Plus Harnesses	4-8
Command Link® and Command Link Plus® Accessories	4-13
Conventional Harnesses	4-17
Conventional Accessories	4-22
Charging, Starting, and Battery Cables	4-23
Switches and Indicators	4-25
Wire Connections and Circuit Protection	4-26

# 5 Engine Accessories

Topic	Page
Fuel System Components	5-1
2-Stroke Oil Systems	5-4
Rigging Tubes and Grommets	5-5
Steering System	5-6
Remote Control Attachment Kits	5-9
Cowling Covers	5-12
Engine Security	5-14
General Engine Accessories	5-15
Siren Marine®	5-18
Bennett Marine Common Replacement Parts & Accessories	5-19

# 6 Propellers

Topic	Page
Propeller Quick Reference Chart	6-1
Yamaha Propeller Descriptions	6-3
XTO Propeller Descriptions	6-6
Turbo Propeller Descriptions	6-7
How to Pick a Propeller	6-10
Propeller Terminology	6-11
Propellers for Two Stroke 2-15, and Four Stroke F2.5-F20	6-14
F Series Propellers for 3.0" Gearcases	6-15
G Series Propellers for 3.5" Gearcases	6-15
K Series Propellers for 4.25" Gearcases	6-16
P Series Propellers for 4.25" and 4.75" Gearcases	6-18
M Series Propellers for 4.75" Gearcases	6-18
T Series Propellers for 4.75" Gearcases	6-19
X Series Propellers for 5.25" Gearcases	6-21
Y Series Propellers for 6.0" Gearcases	6-22
Small Hub Propellers for High Performance Applications	6-23
TRP (Twin Rotating Propellers) for TRP Gearcases	6-23
Sharrow MX3 V6 Propellers	6-24
Turbo Propellers for 3.0" (F Series) Gearcases	6-25
Turbo Propellers for 3.5" (G Series) Gearcases	6-25
Turbo Propellers for 4.25" (K Series) Gearcases	6-26
Turbo Propellers for 4.75" (M/T Series) Gearcases	6-27
Hubs for Yamaha Propellers	6-32
Hubs for Turbo Propellers	6-33
Turbo Hub Application Charts	6-34
Propeller Hardware Kits	6-43
Propeller Accessories	6-44

# 7 Maintenance Items

Topic	Page
Maintenance Capacities Chart	7-1
4-Stroke Spark Plugs	7-3
2-Stroke Spark Plugs	7-5
4-Stroke Oil Filters	7-6
2-Stroke Oil Strainers	7-7
In Line Fuel Filters	7-8
Primary Fuel Filters	7-9
Remote Mounted Fuel Filters	7-11
Vapor Separator Tank (VST) Fuel Filters	7-12
VST Gaskets	7-13
Engine Timing Belts	7-14
Trim Tabs	7-15
Anodes/Anode Kits	7-16
Thermostats	7-17
Thermostat Gaskets	7-18
4-Stroke Carburetor Repair Kits	7-19
2-Stroke Carburetor Repair Kits	7-23
Water Pump Housings	7-29
4-Stroke Water Pump Repair Kits	7-30
2-Stroke Water Pump Repair Kits	7-34
All-New 100-Hour Service Kit	7-40

# 9 Accessories and Apparel

Topic	Page
Anchors	9-1
Fenders	9-3
Ropes and Dock Lines	9-6
Tubes and Inflatables	9-9
Inflatable Pumps and Valves	9-11
Battery Chargers and Battery Switches	9-12
Magma® Grills and Accessories	9-13
Coolers	9-19
Boat Starter Kits	9-20
General Boating Accessories and Upgrades	9-21
Personal Floatation Devices	9-25
Hats and Visors	9-27
Apparel and Gifts	9-28

# 8 Yamalube and Trailer Supplies

Topic	Page
Oil and Lubes POP (Point of Purchase) Material	8-1
Outboard Engine Oil	8-2
Outboard Oil Change Kits	8-3
Pumps and Spouts	8-4
Fuel Additives	8-6
Grease	8-7
Yamabond® Adhesives	8-9
Shop Supplies	8-10
For the Technician	8-12
Cleaning Chemicals	8-13
Tire Repair and Supplies	8-14
Locks and Security	8-14
Trailer Repair Supplies	8-15
Tie Downs and Straps	8-16
YDIS (Yamaha Diagnostic System)	8-17

# Index

A	
Topic	Page
Accessories, General Engine	5-15
Adhesives	8-9
AGI (Analog Gauge Interface), Adding an	2-39
Anchors	9-1
Anodes/Anode Kits	7-16
Apparel & Gifts	9-28

B	
Topic	Page
Battery Cables	4-23
Battery Chargers	9-12
Battery Management System	4-7
Battery Switches	9-12
Battery Switches: Bennett Replacement Parts	5-19
Boat Starter Kits	9-20
Bow Thruster, Adding in	2-44

C	
Topic	Page
Carburetor Kits 2-Stroke	7-23
Carburetor Kits 4-Stroke	7-19
Circuit Protection	4-26
Cleaning Chemicals	8-13
Command Link® Accessories	4-13
Command Link® Gauges	3-1
Command Link® Main Switches	3-36
Command Link Plus® Gauge	3-1
Command Link® Gauges Kits	3-12
Command Link Plus® Main Switches	3-34
Control Boxes, DEC	3-26
Control Boxes, Mechanical	3-27
Control Cable Ends	3-31
Control Cables	3-30
Coolers	9-19
Conventional Harnesses	4-17
Cowling Covers	5-12
Cowling, F9.9/T9.9 Covers Graphics	5-13

D	
Topic	Page
DEC Control Boxes	3-26
DEC Gauge Kits	3-9
Dock Lines	9-6

E	
Topic	Page
Engine Covers	5-12
Engine Oil	8-2
Engine Security	5-14

F	
Topic	Page
Fenders	9-3
Flushing System, Automatic	5-17
Fuel Additives	8-6
Fuel Filters, In Line	7-8
Fuel Filters, Primary	7-9
Fuel Filters, Remote Mounted	7-11
Fuel Filters, Vapor Separator Tank (VST)	7-12
Fuel System Components	5-1

G	
Topic	Page
Gaskets, Thermostat	7-18
Gaskets, VST	7-13
Gateway, Adding the	2-39
Gauges, Individual	3-1
Grease	8-7
Grills and Accessories	9-13

H	
Topic	Page
Harnesses, Command Link® and Command Link Plus®	4-8
Harnesses, Conventional	4-17
Hats and Visors	9-27
Helm Master® EX Main Station Kits	3-17
Helm Master® EX Second Station Kits	3-21
Helm Master® EX Steering Kits	3-25
Helm Master® EX Main Switches	3-32
Helm Master® Harnesses	4-1
Hub Application Charts, Turbo	6-34
Helm Master® Harnesses	4-1
Hubs for Turbo Propellers	6-33
Hubs for Yamaha Propellers	6-32

Topic	Page
Inflatables	9-9
Inflatable Pumps and Valves	9-11
Indicators	4-25

Topic	Page
Locks and Engine Security	5-14
Locks and Security	8-14

Topic	Page
Main Switches, Command Link® and Conventional	3-36
Main Switches, Command Link® and Conventional Second Station Switch Panels	3-38
Main Switches, Command Link Plus®	3-34
Maintenance Capacities Chart	7-1
Mechanical Control Boxes	3-27
Mechanical Control - Control Cable Ends	3-31
Mechanical Control - Control Cables	3-30
Mechanical Control Gauges	3-1
Mechanical Control Harnesses	4-9
Mechanical Control Main Switches	3-34
Mechanical Control Single Engine Gauge Kits	3-11
Mechanical Control Single Engine Rigging Diagrams	2-1
Mechanical Control Tiller Handles	3-29
Mechanical Control Twin Engine Gauge Kits	3-15
Model Codes, Yamaha Outboard	1-4
Multifunction Gauge Kits	3-16
Multi-Hub, Adding a	2-37
Multisensor, Adding a	2-40

Topic	Page
Oil and Lubes POP (Point of Purchase) Material	8-1
Oil, Outboard Change Kits	8-3
Oil Filters, 4-Stroke	7-6
Oil Strainers, 2-Stroke	7-7
Oil Systems, 2-Stroke	5-4
Oil, Outboard Engine	8-2

Topic	Page
Paint	8-11
Paint Codes	1-6
Part Number, The Meaning of Yamaha's	1-5
Parts Inquiry/Availability	1-12
Parts Order Menu	1-13
PartsManager Pro™, A Simple Guide to	1-32
Personal Flotation Devices	9-25
Propeller Accessories	6-44
Propeller Descriptions, Yamaha	6-3
Propeller Descriptions, Turbo	6-7
Propeller Hardware Kits	6-43
Propeller Quick Reference Chart	6-1
Propeller Terminology	6-11
Propeller, How to Pick a	6-10
Propellers for 2-Stroke 2-15, and 4-Stroke F2.5-F20	6-14
Propellers for 3.0" Gearcases, F Series	6-15
Propellers for 3.5" Gearcases, G Series	6-15
Propellers for 4.25" Gearcases, K Series	6-16
Propellers for 4.25" and 4.75" Gearcases, P Series	6-18
Propellers for 4.75" Gearcases, M/T Series	6-18
Propellers for 5.25" Gearcases, X Series	6-21
Propellers for 6.0" Gearcases, Y Series	6-22
Propellers, Small Hub, for High Performance Applications	6-23
Propellers for (Twin Rotating Propellers)	6-23
TRP Gearcases	
Propellers, Sharrow MX3 V6	6-24
Pumps and Spouts, Oil	8-4

Topic	Page
Quad Engine Single Station Level 2 EKS (KEY SWITCH) - Helm Master® EX	2-33
Quad Engine Single Station Level 2 6X6 (KEY SWITCH) - Helm Master® EX	2-34
Quad Engine Single Station Level 4 w/MDF Type 2 - Helm Master® EX	2-35
Quad Engine Second Station Level 4 - Helm Master® EX	2-36
Quality Assurance Claims	1-2

Topic	Page
Remote Control Attachment Kits	5-9
Remote Controls, DEC	3-26
Remote Controls, Mechanical	3-27
Replacement Keys and Key Covers	3-39
Rigging Tubes and Grommets	5-5
Ropes	9-6

# S

Topic	Page
Shipping Information	1-3
Service Kit, 100-Hour	7-40
Shop Supplies	8-10
Single Engine Gauge Kits (Multi-Function)	3-16
Single Engine with DEC Flush Mount Controls	2-17
Single Engine with Mechanical Binnacle Controls	2-8
Single Engine with Mechanical Flush Mount Controls	2-5
Single Engine with Mechanical Side Mount Controls	2-1
Single Engine Single Station Level 2 EKS (KEY SWITCH) - Helm Master® EX	2-18
Single Engine Single Station Level 2 6X6 (KEY SWITCH) - Helm Master® EX	2-19
Single Engine Second Station Level 4 - Helm Master® EX	2-21
Siren Marine	5-18
Spark Plugs, 2-Stroke	7-5
Spark Plugs, 4-Stroke	7-3
Starting	4-23
Steering System	5-6
Straps	8-16
Switches	4-25
Switches, Command Link® Main (Key)	3-36
Switches, Command Link Plus® Main (Key)	3-34
Switches, Mechanical Main (Key)	3-36

Topic	Page
Thermostat Gaskets	7-18
Thermostats	7-17
Tie Downs	8-16
Tiller Handles	3-29
Tiller Handle Fitting Kits	3-29
Tilt Limiters	5-16
Timing Belts	7-14
Tools for the Technician	8-12
Trailer Repair Supplies	8-15
Trim Tabs	7-15
Triple Engine Single Station Level 2 EKS (KEY SWITCH) - Helm Master® EX	2-29
Triple Engine Single Station Level 2 6X6 (KEY SWITCH) - Helm Master® EX	2-30

Topic	Page
Triple Engine Single Station Level 4 w/ MFD Type 2 - Helm Master® EX	2-31
Triple Engine Second Station Level 4 - Helm Master® EX	2-32
Tubes	9-9
Turbo Propellers for 3.0" Gearcases, F Series	6-25
Turbo Propellers for 3.5" Gearcases, G Series	6-25
Turbo Propellers for 4.25" Gearcases, K Series	6-26
Turbo Propellers for 4.75" Gearcases, M /T Series	6-27
Twin Engine Gauge Kits	3-15
Twin Engines with Mechanical Binnacle Controls	2-22
Twin Engine Single Station Level 2 EKS (KEY SWITCH) - Helm Master® EX	2-25
Twin Engine Single Station Level 2 6X6 (KEY SWITCH) - Helm Master® EX	2-26
Twin Engine Maneuverability Kit for Built in Electric Steering - Helm Master® EX	2-27
Twin Engine Second Station Level 4 - Helm Master® EX	2-28

Topic	Page
VST Gaskets	7-13

Topic	Page
Warehouse Locations	1-3
Warranty, Outboard Genuine Parts	1-7
Warranty, PowerMatched® System	1-8
Warranty, Helm Master® EX	1-9
PowerMatched® /Component	1-9
Water Pump Housings	7-29
Water Pump Repair Kits 2-Stroke	7-34
Water Pump Repair Kits 4-Stroke	7-30
Wire Connections	4-26

Topic	Page
Y-COP® with Single Engine	2-41
Y-COP® with Twin or Triple Installations with Command Link® Main Switches	2-42
Y-COP® with Twin or Triple Engines with Command Link Plus® Main Switches	2-43
YDIS (Yamaha Diagnostic System)	8-17
YMBS - Knowledge Center	1-31
YMBS - Order Management-Placing a Parts Order	1-13
YMBS - Order Management-Editing a Draft Orders	1-16
YMBS - Returns Management	1-22
YMBS - How to Navigate the Parts Tab	1-11







<b>Description</b>	<b>Page</b>
Yamaha Contacts	1-1
Part Returns	1-2
Quality Assurance Claims	1-2
Shipping Information	1-3
Warehouse Locations	1-3
Yamaha Outboard Model Codes	1-4
The Meaning of Yamaha's Part Number	1-5
Paint Codes	1-6
Outboard Genuine Parts Limited Warranty	1-7
PowerMatched® System Limited Warranty	1-8
Helm Master® EX PowerMatched®/Component Limited Warranty	1-9
Helm Master® EX PowerMatched®/Component Limited Warranty (cont.)	1-10
How to Navigate the Parts Tab in YMBS	1-11
The Parts Tab / Quick Links and Parts Messages	1-11
Order Instructions and Video Tutorials	1-11
Parts Order Menu	
<i>Parts Inquiry/Checking Parts Availability</i>	1-12
<i>Order Management Screen - Placing a Parts Order</i>	1-13
<i>Editing a Draft Order</i>	1-16
<i>Order Line Management Screen</i>	1-17
<i>Detailed Search/Review Canceled Lines/Open-Scheduled Orders/Backorders</i>	1-18
<i>Future Orders/Shipped Orders/Canceled Line 3-month history</i>	1-19
<i>Canceling an Order Line</i>	1-20
<i>Find a Part</i>	1-20
<i>Filing a Credit Order</i>	1-21
<i>Instructions and Video Tutorial</i>	1-21
<i>Returns Management</i>	1-22
<i>Search Criteria</i>	1-22
<i>Creating a New Return</i>	1-23
<i>Printing RMA (Return Material Authorization)</i>	1-25
<i>Checking Return Status</i>	1-27
<i>Quality Assurance Claims</i>	1-28
<i>MRP Parts Frequency Report</i>	1-29
<i>MRP Top Parts by YMA</i>	1-30
<i>MRP Programs</i>	1-30
<i>Knowledge Center</i>	1-31
<i>A Simple Guide to PartsManager Pro™</i>	1-32
<i>A Simple Guide to Helm Master® EX Rigging Builder</i>	1-34
<i>How to contact your MRP Team</i>	1-37

## Marine Rigging and Parts General Information

This section is intended to give you an overview of the systems used to find, order, and answer questions about Yamaha Marine Rigging and Parts (MRP). There is a lot of information given to Yamaha Authorized Dealers, and it is important that you are familiar with that information to better serve your customers. Because we are constantly working to improve your experience when doing business with us, information such as part numbers or locations referenced in Yamaha Marine Business System (YMBS) may change. Please remember to always check YMBS for the most up to date information.

### Yamaha Contacts

Marine Sales and Service	Phone Number	Fax Number	Normal Hours of Operation (ET)
Outboard Unit Sales	(800) 628-9006	(800) 972-3013	Mon ~ Fri - 8:30 am - 5:30 pm
Marine Rigging and Parts Oil and Lubes	(800) 366-1972	(770) 420-5761	Mon ~ Fri - 8:30 am - 5:30 pm Closed for Lunch 12:00 pm - 1:00 pm
Marine Service Dealer Support	(800) 353-5900	(770) 420-6105	Mon ~ Fri - 8:30 am - 5:30 pm Closed for Lunch 12:00 pm - 1:00 pm
Marine Service Customer Support	(866) 894-1626 Opt. 3 - Bennett Marine Opt. 4 - Siren Marine	(770) 420-6106	Mon ~ Fri - 8:30 am - 5:30 pm Closed for Lunch 12:00 pm - 1:00 pm
Marine Technical Training (YMU, Training Classes)	(800) 854-4876 Opt. 1 - YDIS Help Opt. 3 - YMU	(770) 420-6181	Mon ~ Fri - 8:30 am - 5:30 pm
Generator Sales	(800) 845-3650		Mon ~ Fri - 8:30 am - 5:00 pm

Warranty and Y.E.S	Phone Number	Fax Number	Normal Hours of Operation (ET)
Warranty Authorizations	(800) 353-5900	(770) 420-6105	Mon ~ Thurs - 8:30 am - 5:30 pm Fri - 8:30 am - 3:00 pm
Warranty Administration (General Information)	(800) 227-5963		Mon ~ Fri - 8:30 am - 5:30 pm
General Information about Y.E.S.	(800) 559-0325		Mon ~ Fri - 8:30 am - 5:00 pm
Warranty Logistics	(800) 537-3835 - Opt. 3		Mon ~ Fri - 8:30 am - 5:00 pm

Shipping Traces and Invoice Copies	Phone Number	Fax Number	Normal Hours of Operation (ET)
Kennesaw, GA - Warehouse #34	(800) 366-1972	Also Available in YMBS	Mon ~ Fri - 8:30 am - 5:30 pm Closed for Lunch 12:00 pm - 1:00 pm
Lakeview, WI - Warehouse #33	(262) 947-6102	Also Available in YMBS	Mon ~ Fri - 9:30 am - 6:00 pm
Cypress, CA - Warehouse #31	(714) 761-7764	Also Available in YMBS	Mon ~ Fri - 11:30 am - 8:00 pm

Outboard Unit Shipping Damage	Phone Number	Fax Number	Normal Hours of Operation (ET)
Internal or Concealed Crate Damage	(800) 227-5963		Mon ~ Fri - 8:30 am - 5:00 pm
External or Visible Crate Damage	(800) 537-3835		Mon ~ Fri - 8:30 am - 5:00 pm

Financial Services	Phone Number	Fax Number	Normal Hours of Operation (ET)
YMFUS Open Account/ Package Dealers	(877) 900-0850 Opt 1 – Sharon Willis Opt 2 – Dirk Venables Opt 3 – Gunter Laprad	(770) 420-5929	Mon ~ Fri - 8:30 am - 5:00 pm
YMFUS Wholesale Full line Account Manager	(800) 355-5218 Option #5		Mon ~ Fri - 8:30 am - 5:00 pm

YMBS/PartsManager Pro™/ Other Companies	Phone Number	Fax Number	Normal Hours of Operation (ET)
YMBS Support	(800) 854-4876		Mon ~ Fri - 8:30 am - 5:00 pm Closed for Lunch 3:00 pm to 4:00 pm
PartsManager Pro™	(800) 709-7773		Mon ~ Thurs - 24 hours; Fri - 7 am - 9 pm Sat - 7 am - 4:00 pm; Sun - 7:00 am - 6 pm
K&L Tool Supply (Special Tools)	(800) 708-3184	(408) 727-6767	Mon ~ Fri - 11:00 am - 8:00 pm
ColorRite® Paint (Touch Up Paint)	(800) 736-7980		Mon ~ Fri - 9:00 am - 8:00 pm
Crestec® LA (Owners and Service Manuals)	(888) 530-9446	(310) 532-061	Mon ~ Fri - 11:00 am - 7:30 pm

## Part Returns

**Credit Order (Parts Return)** - Returns are filed on YMBS when you need a credit or to return a part and accessory within 90 days of receipt. This includes credit and returns due to shipping or ordering error, damaged or missing parts, etc.

**Restocking Fees** - Parts returned within 60 days of the invoice date receive a 10% restock fee.\* Parts returned within 61-90 days of the invoice date receive a 15% restocking fee.\* Returns for parts over 90 days from the invoice date are not allowed.

**Returned Part Condition** - Parts must be returned in new and re-sellable condition or they will be returned to the dealer at the dealer's expense.

**Large Part Returns** - Yamaha recommends large parts, such as lower units, to be shipped with a local freight line to help reduce shipping damage. **If a large part is received with shipping damage, the shipment will be refused and Yamaha is not responsible for freight damage.**

**Shipping Damage** - Items received damaged must be noted on the bill of lading or delivery receipt. Damage /shortage claims must be filed within 15 days of receipt. Dealer must keep packaging and damaged item(s) for 90 days.

**Yamalube** - Returns not accepted; Contact Marine Rigging and Parts at 800-366-1972 and refer to Marine Rigging and Parts Info Exchange RP2023-001.

**Marine Obsolescence** - (OBS) is offered once a year - it will be posted on YMBS.

## Quality Assurance Claims

**Quality Assurance Claims** - A parts warranty claim can be filed for manufacturing defects for up to one (1) year from the date of retail purchase for pleasure use and 90 days for commercial use. Please refer to the part and accessory warranty statement for more information.

**Defective Parts** - All parts must be held for 90 days. If Yamaha requests the failed part back, a call tag will be issued through YMBS.

**Coverage Questions** - If you have any questions about the coverage of a specific failure or need authorization for a repair over \$1500.00, call the Marine Service Call Center at (800) 353-5900.

*Additional Information about coverage and filing procedures can be found in the Warranty and Y.E.S. Handbook. The Warranty and Y.E.S. Handbook can be found under the service tab in YMBS.*

*\* Subject to applicable Program Terms and Conditions.*

## Shipping Information

**Same Day Shipping** - Orders must be received and assigned a Yamaha sales order number by the cutoff time in order to ship the same day. (Cutoff time is 1:00 pm at the actual shipping warehouse).

**Emergency Orders** - The MRP Sales Team will try to assist you in an emergency situation with no additional fees; however, this depends on the warehouse volume for that day and is not a guarantee for orders placed past the cutoff time. Remember to check for availability and warehouse location prior to calling, (800) 366-1972 to avoid multiple shipment fees. Emergency orders can only be placed by calling the parts team.

**Shipping Options** - Yamaha offers Next Day Air, 2nd Day Air, 3-Day Select & Saturday delivery if available in your area. Shipping fees will apply to each package shipped including back orders.

**Hard Parts Freight Policy** - On Standard program orders totaling \$250 dollars or more (excluding oils, lubes, and chemicals) will ship pre-paid ground freight with Yamaha's choice of carrier. If a freight carrier and/or expedited shipping method is selected by the dealer, the dealer will pay the freight cost regardless of order value.

**Oil, Lube and Chemical Freight Policy** - Oil, Lube, and chemicals must be placed on the appropriate sales program and meet the minimum requirements of the sales program to receive free freight. Contact MRP sales team for program information at 800-366-1972.

**Back ordered Part Freight** - Remember to check for back orders after the Yamaha Sales order number is assigned. All back orders will ship the same method as the original order was placed when available. If a freight carrier and/or expedited shipping method was selected by the dealer, the dealer will pay the freight cost regardless of order value.

**Alternative Warehouse** - Your dealership is assigned a facing warehouse. The system will ship all available items from your facing warehouse, then check alternate warehouses for stock to fill your order.

**Drop Shipping** - Yamaha does not offer drop shipping to another location or address. All shipments will be sent to the address assigned to your Yamaha Dealer number. Notify your Yamaha District Marketing Manager immediately if you change your address or location.

**Shipping Cost and Time Quotes** - You can now use the shipping options feature in YMBS while placing your order. You can change your shipping method, receive an estimated freight cost and estimated transit times.

**Shipping Damage** - If a part is received with visible shipping damage, document the damage at the time of delivery. Take pictures of the damage and save the original box. For oil and lube shipping damage refer to Info. Exchange RP2023-001 found in the Knowledge Center of YMBS.

## Warehouse Locations

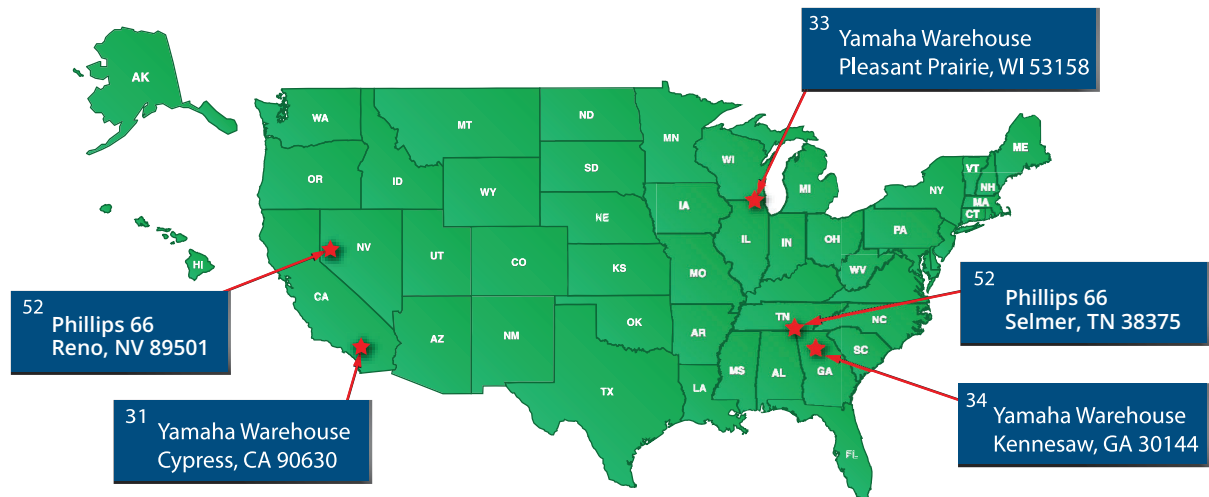

Warehouse:	#34 Kennesaw, GA	#33 Pleasant Prairie, WI	#31 Cypress, CA
Address:	1270 Chastain Road Kennesaw, GA 30144	10801 88th Ave. Pleasant Prairie, WI 53158	6555 Katella Ave. Cypress, CA 90630
Time Zone:	Eastern	Central	Pacific
Cut Off Time:	1:00 pm ET	1:00 pm CT	1:00 pm PT

## Yamaha Outboard Model Codes

### Early Models

<b>V</b> Model Description	<b>B</b> = Inshore Series <b>C</b> = C Series <b>D</b> = Twin Propellers <b>E</b> = Enduro Series <b>F</b> = Four-Stroke <b>L</b> = Counter Rotation <b>P</b> = Pro Series <b>S</b> = Saltwater Series <b>T</b> = High Thrust <b>V</b> = V MAX® Series <b>X</b> = Extreme Thrust Offshore <b>Z</b> = HPDI® <small>(High Pressure Direct Injection)</small>
<b>X</b> Fuel Induction	<b>F</b> = Four Stroke <b>X</b> = <b>OX66 Advanced Fuel Injection</b> <b>Z</b> = HPDI® (High Pressure Direct Injection)
<b>150</b> Prop Shaft Horsepower	Example: 6   9.9   90   150   250   300
<b>B</b> New Model Designator	<p>Any letter appearing between Prop Shaft Horsepower and Starting/Tilt Method is a "New Model Designator". Where used, these distinguish enhancement(s) to an existing outboard model sufficient to deem it a new model, or a completely new outboard that is a direct replacement of an existing outboard model.</p> <p><b>Example:</b>            VZ300BTLR            F9.9FMSH            F15CPLH            F40BTLR</p>
<b>T</b> Starting/Tilt Method	<b>Blank</b> = PTT & Electric Start <b>T</b> = Power Trim and Tilt <b>P</b> = Power Tilt with Electric Start <b>E</b> = Manual Tilt with Electric Start <b>M</b> = Manual Tilt with Manual Start
<b>L</b> Shaft Length	<b>S</b> = 15" <b>U</b> = 30" <b>L</b> = 20" <b>J</b> = Jet Drive Unit <b>X</b> = 25"
<b>R</b> Control Method	<b>R</b> = Remote Control <b>H</b> = Tiller Handle
<b>D</b> Model Year	<b>n/a*</b> = 2006 <b>Y</b> = 2000 <b>S</b> = 1994 <b>D</b> = 2005 <b>X</b> = 1999 <b>R</b> = 1993 <b>C</b> = 2004 <b>W</b> = 1998 <b>Q</b> = 1992 <b>B</b> = 2003 <b>V</b> = 1997 <b>P</b> = 1991 <b>A</b> = 2002 <b>U</b> = 1996 <b>Z</b> = 2001 <b>T</b> = 1995

\*NOTE: Yamaha eliminated the use of a model year designation letter on outboard models for all units produced after April 1, 2005. For this reason, the model year designation letter is no longer included.

### New Models

<b>F</b> Fuel Induction/ Engine Type	<b>F</b> = Four Stroke <b>LF</b> = Four Stroke (Counter Rotation) <b>VF</b> = V MAX SHO® Four Stroke <b>T</b> = High Thrust Four Stroke <b>XF</b> = Extreme Thrust Offshore Four Stroke
<b>25</b> Horsepower	2.5hp to 425hp
<b>L</b> Shaft Length	<b>S</b> = 15" <b>L</b> = 20" <b>X</b> = 25" <b>U</b> = 30" <b>E</b> = 35" <b>J</b> = Jet <b>N</b> = No lower unit (LSC Models)
<b>W</b> Starting Method & Tilt Method	<b>Blank</b> = PTT & E start <b>P</b> = Power Tilt and Electric Start Only <b>E</b> = Electric Start Only <b>M</b> = Manual Start Only <b>T</b> = Power Trim and Tilt (PTT) <b>W</b> = Electric & Manual Start
<b>H</b> Control Method	<b>Blank</b> = Remote Control <b>H</b> = Tiller Handle <b>C</b> = Command Link® Control (Digital) <b>S</b> = Integrated Electric Power Steering (Digital)
<b>C</b> Generation	<b>A</b> = 1st change of motor <b>B</b> = 2nd change of motor <b>C</b> = 3rd change of motor etc.
<b>2</b> Color	<b>Blank</b> = Gray <b>2</b> = White <b>7</b> = Unpainted Cowling Sections

## The Meaning of Yamaha's Part Number

Understanding the Yamaha part number is one of the most important tasks of the Parts Department Personnel. At first glance the part number seems overwhelming. After looking closer the Yamaha Part number is very simple and easy to understand.

For example, we will use the Part number for an F150TXRD gearcase, 63P-45300-11-8D and the part number for an F150TLRD cylinder block assembly, 63P-W009B-05-9S.

### First Three Digits

The first three digits, are the model the unit is used on or if used on multiple engines it will show the first engine it was available for. **63P-45300-12-8D / 63P-W009B-02-9S.**

**63P** in both of these part numbers shows it is used on the F150. By changing **63P** to **64P (64P-45300-11-8D)** on the lower unit, the part number is now for LF150TXR. This three digit number is also the first three digits of the Primary ID of the engine.

### Middle Five Digits

The middle five digits tell what the part is. **63P-45300-12-8D 63P-W009B-05-9S.**

All lower units will have a mid-five of **45300** and all four stroke cylinder block assemblies will have **W009B**. If we change the mid five of the cylinder block to **W009A (63P-W009A-05-9S)** the part number becomes the cylinder head assembly.

### Next Two Digits

The next two digits show two different features of the part. **63P-45300-12-8D 63P-W009B-05-9S.** By changing the **-12** to a **-02 (63P-45300-02-8D)** the lower unit is now for a F150TLR (20" shaft) instead of a F150TXR (25" inch shaft). If we change the **-12** to a **-11** the part is the previous version of the F150TXR gearcase, so the part has changed during its life cycle. This is useful information if a customer complains his part doesn't fit or is different from the original.







### The Last Two Digits





The final two digits will sometimes show the paint color of the part. **63P-45300-12-8D 63P-W009B-05-9S.**

**9S** is the new color of cylinder blocks and can be used to order touch up paint from Color Rite™ paint. If the part number is for a shirt or other apparel the last two digits would tell the size. For example an extra large shirt would have **-XL** as the last two digits.



## Paint Codes

Color Example	Color Name	Paint Code	Use
	Dark Bluish Gray 1	8D	Most models exterior parts 1994 to current
	Dark Bluish Gray Metallic 2	4D	Most models internal parts 1994 to current
	Metallic Marine Silver	EK	Most models 1984 through 1993
	Shiny Black	NA	ProV, V MAX® (HPDI®) & V MAX SHO® top cowlings and lower units from 1991 to current
	Marine Dark Silver	NG	ProV top cowlings and lower units 1986 - 1990
	White Pearlescent	CE	V6 & V8 Offshore 2018 to Current

Color Example	Color Name	Paint Code	Use
	Metallic Marine Blue	EJ	C and CV models 1989 - 1993
	Harbor White	EL	L and X Shaft High Thrust Four Stroke 9.9 models 1985 - 1993 and on all Aluminum Props
	Low Gloss Black	98	Painted Stainless Steel Propellers
	Dark Gray Solid	9S	Under cowling parts, phased in starting late 2006 ~ current
	Dark Bluish Gray Solid 9	1S	Under cowling parts in 2000 & phased out by 03/2008

For part numbers see section 8 "Oils and Lubes"



Example	Where Used	Color Code	Part Number
A	4.2L OffShore Engine Exterior Parts	8D	ACC-MRNPA-IT-8D
B	V MAX SHO® Top Cowlings and Lower Units	NA	ACC-MRNPA-IT-NA
C	Top Cowlings and Lower Units Pearlescent White Base Pearlescent Clear Coat	CE CB	ACC-MRNPT-0C-EA ACC-MRNPT-0C-EB
D	Painted Stainless Propellers	98	
E	Aluminum Propellers	EL	



## Outboard Genuine Parts Limited Warranty

### YAMAHA MOTOR CORPORATION, U.S.A. OUTBOARD GENUINE PARTS AND ACCESSORIES LIMITED WARRANTY

Yamaha Motor Corporation, U.S.A. hereby warrants to the first retail purchaser that each new genuine Yamaha outboard replacement part or accessory purchased from an authorized Yamaha Outboard dealer in the United States will be free from defects in material or workmanship for the period of time stated herein, subject to certain stated limitations.

**PERIOD OF WARRANTY.** Any new Yamaha outboard part, accessory, instrument, or gauge purchased by a consumer from an authorized Yamaha Outboard dealer for pleasure use in the United States, will be warranted against defects in material or workmanship for a period of one (1) year from the date of purchase, subject to the exclusions and terms and conditions noted herein. Any new Yamaha outboard part, accessory, instrument, or gauge purchased by a consumer from an authorized Yamaha Outboard dealer and utilized for commercial use (including, but not limited to, government use and rental use) in the United States, will be warranted against defects in material or workmanship for a period of ninety (90) days from the date of purchase, subject to the exclusions and terms and conditions noted herein. Replacement Yamaha outboard electrical components will be warranted against defects in material or workmanship for a period of thirty (30) days from the date of purchase, subject to the exclusions and terms and conditions noted herein. Yamaha apparel will be warranted against defects in material and workmanship for a period of ninety (90) days from the date of purchase, subject to the exclusions and terms and conditions noted herein.

**DURING THE PERIOD OF WARRANTY** any authorized Yamaha Outboard dealer will, free of charge, repair or replace, at Yamaha's option, any outboard part, accessory, instrument, or gauge adjudged defective by Yamaha due to faulty workmanship or material from the manufacturer, subject to the exclusions and terms and conditions noted herein. Repaired or replaced outboard parts, accessories, instruments or gauges will be warranted for the balance of the original warranty period. All outboard parts, accessories, instruments or gauges replaced under warranty become the property of Yamaha Motor Corporation, U.S.A.

**GENERAL EXCLUSIONS.** This warranty will not cover failures or damage caused by abuse or neglect, including but not limited to the following:

1. Improper installation, or use in an application other than that for which the outboard part, accessory, instrument, or gauge was designed/intended;
2. Abnormal strain, neglect, or abuse;
3. Racing use;
4. Lack of proper maintenance or off season storage;
5. Incompatible fuels, lubricants or filtration;
6. Accident or collision damage or contact with foreign objects;
7. Modification to original parts;
8. Water submersion and/or ingestion;
9. Normal deterioration;
10. Growth of marine organisms on component surfaces;
11. Non-compliance with any applicable owner's manual, service manual and/or instructional booklet.

Effective Date: January 1, 2008 08-165

**SPECIFIC EXCLUSIONS.** This warranty will not cover the following:

1. Cost of labor for replacement of a defective outboard part, accessory, instrument, or gauge;
2. Expenses for towing, slip fees, loss of income, and/or haul-out, or any other expense related to the failure of the warranted part, accessory, instrument, or gauge;
3. Replacement of parts, accessories, instruments, or gauges for routine maintenance or normal wear and/or tear;
4. Parts, accessories, instruments or gauges covered by other manufacturer's warranty provisions, or parts, accessories, instruments or gauges replaced as part of a Yamaha Warranty or Yamaha Extended Service (Y.E.S.) repair.

**OBTAINING REPAIRS UNDER WARRANTY.** To receive a repair or replacement of an outboard part, accessory, instrument, or gauge under the terms of this warranty, a valid sales receipt must be presented to any authorized Yamaha Outboard dealer, along with the outboard part, accessory, instrument, or gauge, within 10 days of the discovery of the failed outboard part, accessory, instrument, or gauge.

**THE CUSTOMER'S RESPONSIBILITY.** Under the terms of this warranty, the customer will be responsible for ensuring that the outboard part, accessory, instrument, or gauge was used in the manner that it was designed/intended, it was installed and used properly subject to any applicable owner's manual, service manual or instructional booklet and that all necessary maintenance was performed. The customer must pay all labor charges, if any, if an authorized Yamaha Outboard dealer or other servicing entity must remove and/or replace the outboard part, accessory, instrument and/or gauge.

**YAMAHA MOTOR CORPORATION, U.S.A. MAKES NO OTHER WARRANTY OF ANY KIND, EXPRESSED OR IMPLIED. ALL IMPLIED WARRANTIES OF MERCHANTABILITY AND FITNESS FOR A PARTICULAR PURPOSE WHICH EXCEED THE OBLIGATIONS AND TIME LIMITS STATED IN THIS WARRANTY ARE HEREBY DISCLAIMED BY YAMAHA MOTOR CORPORATION U.S.A. AND EXCLUDED FROM THIS WARRANTY.**

**SOME STATES DO NOT ALLOW LIMITATIONS ON HOW LONG AN IMPLIED WARRANTY LASTS, SO THE ABOVE LIMITATIONS MAY NOT APPLY TO YOU. ALSO EXCLUDED FROM THE WARRANTY ARE ANY INCIDENTAL OR CONSEQUENTIAL DAMAGES, INCLUDING LOSS OF USE. SOME STATES DO NOT ALLOW THE EXCLUSION OR LIMITATION OF INCIDENTAL OR CONSEQUENTIAL DAMAGES, SO THE ABOVE EXCLUSION MAY NOT APPLY TO YOU.**

**THIS WARRANTY GIVES YOU SPECIFIC LEGAL RIGHTS, AND YOU MAY ALSO HAVE OTHER RIGHTS WHICH VARY FROM STATE TO STATE.**



YAMAHA MOTOR CORPORATION, U.S.A.  
Post Office Box 6555  
Cypress, California 90630

PowerMatched® System Limited Warranty

General Information  
 Rigging Estimate Guide (Diagrams)  
 Rigging Components  
 Electrical Components  
 Engine Accessories  
 Propellers  
 Maintenance Items  
 Yamaha & Trailer Supplies  
 Accessories & Apparel

**YAMAHA MOTOR CORPORATION, U.S.A.  
 POWERMATCHED® SYSTEM LIMITED WARRANTY**

Yamaha Motor Corporation, U.S.A. hereby warrants that any new Yamaha PowerMatched System when, as noted below, installed new with the purchase of a new Yamaha outboard motor, will be free from defects in material and workmanship for the period of time stated herein, subject to certain stated limitations.

**POWERMATCHED SYSTEM EXPLANATION**

All of the following products combined are collectively defined as a PowerMatched System when attached to a new Yamaha outboard motor purchased from an authorized Yamaha Outboard Motor Dealer\*.

- Yamaha Remote Control Box
- Yamaha Key Switch
- Yamaha 10 Micron or "mini-10" Fuel/Water Separator Filter
- Yamaha Boat Mounted Harnesses
- Yamaha Throttle and Shift Cables (not applicable to digital electronic control models)
- Yamaha Gauges \*\*

\* Complete PowerMatched System must be installed prior to warranty registration of the new Yamaha outboard motor or upon re-power of an existing vessel with a new Yamaha outboard motor.

\*\* The complete PowerMatched System is all of the components listed above, except for boats intended for freshwater operation, in which case the customer can opt out of the Yamaha Gauges (but not any of the other listed components) and still be eligible for the Yamaha PowerMatched System Limited Warranty coverage terms.

**PERIOD OF WARRANTY**

The PowerMatched System, when purchased new and installed along with a new Yamaha outboard motor that is registered with Yamaha Motor Corporation, U.S.A., for use in the United States, will carry the same length of warranty, commencing date of purchase, as contained in the applicable Yamaha Outboard Motor Limited Warranty Statement, subject to the exclusions noted herein. The period of time for each Yamaha Outboard Motor Limited Warranty is:

- Four stroke outboard, pleasure use: 3 years
- Four stroke outboard, government use: 3 years
- Four stroke outboard, commercial use: 1 year
- Two stroke outboard, pleasure use: 2 years
- Two stroke outboard, government use: 1 year
- Two stroke outboard, commercial use: 1 year
- V MAX® Series 2 two stroke outboard, pleasure use: 3 years
- V MAX® Series 2 two stroke outboard, government use: 1 year
- V MAX® Series 2 two stroke outboard, commercial use: 1 year

The details, terms, and conditions for each Yamaha Outboard Motor Limited Warranty Statement are specific and a part of the Statement of Warranties for those specific outboards.

**WARRANTY REGISTRATION**

To be eligible for warranty coverage, the outboard motor with PowerMatched System must be registered with Yamaha Motor Corporation, U.S.A. Warranty registration can be accomplished by any authorized Yamaha Outboard Motor Dealer. Upon receipt of the registration, an Owner's Warranty Card will be sent by Yamaha to the registered purchaser along with a copy of this Limited Warranty Statement.

**OBTAINING REPAIRS UNDER WARRANTY**

To receive repairs under this warranty, a valid Owner's Warranty Card must be presented to an authorized Yamaha Outboard Motor Dealer. During the period of warranty, any authorized Yamaha outboard dealer will, free of charge, repair or replace, at

Yamaha's option, any parts adjudged defective by Yamaha due to faulty workmanship or material from the factory. All parts replaced will become the property of Yamaha Motor Corporation, U.S.A.

**CUSTOMER'S RESPONSIBILITY**

Under the terms of this warranty, the customer will be responsible for ensuring that the outboard motor and PowerMatched System are properly operated, maintained, and stored as specified in the applicable Owner's Manual or specified with any instruction specifically pertaining to the rigging part.

The owner of the outboard motor and PowerMatched System shall give notice to an authorized Yamaha Outboard Motor Dealer of any and all apparent defects within ten (10) days of discovery and make the outboard motor and PowerMatched System available at that time for inspection and repairs at the dealer's place of business.

**GENERAL EXCLUSIONS FROM WARRANTY**

This warranty will not cover the repair of damage if the damage is the result of abuse or neglect of the PowerMatched System. Examples of abuse and neglect include, but are not limited to:

1. Racing or competition use, abnormal strain, neglect or abuse
2. Modification of original parts
3. Lack of proper maintenance and off season storage described in the Owner's Manual, installation of parts or accessories that are not equivalent in design and quality to genuine Yamaha parts
4. Damage as a result of accidents, collisions, contact with foreign materials, or submersion
5. Growth of marine organisms on component surfaces
6. Normal deterioration
7. Improper installation, or use in an application other than that for which the part or accessory was designed
8. Failure of any component caused by connection of a non-Yamaha components to the Yamaha PowerMatched System

**TRANSFER OF WARRANTY**

Transfer of the warranty from the original purchaser to any subsequent purchaser is possible by having the outboard motor and PowerMatched System inspected by any authorized Yamaha Outboard Motor Dealer and requesting the dealer to submit a change of registration to Yamaha Motor Corporation, U.S.A. within ten (10) days of the transfer.

**YAMAHA MOTOR CORPORATION, U.S.A. MAKES NO OTHER WARRANTY OF ANY KIND, EXPRESSED OR IMPLIED. ALL IMPLIED WARRANTIES OF MERCHANTABILITY AND FITNESS FOR A PARTICULAR PURPOSE WHICH EXCEED THE OBLIGATIONS AND TIME LIMITS STATED IN THIS WARRANTY ARE HEREBY DISCLAIMED BY YAMAHA MOTOR CORPORATION, U.S.A. AND EXCLUDED FROM THIS WARRANTY.**

**SOME STATES DO NOT ALLOW LIMITATIONS ON HOW LONG AN IMPLIED WARRANTY LASTS, SO THE ABOVE LIMITATION MAY NOT APPLY TO YOU. ALSO EXCLUDED FROM THIS WARRANTY ARE ANY INCIDENTAL OR CONSEQUENTIAL DAMAGES INCLUDING LOSS OF USE. SOME STATES DO NOT ALLOW THE EXCLUSION OR LIMITATION OF INCIDENTAL OR CONSEQUENTIAL DAMAGES, SO THE ABOVE EXCLUSION MAY NOT APPLY TO YOU.**

**THIS WARRANTY GIVES YOU SPECIFIC LEGAL RIGHTS, AND YOU MAY ALSO HAVE OTHER RIGHTS WHICH VARY FROM STATE TO STATE.**

Effective Date 7/1/07  
 LIT-18790-PM-A7 10-547 9/10

YAMAHA MOTOR CORPORATION, U.S.A.  
 Post Office Box 6555, Cypress, California 90630

## Helm Master® EX PowerMatched®/Component Limited Warranty

### YAMAHA HELM MASTER® EX POWERMATCHED®/ COMPONENT LIMITED WARRANTY

Yamaha Motor Corporation, U.S.A. and Yamaha Motor Canada, Ltd., (collectively hereinafter referred to as "Yamaha"), hereby warrant that any new Yamaha Helm Master EX PowerMatched System and Helm Master EX Components when purchased and installed, as noted below, in the customer's country of residence (50 United States or Canada) will be free from defects in material and workmanship for the period of time stated herein, subject to certain stated limitations.

#### HELM MASTER EX POWERMATCHED SYSTEM

The following components identified by the asterisk (\*) are collectively and individually defined as the Helm Master EX PowerMatched System when purchased together new from an authorized Yamaha Outboard Motor Dealer, and separately when compatible with Helm Master EX Components (defined below), and attached to a Yamaha outboard motor:

- Yamaha Remote Control Box\*
- Yamaha Key Switch or EKS (Electronic Key Switch)\*
- Yamaha 10 Micron or "mini-10" Fuel/Water Separator Filter\*
- Yamaha Boat Mounted Harnesses\*
- Yamaha Gauges or Gateway\*

The following components are individually and collectively defined as Helm Master EX Components:

- Yamaha Helm Master EX BCU (Boat Control Unit)
- Yamaha Helm Master EX Electronic Steering Helm
- Yamaha Helm Master EX Autopilot/Panel
- Yamaha Helm Master EX Joystick
- Yamaha Helm Master EX DES (Digital Electronic Steering)
- Yamaha Helm Master EX GPS Unit
- Yamaha Helm Master EX Heading Sensor

The authorized Yamaha Outboard Motor Dealer must perform a Boat Package System (BPS) scan using the Yamaha Diagnostic System (YDIS) after installation to ensure all software is compatible and establish the date of installation.

#### PERIODS OF WARRANTY

1. Period of Helm Master® EX PowerMatched®/Component (collectively the "Helm Master EX System") Limited Warranty with New Outboard Motor: when purchased new and installed along with a new Yamaha outboard motor that is warranty registered with Yamaha ("Date of Original Purchase"), whether for a new vessel or as re-powering of an existing vessel, will carry the same length of time as the applicable original factory Yamaha Outboard Limited Warranty on the new Yamaha outboard motor, subject to the exclusions noted herein, commencing the Date of Original Purchase, as follows:

- XF425/F350CC outboard motor
  - o Pleasure (personal, family, household) use: 5 years
  - o United States Government use: 3 years
  - o Canada Government use: 2 years
  - o Commercial use: 1 year

A commercial application is defined as any use of the outboard motor to generate income (excluding tournament fishing) or support business operations in any way during the warranty period,

without regard to the type or percentage of commercial use. Yamaha reserves the right to modify incorrect registration data and reduce the warranty period to reflect commercial use.

- o Canada Camp use: 2 years
- o Guide use: 3 years

A Guide refers to a person who provides Yamaha-approved fishing guide services to anglers who engage in sport fishing.

- Four-stroke outboard motor (except XF425/F350CC)
  - o Pleasure use: 3 years
  - o United States Government use: 3 years
  - o Canada Government use: 2 years
  - o Commercial use: 1 year

A commercial application is defined as any use of the outboard motor to generate income (excluding tournament fishing) or support business operations in any way during the warranty period, without regard to the type or percentage of commercial use. Yamaha reserves the right to modify incorrect registration data and reduce the warranty period to reflect commercial use.

- o Canada Camp use: 2 years
- o Guide use: 3 years

A Guide refers to a person who provides Yamaha-approved fishing guide services to anglers who engage in sport fishing.

The details, terms, and conditions for each Yamaha Outboard Motor Limited Warranty Statement are specific and separate, and a part of the statement of warranties for those specific outboards.

2. Period of Helm Master EX System Limited Warranty with Previously Warranty Registered Outboard Motor: when purchased new from and installed by an authorized Yamaha Outboard Motor Dealer and attached to a previously mounted Yamaha outboard motor within its applicable original factory Yamaha Outboard Limited Warranty, will be covered for the remainder of the Yamaha Outboard Motor Limited Warranty that commenced on the Date of Original Purchase or one (1) year from the Date of Original Purchase (whichever is greater).

3. Period of Helm Master EX System Limited Warranty with No Remaining Original Factory Yamaha Outboard Limited Warranty: when purchased new from and installed by an authorized Yamaha Outboard Motor Dealer and attached to a Yamaha outboard motor that is no longer covered by the original factory Yamaha Outboard Limited Warranty, will be covered for one (1) year from the Date of Original Purchase.

#### WARRANTY REGISTRATION

For the Helm Master EX System to be eligible for warranty coverage, the outboard motor with Helm Master EX System must currently be/or have been warranty registered with Yamaha in the country of residence. Warranty registration can be accomplished by any authorized Yamaha Outboard Motor

LIT-18790-HM-22  
Effective Date: 3/15/2022  
22\_0112

## Helm Master® EX PowerMatched®/Component Limited Warranty (cont'd.)

Dealer. The required BPS scan will establish the date of Helm Master EX System installation. If the Helm Master EX System was purchased for use on a Yamaha outboard motor no longer within its original factory Yamaha Outboard Limited Warranty, the customer must keep the original proof of purchase and installation.

### OBTAINING REPAIRS UNDER WARRANTY

During the period of warranty, any authorized Yamaha Outboard Motor Dealer in the country of residence, will, free of charge, repair or replace, at Yamaha's option and sole discretion, any parts adjudged defective by Yamaha due to faulty workmanship or material from the factory. All parts replaced will become the property of Yamaha. The liability of Yamaha shall in no event exceed the actual cash value of the covered item. If the customer is temporarily using a U.S.-registered Helm Master EX System in Canada, or a Canada-registered Helm Master EX System in the U.S., and it needs warranty repairs, the customer should contact a nearby authorized Yamaha Outboard Motor Dealer for assistance. The local dealer will contact Yamaha on the customer's behalf so that needed repairs can be made as quickly as possible.

### CUSTOMER'S RESPONSIBILITY

Under the terms of this warranty, the customer will be responsible for ensuring that the outboard motor and Helm Master EX System are properly operated, maintained, and stored as specified in the applicable Owner's Manual or specified with any instruction specifically pertaining to the rigging part.

The owner of the outboard motor and Helm Master EX System shall give notice to an authorized Yamaha Outboard Motor Dealer of any and all apparent defects within ten (10) days of discovery and make the outboard motor and Helm Master EX System available at that time for inspection and repairs at the dealer's place of business.

### GENERAL EXCLUSIONS FROM WARRANTY

This limited warranty will not cover the repair of damage if the damage is the result of abuse, alteration, modification, neglect, vandalism, failure to adhere to product capacity information and/or product maintenance, care, instructions, and other items listed below. Examples of the above include, but are not limited to:

1. Racing or competition use, abnormal strain, neglect or abuse.
2. Modification of original parts.
3. Lack of proper maintenance and off-season storage described in the Owner's Manual.
4. Installation of parts or accessories that are not equivalent in design and quality to genuine Yamaha parts.
5. Damage as a result of accidents, collisions, contact with foreign materials, or submersion.
6. Damage caused by growth of marine organisms on component surfaces.
7. Damage caused by normal deterioration.
8. Improper installation, or use in an application other than that for which the part or accessory was designed.
9. Failure of any component caused by connection of a non-Yamaha component to the Helm Master EX System.
10. Acts of God or Force Majeure.
11. Damage caused by or resulting from non-compliance with Yamaha's maintenance and care instruction or other specifications.

LIT-18790-HM-22  
Effective Date: 3/15/2022  
22\_0112

### TRANSFER OF WARRANTY

Transfer of the warranty from the original purchaser to any subsequent purchasers is possible by having the outboard motor and Helm Master EX System inspected by any authorized Yamaha Outboard Motor Dealer and requesting the dealer to submit a change of outboard motor registration to Yamaha within ten (10) days of the transfer. The time period of the transferrable warranty shall only be the time period remaining upon the date of transfer, and in no event shall the transfer of a warranty extend the original time of the warranty period. The transfer of the warranty is effective upon the date Yamaha receives written notice of the transfer from an authorized Yamaha Outboard Motor Dealer. If the Date of Original Purchase of the Helm Master EX PowerMatched System or any Helm Master EX Components cannot be established by the selling Yamaha Outboard Motor Dealer using the required BPS scan, the customer must present all receipts showing proof of applicable purchase and installation dates to an authorized Yamaha Outboard Motor Dealer to determine the remaining warranty time period, if any.

***YAMAHA MAKES NO OTHER WARRANTY OF ANY KIND, EXPRESSED OR IMPLIED. ALL IMPLIED WARRANTIES OF MERCHANTABILITY AND FITNESS FOR A PARTICULAR PURPOSE WHICH EXCEED THE OBLIGATIONS AND TIME LIMITS STATED IN THIS WARRANTY ARE HEREBY DISCLAIMED BY YAMAHA AND EXCLUDED FROM THIS WARRANTY.***

***SOME STATES/PROVINCES DO NOT ALLOW LIMITATIONS ON HOW LONG AN IMPLIED WARRANTY LASTS, SO THE ABOVE LIMITATION MAY NOT APPLY TO YOU. ALSO EXCLUDED FROM THIS WARRANTY ARE ANY INCIDENTAL OR CONSEQUENTIAL DAMAGES INCLUDING LOSS OF USE, LOSS OF TIME AND INCONVENIENCE. YAMAHA'S LIABILITY IS LIMITED TO REPAIRING OR REPLACING THE HELM MASTER EX SYSTEM AS PROVIDED IN THIS WARRANTY. SOME STATES/PROVINCES DO NOT ALLOW THE EXCLUSION OR LIMITATION OF INCIDENTAL OR CONSEQUENTIAL DAMAGES, SO THE ABOVE EXCLUSION MAY NOT APPLY TO YOU.***

***THIS WARRANTY GIVES YOU SPECIFIC LEGAL RIGHTS, AND YOU MAY ALSO HAVE OTHER RIGHTS WHICH VARY FROM STATE TO STATE AND/OR PROVINCE TO PROVINCE.***

THIS DOCUMENT CONTAINS THE ENTIRE WARRANTY GIVEN BY YAMAHA AND THERE ARE NO TERMS, PROMISES OR CONDITIONS OR WARRANTIES OTHER THAN THOSE CONTAINED HEREIN. NO ORAL OR WRITTEN INFORMATION OR ADVANCE GIVEN BY YAMAHA, ITS DEALERS, REPRESENTATIVES, AGENTS OR EMPLOYEES SHALL CREATE A WARRANTY BY YAMAHA OR IN ANY WAY INCREASE THE SCOPE OF THIS WARRANTY.

USA CUSTOMERS:  
Yamaha Motor Corporation, U.S.A.  
1270 Chastain Road  
Kennesaw, GA 30144  
(866) 894-1626

CANADIAN CUSTOMERS:  
Yamaha Motor Canada, Ltd.  
480 Gordon Baker Road  
Toronto, Ontario M2H 3B4  
(416) 498-1911

## How to Navigate the Parts Tab in YMBS

The Parts Tab in YMBS is the dealer's main source of information and interaction with Marine Rigging and Parts (MRP).

Once you click on the Parts tab, the very first thing that becomes visible is also one of the most important. The picture below shows an example of parts messages. These messages contain information about programs, pricing, new products, and other valuable information. Under the Parts tab, Quick Links have been added for your convenience. A dealer can check availability, place a parts order, import a parts order, launch Parts Manager Pro™ and access the Marine Rigging and Parts live chat.

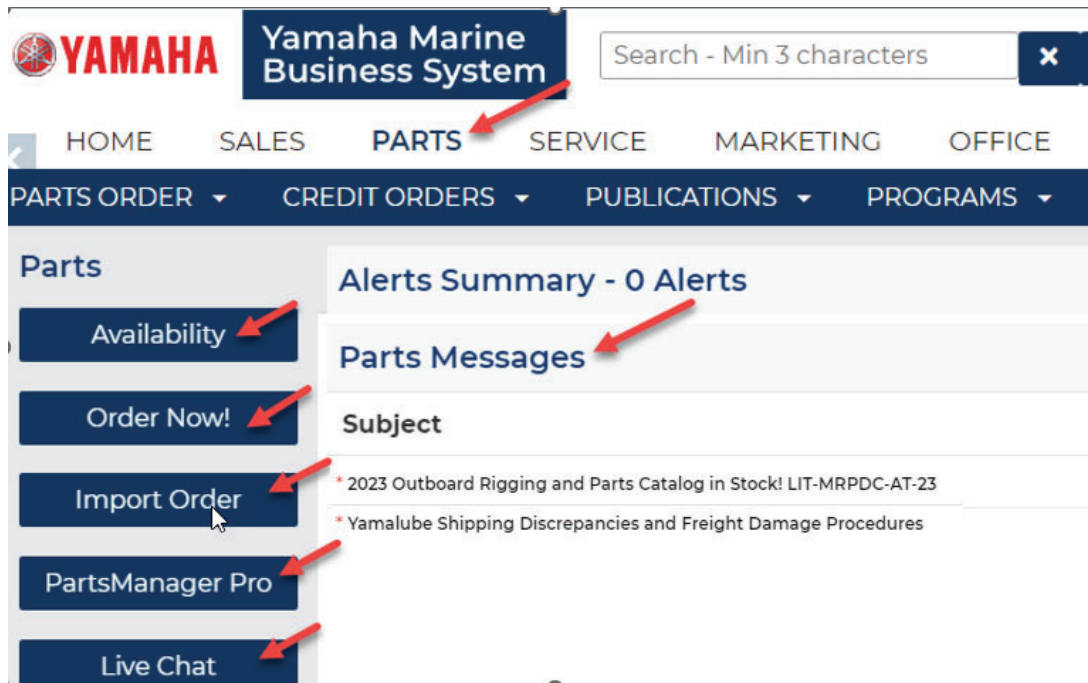

❑ Please find these helpful tools under “Parts Order”, “Order Instructions and Videos”.

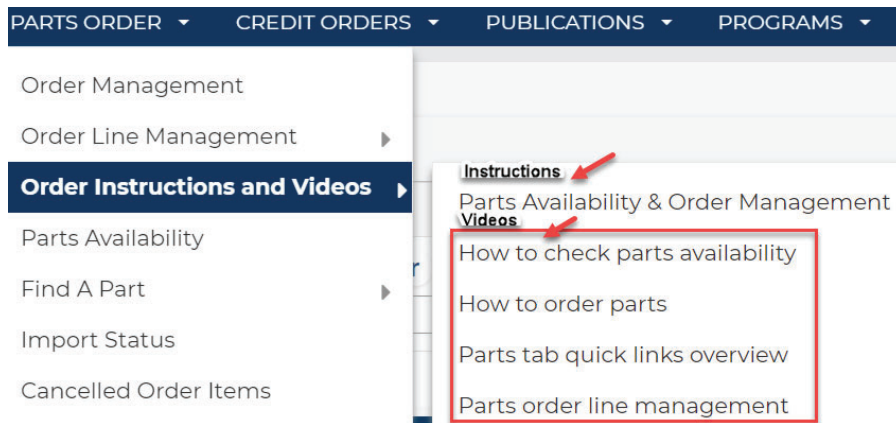

## Checking Parts Availability

- ❑ The Parts Availability Screen (shown Below) will provide you with the current available inventory.
- ❑ Part numbers can be manually typed in, copied and pasted (CNTRL-V) from an Excel spreadsheet, or manually searched. Click Search or Enter on your keyboard to begin your search.
- ❑ You will now see your part number and supersession (if applicable), dealer cost, retail cost and availability. JP = Japan and DS = Drop Ship inventory

**Parts Lookup**

Search

**Note: If a part number supersedes you will see a new line added and an asterisk in front of the new part number.**

Part Number	Description	Pack Qty	ESD	Status	Cost	Retail	CA	WI	GA	Warehouse	
										JP	DS
5GH134400000	OIL ELEMENT ASSY	0		Superseded	7.39	12.49	00	00	00	00	00
*5GH134407100	ELEMENT ASSY, OIL CLEANER	0		Active	8.49	14.99	00	00	00	10+	00
		0.000			0.00	0.00	00	00	00	00	00

- ❑ Click inside a blank box to find the tiny search button.
- ❑ There are several options to search parts by. This feature allows for part number searches to find similar parts by the MID 5 option.
- ❑ Asterisks (\*) can be used as a wildcard for searching.

**Parts Lookup**

Search

Part Number	Description
5GH134400000	OIL ELEMENT ASSY
*5GH134407100	ELEMENT ASSY, OIL CLEANER
MARMTRCVF420	COWLING COVER 42L DEC-DES
MAR10MEL0000	10MM FUEL FLTR ELEMENT

**Search: Part Number** Personal Value List Hide Search Criteria ?

Further Search Helps: Search by Printed Part

Search by Part Description  
Search by Part Number  
Search by MID5  
Search by Printed Part

Printed Part Number

Maximum Number of Results:

## Order Management Screen – Placing a Parts Order

- The Order Management screen is where you can place a new order and manage existing orders. You can also place a new order by using the Quick Link – Order Now option.
- To initiate Order Management:
  - From the Parts tab, select **“Parts Order”** menu to view the drop-down list. Select **“Order Management”** option from the drop-down list

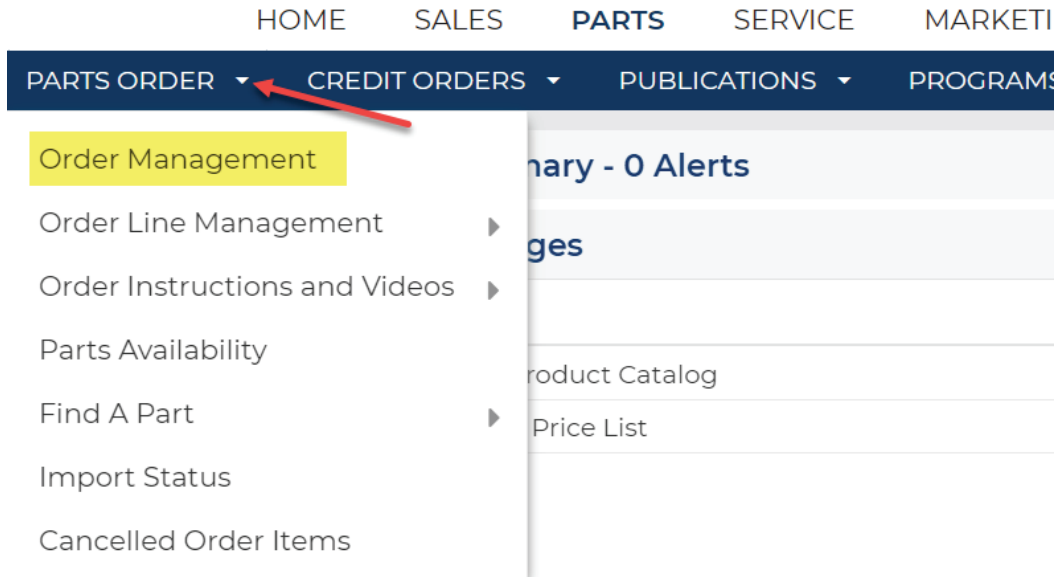

Click **“CREATE NEW ORDER”** or **“IMPORT ORDER”**

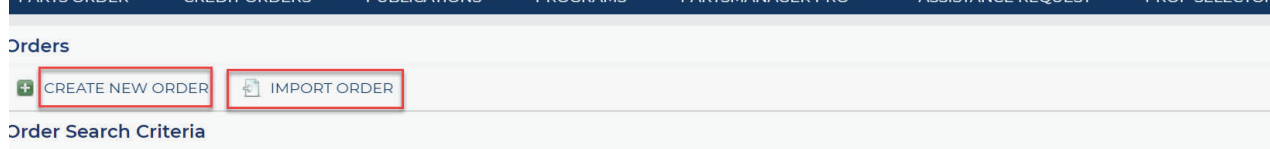

- If you select **“Import Order”** you will be prompted to select the sales program code and **“Choose File”** before clicking **“Import”**.

## Order Management Screen – Placing a Parts Order

**Import Parts Order**

Action	ID	Description	Start Effective Date	End Effective Date
	STANDARD	Standard Sales Program(STD)		
		Note : Your dealership will be charged freight on orders under \$250 or orders that contain Yamalube products. Use the appropriate Sales program code to order your yamalube products.		
	MRP_DAILY	Marine-Rigging-Parts-Oil Daily PGM		
		Note : Your dealership will be charged freight on orders under \$500.		
	EKYAMALUBE	"Exclusive Yamalube Service Dept" Prog	01/01/2010	12/31/2999
	SIREN_2023	Siren_2023 Siren Marine Sales Program	12/01/2022	03/01/2023

Ship Date: 01/24/2023    File Path: Choose File No file chosen

**Validate Import Records**

Header Record

FCODE	Batch Code	Back Order Indicator	Alternate Warehouse Indicator	Freight Code	Dealer Reference
H	21073015460101	Y			

Sales Program : Standard Sales Program

Click "Process without Errors" to proceed.

Following records have errors. Please correct them and click 'Re-Validate' button. Or you can proceed without these records by clicking 'Process without Errors' Button

FCO...	Part Number	Quantity	Account Line Part Number	Status
A	42SF816X0000	1	..	Part blocked for Order Creation!
A	904802280200	1	..	Part blocked for Order Creation!
A	16BF38290000	1	..	Part blocked for Order Creation!
A	16BF471M0000	1	..	Part blocked for Order Creation!
A	16BF196U0000	1	..	Part blocked for Order Creation!

This section shows the part numbers that did not get uploaded.  
 The part numbers can be re-entered/adjusted on this screen.  
     ▪ Click "Re-Validate" button.  
 This information can be exported to Excel.

Quantity for Following Records is Adjusted to the nearest rounding figure

FCO...	Part Number	Quantity	Account Line Part Number	Status
A	B42F17190000	10	..	Quantity Changed From 4 to 10.
A	901830681100	10	..	Quantity Changed From 4 to 10.
A	5UGK75890000	7	..	Quantity Changed From 4 to 7.

Part numbers rounded up to minimum sales quantity.

**Create Parts Order**

Header

Sales Program: Standard Sales Program(STD)    Reference Order No:      \* Ship To:

\* Dealer PO no. / Reference:     \* Backorder OK?: Yes    \* Payment Terms: Due on 15th of next month    CARSON CITY,NV,89701-6321,US

Default Prepaid Freight:  FEDERAL EXPRESS GROUND    \* Requested Delivery: 07/27/2021

Shipping Options Dealer Collect (Optional):

If you are manually inputting an order you will need to input a PO number before you can add parts.

Item

Item	Part Number	Order quantity	Des	Number	Quantity	Delivery	Cost	Subtotal	CA	GA	WI	Backorder	Dropship	JP
000100		0				07/27/2021	0.00	0.00	0.00	0	0	0	0	0

Total Price: 0.00 USD

General Information  
 Rigging Estimate Guide (Diagrams)  
 Rigging Components  
 Electrical Components  
 Engine Accessories  
 Propellers  
 Maintenance Items  
 Yamalube & Trailer Supplies  
 Accessories & Apparel



## Order Management Screen – Placing a Parts Order

**Create Parts Order**

Input a previous created sales order number and click "Copy Order" to copy/clone the order.

You can change the sales program code before clicking "Submit"

Submit Save Close

Change Sales Program Sales Program: Standard Sales Program(STD)  
 \* Dealer PO no. / Reference: BluCru4life  
 Default Prepaid Freight:  FEDERAL EXPRESS GROUND  
 Shipping Options Dealer Collect (Optional):

Reference Order No:  Copy Order

\* Backorder OK?: Yes  
 \* Payment Terms: Due on 15th of next month  
 \* Requested Delivery: 07/27/2021

\* Ship To:

If available, you can change the authorized Ship To address here.

Export to Excel Summarized Shipping Print Cutoff Times

Item

Validate Campaign Parts

Add Line Clear Lines Delete Line

Total Price: 0.00 USD

Item	Part Number	Order quantity	Description	Customer Part Number	Split Quantity	Requested Delivery	Line Reference	Retail	Unit Cost	Subtotal	CA	GA	WI	Backorder	Dropship	JP
000100		0				07/27/2021		0.00	0.00	0.00	0	0	0	0	0	0
000200		0				07/27/2021		0.00	0.00	0.00	0	0	0	0	0	0
000300		0				07/27/2021		0.00	0.00	0.00	0	0	0	0	0	0

Total Cost is above \$250. Your dealership will not be charged freight

Submit Save Close

**Header**

Change Sales Program Sales Program: Standard Sales Program(STD)  
 \* Dealer PO no. / Reference: 100 line test  
 Shipping Options Default Prepaid Freight:  FEDERAL EXPRESS GROUND  
 Dealer Collect (Optional):

Reference Order No:  Copy Order

\* Ship To: 20007459

\* Backorder OK?: Yes  
 \* Payment Terms: Due on 15th of next month  
 \* Requested Delivery: 07/31/2021

Part numbers starting with 90891\* will require a validate VIN# or PID#.

Note : Items coming from Japan that fit older models (10+years) could take up to 60 days to arrive at your business.

Export to Excel Summarized Shipping Print Cutoff Times

Item

Validate Campaign Parts

Clear Lines Delete Line

Total Price: 518.57 USD

Item	Part Number	Description	Customer Part Number	Order quantity	Split Quantity	Requested Delivery	Line Reference	Retail	Unit Cost	Subtotal	CA	GA	WI	Backorder	Dropship	JP
000100	16B251850...	RING 1		4		07/31/2021		2.50	1.38	5.52	4	0	0	0	0	219
000200	1TD167740...	WASHER		4		07/31/2021		2.35	1.51	6.04	4	0	0	0	0	265
000300	1XD1541A...	STAY CRANKCASE COVER 1		4		07/31/2021		1.60	1.02	4.08	0	0	0	4	0	16

## Order Management Screen – Placing a Parts Order

Total Cost is above \$250. Your dealership will not be charged freight

Submit Save Close

Header

Change Sales Program Sales Program: Standard Sales Program(STD) Reference Order No: Copy Order Ship To: 20007459

Dealer PO no. / Reference: 100 line test Backorder OK?: Yes

Order line quantities can be split by date  
 Click on the "Split Quantity" icon  
 Input adjusted quantities and shipping dates  
 Click "Update" when complete

Splitting Part 5GH134408000 For Quantity 10

Material	Order quantity	Request.div.dt
5GH134408000	5	12/08/2022
5GH134408000	5	02/09/2022
5GH134408000	0	12/08/2022
5GH134408000	0	12/08/2022
5GH134408000	0	12/08/2022
5GH134408000	0	12/08/2022
5GH134408000	0	12/08/2022
5GH134408000	0	12/08/2022
5GH134408000	0	12/08/2022
5GH134408000	0	12/08/2022
5GH134408000	0	12/08/2022

Update Cancel

Item	Part Number	Description	Customer Part Number	Order quantity	Split Quantity	Requested Delivery	Line Reference
000100							
000200							
000300							
000400							
000500							
000600							
000700							
000800							

Total Cost is above \$250. Your dealership will not be charged freight

Submit Save Close

Header

Change Sales Program Sales Program: Standard Sales Program(STD) Reference Order No: Copy Order Ship To: 20007459

Dealer PO no. / Reference: 100 line test Backorder OK?: Yes

Click "Save" if you are not ready submit the order to Yamaha.  
 This screen will timeout if it remains idle too long.

Shipping Options Default Prepaid Freight:  FEDERAL EXPRESS GROUND Dealer Collect (Optional):

Note : Items coming from Japan that fit older models (10+years) could take up to 60 days to arrive at your business.

Export to Excel Summarized Shipping Print Cutoff Times

Item

Validate Campaign Parts

Clear Lines Delete Line

Total Price: 518.57 USD

Item	Part Number	Description	Customer Part Number	Order quantity	Split Quantity	Requested Delivery	Line Reference	Cost										
								Retail	Unit Cost	Subtotal	CA	GA	WI	Backorder	Dropship	JP		
000100	16B251850...	RING 1		4		07/31/2021		2.50	1.38	5.52	4	0	0	0	0	0	219	
000200	1TD167740...	WASHER		4		07/31/2021		2.35	1.51	6.04	4	0	0	0	0	0	265	
000300	1XD1541A...	STAY, CRANKCASE COVER 1		4		07/31/2021		1.60	1.02	4.08	0	0	0	4	0	0	16	
000400	1XD2837G...	LOCK 1		4		07/31/2021		2.00	1.10	4.40	4	0	0	0	0	0	871	

## Editing a Draft Order

- Once you click change you can edit your order. While your order is still in Draft mode you can also edit the Sales Program Code.

Orders

Click blue order number hyperlink to edit your draft order.

Click "Refresh" if you do not see your recently saved order.

Order Number Date Range / Status

Order #: Type: Create Date: 01/20/2023

Purchase Order Number Status: All End Date: 01/24/2023

PO #: SEARCH REFRESH CLEAR

Matching Orders (Click the Refresh button to see New Orders)

#	Order Date	Order Number	Program Code	Purchase Order Number	Status	Net Sales Amount	Order Created By
1	01-20-2023		STANDARD	16799	Complete	\$39.75	Dealership
2	01-18-2023		STANDARD	16768	Complete	\$185.43	Dealership
3	01-18-2023		MRP_DAILY	41059	Complete	\$54.55	Dealership

General Information  
 Rigging Estimate Guide (Diagrams)  
 Rigging Components  
 Electrical Components  
 Engine Accessories  
 Propellers  
 Maintenance Items  
 Yamaha & Trailer Supplies  
 Accessories & Apparel

## Editing a Draft Order

**Display Parts Order : 0210039510**

Close Delete **Change** Print

**Header**

Sales Program: Standard Sales Program      Created On: 07/30/2021      Ship To: 20007459  
 Order #: 210039510      Changed On:      Overall Status: Draft  
 Dealer PO no. / Reference: 100 line test      Backorder OK?: Yes  
 Freight: FEDERAL EXPRESS GROUND      Payment Terms: Due on 15th of next month  
 Requested Delivery: 07/31/2021

Click "Change" to edit your draft order.

Expand Shipping Details Collapse Shipping Details

**Line Level Information**

Line #	Part Number	Description	Warranty PID	Quantities			Requested Delivery	Line Reference	Shipping Details	Retail	Total Standard Cost: 518.57 USD		Total Net Cost: 518.57 USD	
				Ordered	Confirmed	Cancelled					Standard Cost	Net Cost		
000100	16B251850000	RING 1		4	0	0	07/31/2021		2.50	1.38	5.52	1.38	5.52	
000200	1TD167740000	WASHER		4	0	0	07/31/2021		2.35	1.51	6.04	1.51	6.04	
000300	1XD1541A0000	STAY, CRANKCASE COVER 1		4	0	0	07/31/2021		1.60	1.02	4.08	1.02	4.08	
000400	1XD2837G0000	LOCK 1		4	0	0	07/31/2021		2.00	1.10	4.40	1.10	4.40	
000500	1XDF151K1000	LABEL 7		4	0	0	07/31/2021		1.85	1.26	5.04	1.26	5.04	
000600	1XDF15581000	LABEL, WARNING 2		4	0	0	07/31/2021		2.45	1.55	6.20	1.55	6.20	
000700	1XDF31650000	WASHER		4	0	0	07/31/2021		1.60	1.09	4.36	1.09	4.36	

## Order Line Management Screen

- The Order Line Management screen helps in managing existing orders.
- To initiate Order Line Management:
  - From the Parts tab, select the "Parts Order" menu to view the drop-down list.
  - Select the "Order Line Management" option and then click one of the 6 options.

PARTS ORDER ▾ CREDIT ORDERS ▾ PUBLICATIONS ▾

- Order Management
- Order Line Management ▸**
  - Detailed Order Search
  - Open / Scheduled
  - Backordered
  - Future
  - Shipped
  - Cancelled
- Order Instructions ▸
- Parts Availability
- Find A Part ▸
- Import Status
- Cancelled Order Items

## Order Line Management Screen

### ❑ Detailed Order Search

- User can search by **Open Order #**, **PO #**, **Part #** or **Order Status**

Yamaha Marine Business System

HOME SALES PARTS SERVICE MARKETING OFFICE FINANCE CSI EDUCATION KNOWLEDGE CENTER

PARTS ORDER CREDIT ORDERS PUBLICATIONS PROGRAMS PARTSMANAGER PROM ASSISTANCE REQUEST PROP SELECTOR LIVE CHAT

Detailed Order Search

Order Number  
Order #:

Purchase Order Number  
PO #:

Part Number / Status  
Type: All Parts  
Part #:

Status: Open

Start Date: 12/24/2022  
End Date: 01/24/2023

SEARCH REFRESH CLEAR

Matching Order Lines

Status: Open  
Open  
BackOrdered  
Future  
Shipped  
Cancelled

Search can also be refined by inputting date parameters.

### ❑ Cancelled

- Users will now see an alert on the **Parts** homepage whenever an order line is cancelled. The alert will be displayed for 5 days after cancellation.

Alerts Summary - 0 Alerts

Parts Messages

Subject

Cancelled Parts Orders - You have 3 cancelled parts orders

Yamalube Shipping Discrepancies and Freight Damage Procedures

PARTS ORDER CREDIT ORDERS

Order Management  
Order Line Management  
Order Instructions  
Parts Availability  
Find A Part  
Import Status  
Cancelled Order Items

- Click the **hyperlink** to view cancelled orders or
- Click Cancelled Order Items under the Order tab to view a complete list of cancelled items.

### ❑ Open / Scheduled

- Displays all related items

Yamaha Marine Business System

HOME SALES PARTS SERVICE MARKETING OFFICE FINANCE CSI EDUCATION KNOWLEDGE CENTER

PARTS ORDER CREDIT ORDERS PUBLICATIONS PROGRAMS PARTSMANAGER PROM ASSISTANCE REQUEST PROP SELECTOR LIVE CHAT

Open Order Lines

Matching Order Lines

Order D.	Sales Order #	Sales Promotion Co.	PO#	Line #	Part #	Net Price	Description	Quantity	Warehouse
10-10-2022	23H8FFB#P#0		16349	002070	48933A400L	\$9.31	ELEMENT ASSEY OIL CLEANER	12	Cypress
10-10-2022	23H8FFB#P#0		16349	002070	N2934A00L	\$9.22	ELEMENT ASSEY OIL CLEANER	60	Cypress
10-08-20	STANDARD		16332	000000	LTYVDSHAR	\$272.95	SMART YD6L	1	Cypress
09-29-20	STANDARD		16279	000000	HAARCABLEL	\$4.10	PREMIER II CABLE 1/6 FOOT	2	Cypress
08-02-20	MRP_DAILY		15883	00001	HAAR0HELO	\$13.54	10M FUEL FLTR ELEMENT	102	Cypress
11-03-2021	STANDARD		14640	00001	6V7835A09F	\$84.80	PRO SERIES II TACH WHHT	1	Cypress
09-02-20	STANDARD		NEWBURY	00001	HAARCTWAY	\$275.00	6V6 GATEWAY KIT	1	Cypress
09-02-20	STANDARD		13771	000070	HAARVTS5W	\$71.85	REMOTE VAR RPM SW KIT	3	Wenness

### ❑ Backordered

- Displays all related items

Yamaha Marine Business System

HOME SALES PARTS SERVICE MARKETING OFFICE FINANCE CSI EDUCATION KNOWLEDGE CENTER

PARTS ORDER CREDIT ORDERS PUBLICATIONS PROGRAMS PARTSMANAGER PROM ASSISTANCE REQUEST PROP SELECTOR LIVE CHAT

Backordered Lines

Matching Order Lines

Order D.	Sales Order #	Sales Promotion Code	PO#	Line #	Part #	Net Price	Description	Quantity
10-10-2022	23H8FFB#P#0		16349	002070	N2934A00L	\$9.22	ELEMENT ASSEY OIL CLEANER	60
10-08-20	STANDARD		16332	000000	LTYVDSHAR	\$272.95	SMART YD6L	1
09-29-20	STANDARD		16279	000000	HAARCABLEL	\$4.10	PREMIER II CABLE 1/6 FOOT	2
08-02-20	MRP_DAILY		15883	00001	HAAR0HELO	\$13.54	10M FUEL FLTR ELEMENT	102
11-03-2021	STANDARD		14640	00001	6V7835A09F	\$84.80	PRO SERIES II TACH WHHT	1
09-02-20	STANDARD		NEWBURY	00001	HAARCTWAY	\$275.00	6V6 GATEWAY KIT	1
09-02-20	STANDARD		13771	000070	HAARVTS5W	\$71.85	REMOTE VAR RPM SW KIT	3

# General Information

## Order Line Management Screen

### Future

- Displays all related items

### Shipped

- Displays items shipped within the past month

- To broaden your Shipped range you can click on Expand/Collapse and the Detailed Search box will appear. You can change the date range for your shipped search. The date selection must be within a 12 month date range. You can access invoices and tracking numbers by clicking on the hyperlink.

### Cancelled

- Displays items cancelled within the past 3 months

## Order Line Management – Canceling an Order Line

- The **Detailed Order Search** criteria has a Backorder **Cancel** button
- A backorder with the **STANDARD** sales program is eligible for dealer cancellation.
- Contact your Inside Sales Rep. in order to cancel all other sales program orders or third-party line items.

After you make your selections, press cancel selections on the top right

Order D.	Sales Order #	Sales Promotion Co.	PO#	Line #	Part #	Net Price	Description	Quantity			Warehouse	Order ST.
								Orde...	Confir...	Shipped		
<input type="checkbox"/>	01-23-2023	EXYAMALLUBE	20230123025	000100	LU/B10W30F	\$800.68	10W30 MARINE FC-W 55GL DRUM	1	1	0	Kennesaw	In Process
<input checked="" type="checkbox"/>	01-23-2023	STANDARD	20230123024	003710	97E9508535	\$0.88	BOLT, HEXAGON W/W DEEP RECESS	1	1	0	Cypress	Backorder
<input checked="" type="checkbox"/>	01-23-2023	STANDARD	20230123024	000210	9079446911	\$25.81	ELEMENT 10 MICRON LG TYPE	1	0	0	Kennesaw	Backorder
<input checked="" type="checkbox"/>	01-23-2023	STANDARD	20230123024	001210	9026906020	\$0.31	RIVET	15	0	0	Kennesaw	Backorder

### Find a Part

- Find a Part is a feature to assist dealers in finding a part or parts that may be on back order or obsolete with Yamaha.
- From the Parts Tab, select the **"Parts Order"** menu to view the drop-down list. There are three options under Find a Part
  - Request Add: Allows dealer to add a request for a part they are looking for.
  - Open Requests: Shows a sortable list of all the active requests your dealership has entered. Your dealership can view this list and offer parts to those in need through the reply link.
  - My Requests: Provides a list of your dealership part requests. Your dealership can edit and remove requests from this screen.

## Credit Orders

- Under the PARTS landing page
- Select the “Credit Orders” drop down
- Select “Parts Return”
- The Marine Obsolescence Program “OBS” is offered one time a year. A message will be posted on YMBS under the Parts Sales Messages when the program is available.
- See “Credit Instructions and Video” for further assistance.
- Yamaha Marine Rigging and Parts will accept returns up to 90 days from the date of invoice. If a part was invoiced over 90 days ago, the part cannot be returned.

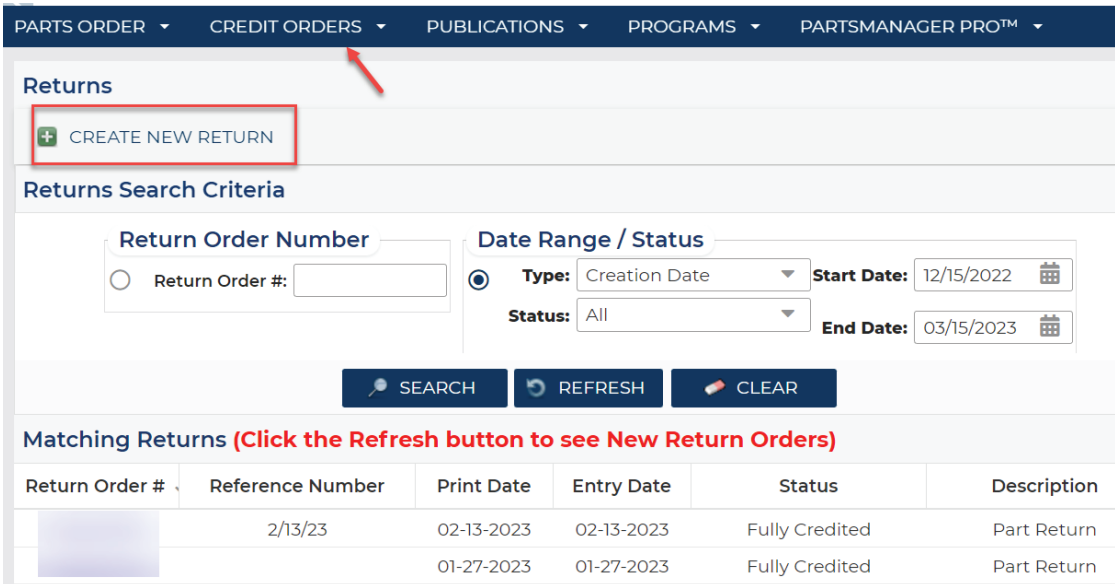
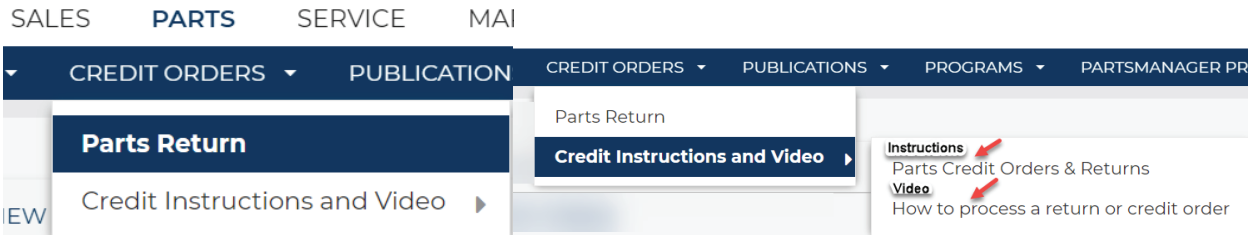

## Returns Management: Search Criteria

The **Returns Search Criteria** screen allows you to search for a Return Order by providing one of the following search criteria:

- Return Order Number
- Date Range / Status

Confirm your **Start Date** includes the time frame of when the order was placed.

Refine search by inputting order #

A return can be searched for by STATUS:

- All
- Open
- Closed

Matching Returns (Click the Refresh button to see New Return Orders)

Return Order #	Reference Number	Print Date	Entry Date	Status	Description
	Warehouse 3	11-17-2022	11-16-2022	Fully Credited	
	Return	01-23-2023	01-23-2023	Completed	
	St	01-20-2023	01-20-2023	Fully Credited	
	St	01-17-2023	01-17-2023	Partially Credited	
	St	01-16-2023	01-16-2023	Completed	
		01-05-2023	01-03-2023	Fully Credited	

Select the drop down menu **“Parts Returns”**

Select **“Create New Return”**

Select the drop down menu **“Parts Returns”**

Select **“Create New Return”**

Matching Returns (Click the Refresh button to see New Return Orders)

Return Order #	Reference Number	Print Date	Entry Date	Status	Description
	Warehouse 3	11-17-2022	11-16-2022	Fully Credited	Obsolescence Return
	Return extra item received	01-23-2023	01-23-2023	Completed	Received in error



## Returns Management: Creating a new Return/Credit Request

- Select the main reason for the return at the top.
- Note: The Obsolescence Return option will only show up during certain times of the year if your dealership qualifies.

**Create Credit Order**

\* Return time frame is based on original invoice date.  
 \* For Marine Parts: 0-60 days = 10% restock fee, 61-90 days = 15%, 91+ days: see Obsolescence Return program.  
 \* For all other Parts: 0-60 days = No restocking fee, 61 - 90 days = 10% restocking fee, 91 - 120 days = 15% restocking fee.  
 \* All products must be returned in re-sellable condition with all dealer tags removed. Items not returned in original packaging or in re-sellable condition or an additional 20% repackaging fee will be applied. Yamalube products do not qualify for standard return.  
 \* Contact your Inside Sales Representative for more details @ 866-488-2350.

**Credit Request Information**

Parts Return Reason: 1. Standard Return – Item not needed  
 Credit Request Date: 07/30/2021  
 Warehouse: Yamaha Motor Corp. USA  
 (Customer Reference is for your own reference, Pls use tab key to continue to next field)  
 Customer Reference Number: \_\_\_\_\_  
 Customer Comments: \_\_\_\_\_

Order #	Part Number	Quantity	Description	Reason	Cost	Subtotal
		0		1. Standard Return – Item not needed	0.00	
		0		1. Standard Return – Item not needed	0.00	

1. Standard Return – Item not needed
2. Visible carrier damage – Damage
3. Visible carrier damage – Missing
4. Concealed damage – Box OK, Part is damaged
5. Item Missing – Received Less Than Packing List Quantity
6. Item Received, but Not Ordered – Bill My Parts Account
7. Item Received, but Not Ordered – I'm returning this item.
8. Incorrect Part Received – Item mislabeled
9. Sales Program Return
10. Obsolescence Return

- After you have selected the main reason for your return/credit request you can input Order #, Part Number, and Quantity.
- If you have an Excel spreadsheet you can copy and paste into this area.

**Item**

Add Line Delete Line Clear Line Validation

Order #	Part Number	Quantity	Description
		0	
		0	
		0	
		0	
		0	
		0	

**Search: Order #**

Search Criteria Hide Search Criteria ?

Sales Document [ ] [ + ] [ - ]  
 Material [ ] [ + ] [ - ]

[ Search ] [ Clear Entries ] [ Reset to Default ]

- If you do not know the order number you can click this icon to search for the order number.
- "Sales Document" = Order Number
- "Material" = Part Number

## Returns Management: Creating a new Return/Credit Request

- You can return multiple parts for multiple reasons.
- The reason code can be changed at the line level using the drop down box.

Item							
<input type="button" value="Add Line"/> <input type="button" value="Delete Line"/> <input type="button" value="Clear Line"/> <input type="button" value="Validation"/>							
Order #	Part Number	Quantity	Description	Reason	Cost	Subtotal	
		0		1. Standard Return – Item not needed	0.00		
		0		5. Item Missing – Received Less Than Packin...	0.00		
		0		4. Concealed damage – Box OK, Part is dam...	0.00		
		0		1. Standard Return – Item not needed	0.00		
		0		1. Standard Return – Item not needed	0.00		
		0		1. Standard Return – Item not needed	0.00		
		0		1. Standard Return – Item not needed	0.00		

- Click **“Submit”** when you are done.
- If you need more time to work on your return you can click **“Save”**.

### Create Credit Order

\* Return time frame is based on original invoice date.  
\* For Marine Parts: 0-60 days = 10% restock fee, 61-90 days = 15%, 91+ days: see Obsolescence Return program.  
\* For all other Parts: 0-60 days = No restocking fee, 61 - 90 days = 10% restocking fee., 91 - 120 days = 15% restocking fee.  
\* All products must be returned in re-sellable condition with all dealer tags removed. Items not returned in original packaging or in re-sellable condition will either be returned to your dealership or an additional 20% repackaging fee will be applied. Yamalube products do not qualify for standard return.  
\* Contact your Inside Sales Representative for more details @ 866-488-2350.

**Credit Request Information**

Parts Return Reason: 1. Standard Return – Item not needed

Credit Request Date: 07/30/2021

Warehouse: Yamaha Motor Corp. USA

(Customer Reference is for your own reference, Pls use tab key to continue to next field)

Customer Reference Number:

Customer Comments:

Item							
<input type="button" value="Add Line"/> <input type="button" value="Delete Line"/> <input type="button" value="Clear Line"/> <input type="button" value="Validation"/>							
Order #	Part Number	Quantity	Description	Reason	Cost	Subtotal	
		0		1. Standard Return – Item not needed	0.00		
		0		1. Standard Return – Item not needed	0.00		

*NOTE: Once return is submitted, you can send your parts back after printing your RMA form. See next page for RMA instructions.*

## Returns Management: Printing RMA

- ❑ Click **“REFRESH”** if you do not see your return.
- ❑ Click the blue **“Return Order #”** hyperlink to enter back into the order.

The screenshot shows the 'Returns' management interface. At the top, there is a 'CREATE NEW RETURN' button. Below it is the 'Returns Search Criteria' section, which includes a 'Return Order Number' field, a 'Date Range / Status' section with 'Type' (Creation Date), 'Start Date' (10/24/2022), 'Status' (All), and 'End Date' (01/24/2023) fields. There are 'SEARCH', 'REFRESH', and 'CLEAR' buttons. Below the search criteria is a table of 'Matching Returns' with columns for Return Order #, Reference Number, Print Date, Entry Date, Status, and Description. The first row is highlighted with a red box.

Return Order #	Reference Number	Print Date	Entry Date	Status	Description
<a href="#">[Redacted]</a>	Warehouse 3	11-17-2022	11-16-2022	Fully Credited	Obsolescence Return
<a href="#">[Redacted]</a>	Return extra item received	01-23-2023	01-23-2023	Completed	Received in error
<a href="#">[Redacted]</a>		01-20-2023	01-20-2023	Fully Credited	Part Return

## Returns Management: Editing or Printing RMA

- ❑ Click **“REFRESH”** if you do not see your return.
- ❑ Click the blue **“Return Order #”** hyperlink to enter back into the order.
- ❑ After the Return screen opens click **“Change”** or **“RMA Form”**

This screenshot is similar to the one above, showing the 'Returns' management interface. A callout box on the right side of the page highlights two buttons: 'Change' and 'RMA Form', both of which are highlighted with a red box.

## Returns Management: Printing RMA Forms

- Select RMA (Return Merchandise Authorization) icon to review and populate the RMA PDF for printing
- If there is no product to return you can skip this step.

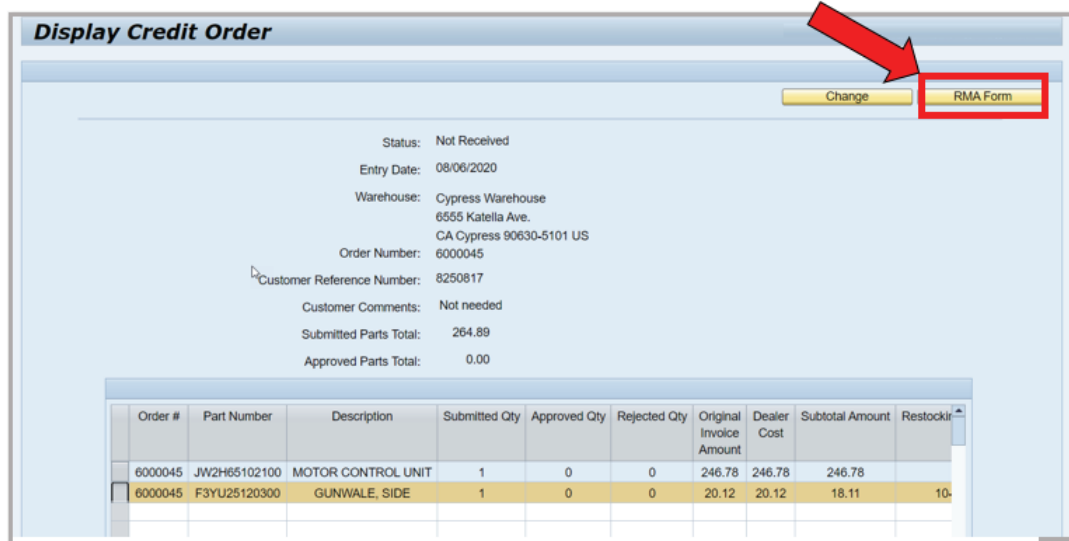

- Print the "Return Merchandise Authorization" label
- Ensure the printed RMA label is secured to the **OUTSIDE** of the parts package being returned to Yamaha.

**YAMAHA**  
 YAMAHA MOTOR CORPORATION, U.S.A.  
 Cut along this line and affix to shipping carton

Return Authorization No. 6000045

Delivery No. [Barcode]

Ship To (Warehouse)  
 Yamaha Motor Corp USA  
 ATTN: Returns Department  
 6555 Katella Ave.  
 Cypress CA 90630-5101

**Return Merchandise Authorization**

Return Authorization Number	Customer Reference Number	Reference
Return Reason 1. Standard Return - Item not needed		Return Code YP1
Date Approved 08/06/2020	RMA Expiration 09/05/2020	

Call Inside Sales Representative For More Details @ 866-488-2350

Item Number	Part Number	Description	Quantity	Net Price Each (\$)	Restock Fee (%)	Restock Fee (\$)	Extended Price (\$)
100	JW2H65102100	Motor Control Unit	1	246.78	0.00	0.00	246.78
200	F3YU25120300	Gunwale, Side	1	20.12	-10.00	-2.01	18.11
Total							\$264.89

Note: Actual return fees may increase based on additional repackaging fees that may be required after warehouse inspection.

## Returns Management: Checking Status

- Click **"REFRESH"** to see the most up to date status of your return/credit request.
- If the return status is **"Processing"** the Yamaha warehouse is waiting for your return to arrive.
- Click the Return Order # blue hyperlink to see more information.

**Returns**

[CREATE NEW RETURN](#)

**Returns Search Criteria**

Return Order Number:  Return Order #:

Date Range / Status: Type: Creation Date Start Date: 10/24/2022 Status: All End Date: 01/24/2023

[SEARCH](#) [REFRESH](#) [CLEAR](#)

**Matching Returns (Click the Refresh button to see New Return Orders)**

Return Order #	Reference Number	Print Date	Entry Date	Status	Description
<a href="#">[Link]</a>	Warehouse 3	11-17-2022	11-16-2022	Fully Credited	Obsolescence Return
<a href="#">[Link]</a>	Return extra item received	01-23-2023	01-23-2023	Completed	Received in error
<a href="#">[Link]</a>		01-20-2023	01-20-2023	Fully Credited	Part Return
<a href="#">[Link]</a>	Short shipment	01-17-2023	01-17-2023	Partially Credited	Short shipment
<a href="#">[Link]</a>	Short shipment	01-16-2023	01-16-2023	Completed	Short shipment
<a href="#">[Link]</a>		01-05-2023	01-03-2023	Fully Credited	Part Return

### Display Credit Order

- Yamaha has not received your return.
- Print RMA Form and return item(s).

[Change](#) [RMA Form](#)

Status: **Not Received**

Entry Date: 08/02/2021

Warehouse: Yamaha Motor Corp. USA  
8555 Katella Ave  
CA Cypress 90630-5101 US

Order Number: 6008033

Customer Reference Number:

Customer Comments:

Submitted Parts Total: 282.60

Approved Parts Total: 0.00

Order #	Part Number	Description	Submitted Qty	Approved Qty	Rejected Qty	Original Invoice Amount	Dealer Cost	Subtotal Amount	Restocking Fee	Repackaging Fee	Ap
8755596	1XDE47100200	Muffler Assy 1	1	0	0	273.08	273.08	273.08			
8768773	4S1G38580000	BALL	4	0	0	9.52	9.52	9.52			

## Quality Assurance Claims

- ❑ Quality assurance claims can be filed for up to (1) year from date of retail purchase for pleasure use and 90 days for commercial use.
- ❑ In YMBS, under the Parts tab, **Warranty > QA claims**, you will create our QA Claim.
- ❑ In your Problem and Defect descriptions for your claim be as thorough as possible. Don't forget to Save and Submit when complete.

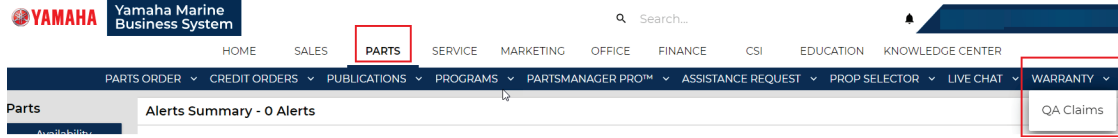

**QA Warranty Claim**

+ NEW SEARCH CLAIMS

---

**Warranty Claims**

**\*QA Code** |

- QA101-0999999 General Part
- QA181-0999999 Outboard System**

- ❑ Select: QA181-0999999 Outboard and create your claim.
- ❑ If you are filing a claim for a missing component from a kit you will file the claim for the missing component and for the Causal part you will input the kit part number. For example, if you received the following kit:
  - MAREXHKT0400 EXH KIT F200-250 04 UP and it was missing a component such as the 69J41135A000 GASKET, EXHAUST MANIFOLD you would file the claim for the missing 69J41135A000 GASKET and your Causal Part would be MAREXHKT0400 EXH KIT F200-250 04.

Claim #:

**Failed Parts**

Your failed part would be the missing component

Part ID:  Qty:

Part ID	Description

**Causal Part Information**

The Causal part is the kit part number

\*Causal Part:

## MRP Parts Frequency Report

This 12-month frequency report is an essential tool when planning your parts business. The report shows a full 12-months of the parts your dealership has ordered broken down by category. Placing a monthly parts order for items you know you will sell can make a difference in your bottom line.

- From the Parts Tab, select "**Publications**", "**Reports**", then select MRP Parts Frequency Report.
- An Excel file will then download to your computer with the last 12 months of your invoiced items broken down by category.

The screenshot shows a navigation menu with the following structure:

- PARTS** (selected)
- PUBLICATIONS** (dropdown menu)
  - Forms
  - Parts Manager Pro Information
  - Reports** (dropdown menu)
    - MRP Parts Frequency Report (highlighted with a red arrow)
    - MRP Dealer Call Report
    - Top Parts by YMA
    - MRP Rebate Accumulation Report
  - Other Documents
  - Price File Download

Part Group	Part Number	Part Name	Mar	Apr	May	Jun	Jul	Aug
O/M - DIGITAL GAUGE	6Y58350TD000	TACHOMETER ASSY	2	0	0	0	0	0
O/M - DIGITAL GAUGE Sub-Total			2	0	0	0	0	0
O/M - CABLES	MARCABLE11SC	PREMIER II CABLE 11 FOOT	0	0	2	0	0	0
	MARCABLE21SC	PREMIER II CABLE 21 FOOT	0	0	0	0	0	0
	MARCABLE20SC	PREMIER II CABLE 20 FOOT	0	0	0	0	0	0
	MARCABLE12SC	PREMIER II CABLE 12 FOOT	0	0	2	0	0	0
O/M - CABLES Sub-Total			0	0	4	0	0	0
O/M - COMMAND LINK	6Y8825212100	3FT PIGTAIL BUS	0	0	0	0	0	0
	6Y8825534100	30FT MAIN BUS	0	0	0	0	0	0
	6Y88350T2100	TACHOMETER, RD	0	0	6	0	0	0

## MRP Top Parts by YMA (Yamaha Market Area)

The Top Parts by YMA is a useful tool that shows a rolling 12-month total for parts sold in the dealer's YMA.

- At the top of the report the YMA and the number of dealers in the marketing area are listed.
- From the Parts Tab, select "**Publications**", "**Reports**", then select Top Parts by YMA.

The screenshot shows a navigation menu with the following structure:

- PARTS** (selected)
- PUBLICATIONS** (dropdown menu)
  - Forms
  - Parts Manager Pro Information
  - Reports** (dropdown menu)
    - MRP Parts Frequency Report
    - MRP Dealer Call Report
    - Top Parts by YMA** (highlighted with a red arrow)
    - MRP Rebate Accumulation Report
  - Other Documents
  - Price File Download

## MRP Top Parts by YMA (Yamaha Market Area)

- ❑ In the example below, the YMA is Atlanta, GA and the best-selling outboard parts are the 20 Foot Wire Harness and Panel, Main Switch.
- ❑ Also, from the report we can see the YMA sold 30 Tachometer Assemblies. If a dealer sold 10 of the same part during the same period, they would have 33% market share on that part. That is a very good percentage of sales.

### 524 - ATLANTA GA

#### MRP RIGGING

Part Number	Part Number Description	Qty
6888258A6000	WIRE HARNESS 20FT	41
704825701300	PANEL, MAIN SWITCH A	41
6Y58350TD000	TACHOMETER ASSY	30
703482072300	703 SIDE/MNT ES W/TR	30

- ❑ From the Parts Tab, select "**Publications**", and "**Forms**".
- ❑ Parts Manager Pro™ Information Installation Guide, the Price File Download allows dealers to download an updated pricing file for Parts Manager Pro™ or their business system.
- ❑ MRP order form is a PDF file that can be filled out and faxed to the MRP sales team. Please include your dealer number, dealer contact, Purchase Order number, Sales Program and preferred shipment method.

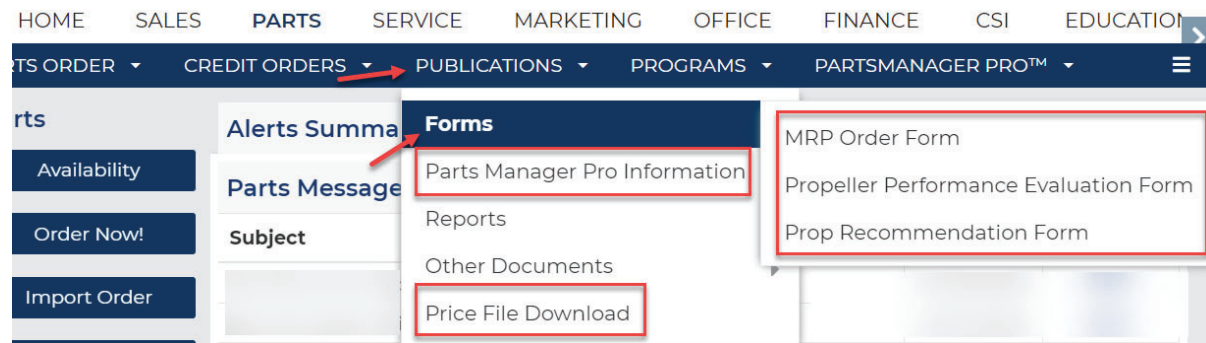

## MRP Programs

- ❑ The "**Programs Menu**" offers a dealer quick access to the year round or long-term sales programs offered by the MRP Sales Team.
- ❑ Note: Special or seasonal sales programs will not appear in this menu. Remember to routinely view your **Parts Message Screen** for seasonal program offerings.
- ❑ You can click on the program name and a PDF of the program will pop up allowing the dealer to print or view the document.

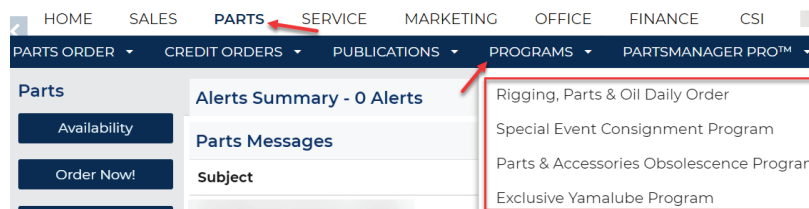



## Knowledge Center

- ❑ You will be able to access each section of the Marine Rigging and Parts Catalog in the Knowledge Center.
- ❑ In YMBS, go to the “**Knowledge Center**”, click “**Search Knowledge Center**” you will see the left side of the screen with options to choose from. Click the  next to the “**Rigging and Parts Catalog**” to expand - then click “**MRP Catalog**”. Each section of the catalog will be available for you to view or print as a PDF file. Also, on the left side you will see many different options to choose from.
- ❑ Within the Knowledge Center you will have access to technical bulletins, owner’s and service manuals, service videos, safety data sheets and much more. The “**Search by Keyword**” option is an excellent tool to find just what you need.

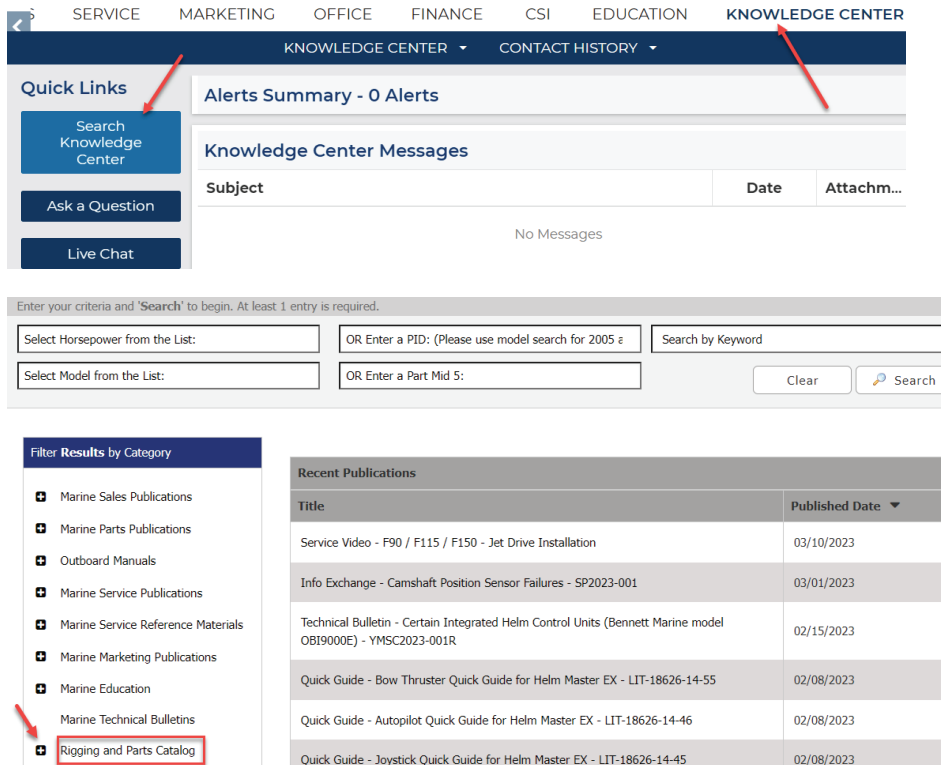

The screenshot shows the Knowledge Center interface with the following elements:

- Navigation tabs: SERVICE, MARKETING, OFFICE, FINANCE, CSI, EDUCATION, KNOWLEDGE CENTER.
- Sub-navigation: KNOWLEDGE CENTER, CONTACT HISTORY.
- Quick Links: Search Knowledge Center, Ask a Question, Live Chat.
- Alerts Summary: 0 Alerts.
- Knowledge Center Messages table with columns: Subject, Date, Attachm... (No Messages).
- Search filters: Select Horsepower from the List, OR Enter a PID: (Please use model search for 2005 a), Search by Keyword, Select Model from the List, OR Enter a Part Mid 5, Clear, Search.
- Filter Results by Category: Marine Sales Publications, Marine Parts Publications, Outboard Manuals, Marine Service Publications, Marine Service Reference Materials, Marine Marketing Publications, Marine Education, Marine Technical Bulletins, Rigging and Parts Catalog (highlighted).
- Recent Publications table:

Title	Published Date
Service Video - F90 / F115 / F150 - Jet Drive Installation	03/10/2023
Info Exchange - Camshaft Position Sensor Failures - SP2023-001	03/01/2023
Technical Bulletin - Certain Integrated Helm Control Units (Bennett Marine model OBI9000E) - YMSC2023-001R	02/15/2023
Quick Guide - Bow Thruster Quick Guide for Helm Master EX - LIT-18626-14-55	02/08/2023
Quick Guide - Autopilot Quick Guide for Helm Master EX - LIT-18626-14-46	02/08/2023
Quick Guide - Joystick Quick Guide for Helm Master EX - LIT-18626-14-45	02/08/2023

- ▣ Rigging and Parts Catalog
  - MRP Catalog 
  - Rigging Guides
  - Rigging Information

## PartsManager Pro™

- ❑ Under the Parts tab, click the “PartsManager Pro™” (PMP) menu or the quick link. PMP will load in a separate window. It is important to make sure any pop-up blockers are turned off. Once the PMP Online window has opened, you are ready to use the software.

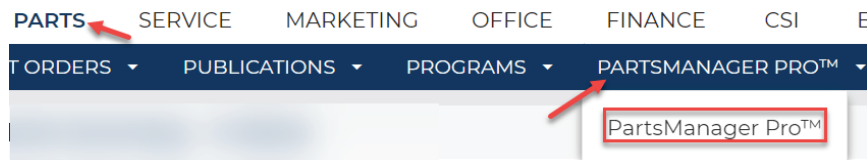

- ❑ Find by Product is one of the quickest ways to navigate PMP. The most common method is using the model number.
- ❑ Once you click enter a list of models meeting your search criteria will populate on the left side of the screen. Click the model that matches your production date. The list of parts diagrams will load for your model.

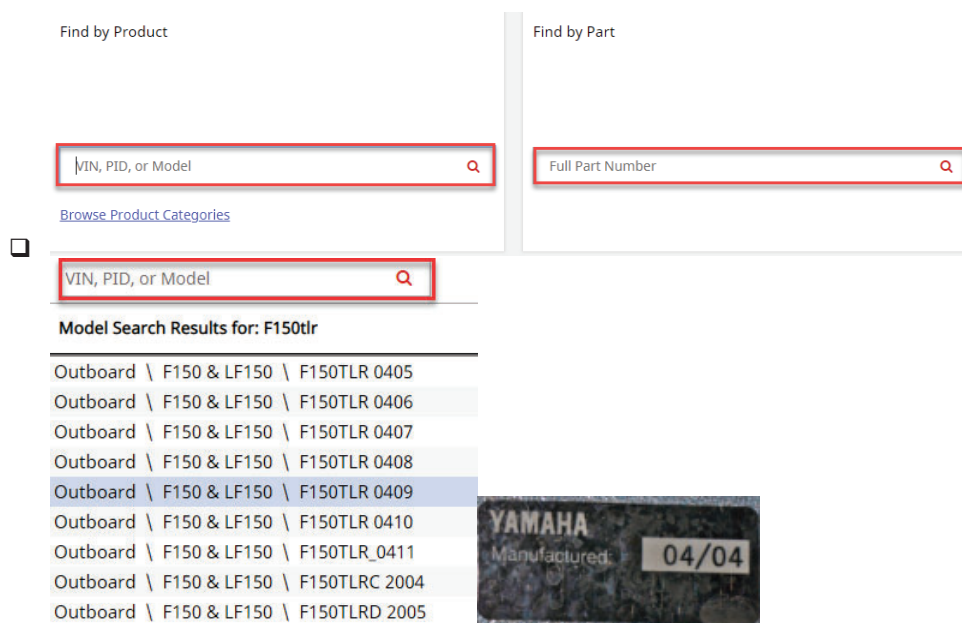

Note: Select the model with the closest earlier production date. For example, if the actual production date was 08/2008, the correct model would be with the production date of 0408 in screen shot above. Production dates can be located on the engine clamp bracket.

- ❑ You can also search by Primary ID (PID). The most accurate way to find part for an outboard engine is to search by PID. The PID can be found on the clamp bracket of the engine as well.

Once the parts diagrams load after selecting the model or PID you entered, there is a wealth of information available to the user. There are several interactive icons on the screen as well as multiple columns of information listed with the drawing.

## PartsManager Pro™

1. Displays the engine and diagram currently being viewed.
2. Navigates to the previous or next drawing in the engine list.
3. Allows the addition of Notes to the system. Notes can be saved for future reference.
4. Selects part and adds to a pick list. Pick lists can be exported to an order or printed as an estimate. If you need to change the quantity, do so on the pick list.
5. The feedback button is used to report errors or provide feedback about PMP.
6. Adjust the size of the drawing within the window. Allows you to zoom in, out or full screen.
7. Prints the Illustration Only, Parts List Only or prints both Illustration and Parts list.
8. Indicates a note exists for the part, click the icon to view the note.
9. Identifies a supersession took place for this part. Click the icon to view the details.
10. Click on the part number hyperlink and more information on the part will populate.
11. Click on the Callout number and this will highlight the part in the drawing.
12. The number listed under the quantity is the quantity of the part used on the engine.
13. Remarks listed display important information about the fitment of the part.

### Additional Notes:

- Viewing part supersessions –
  - Part numbers can change from time to time. When a part supersedes, PMP will display two blue arrow icons informing you of a change in the part number.
  - To view the part number change information, click on the blue arrow icon.
- Viewing system notes –
  - Part notes can be added by Yamaha or a dealership. To view a note listed with a part, click on the note icon next to the part.
- Part number hyperlink –
  - By clicking on the part number hyperlink, the Part Overview will appear. This will show dealer and retail cost.
  - By clicking on Substitutions, the history of the part number will populate.
  - By clicking on Part Information, the dimensions and weights of the package will pop up.

Pricing	
Dealer	Retail
\$16.30	\$26.30

**NOTE: The most accurate pricing for dealer cost and MSRP will always be obtained through YMBS. Updating your PMP price file regularly will assist you in receiving the most accurate dealer cost and MSRP.**

## Helm Master® EX Rigging Builder

- ❑ Yamaha now offers an excellent tool in YMBS to help you determine the components needed to build your complete Helm Master boat control system.
- ❑ Visit the Service tab in YMBS and select from the Quick Links on the left: Helm Master® EX Rigging Builder.
- ❑ You can now begin by either selecting Full Maneuverability Kits or Individual Components.
- ❑ From your selection, you can now begin selecting for your application.
- ❑ User Guide on next page.

The screenshot displays the Yamaha Marine Business System (YMBS) interface. At the top left is the Yamaha logo and the text "Yamaha Marine Business System". A search bar is located to the right of the logo. Below the logo is a navigation menu with the following items: HOME, SALES, PARTS, SERVICE (highlighted with a red arrow), MARKETING, OFFICE, FINANCE, CSI, and E. Below the navigation menu is a secondary menu with items: WARRANTY CLAIMS / AUTHORIZATIONS, TOOLS, SERVICE REFERENCE GUIDE (highlighted with a red arrow), YDIS, and MAINTENANCE TR. On the left side, there is a "Service" sidebar with several buttons: Unit Status, New Claims/Authoriz..., Flat Rates, Labor Rate Change, Live Chat, Knowledge Center, Helm Master EX Rigging Builder (highlighted with a red arrow), Service Data Portal, and PartsManager Pro. The main content area shows "Alerts Summary - 1 Alerts" with a link to "Maintenance Tracking - Your Customers have Maintenance Services due." Below this is a "Parts Messages" section with a "Subject" header and several bullet points:
 

- \* On Board Magazine - April 2023
- \* New Service Video Added to YMBS Knowledge Center: Service Video - Claims and Authorizations Overview for YMBS
- \* New Service Video Added to YMBS Knowledge Center: Service Video - How to Make a QA Claim in YMBS
- \* New Service Video Added to YMBS Knowledge Center: Service Video - F90 / F115 / F150 - Jet Drive Installation
- \* Announcing 2022 Marine Service PRO Dealer Achievements

 At the bottom of the main content area, there are two columns of information: "Live Chat Hours of Operation" (Monday-Friday, 9:00am-5pm EST, Closed Sat-Sun) and "Service Hours of Operation" (Marine M-Friday, 8:30am-5pm EST, Closed Sat-Sun).

## Helm Master® EX Rigging Builder

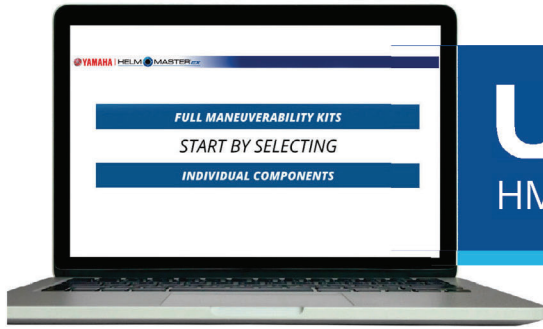

# User Guide

## HMEX Rigging Guide Selection Tool

### How to Access the Rigging Guide

<b>Step 1:</b> Go to YMBS	<b>Step 2:</b> Go to the Service Tab-Quick Links	<b>Step 3:</b> Select Helm Master® EX Rigging Builder
------------------------------	---	--

### Getting Started on the Rigging Guide

FULL MANEUVERABILITY KITS

START BY SELECTING

INDIVIDUAL COMPONENTS

Begin by choosing either **Full Maneuverability Kits** or **Individual Components**.

EXB	EKS	SINGLE	HM-EX	RETURN	USER
SINGLE Engine	CLS Control	DES Installed			
TWIN Engine	MFDI-1 Control	DES Installed			
TRIPLE Engine	MFDI-2 Control				
QUAD Engine	CL7 Control				

SELECT FROM EACH AVAILABLE OPTION

**Click each available option.** Once the entire navigation bar has been selected, the rigging guide will populate. Wait for it to load.

Single Engine Maneuverability Kit (Interlocked DSC)	MAH-HML11-01-00	1
Single Main Station	INCLUDED IN KIT ABOVE	1
Single Main Station Smart Key	INCLUDED IN KIT ABOVE	1
Power Switch	INCLUDED IN KIT ABOVE	1
DSC Hardware	INCLUDED IN KIT ABOVE	1
Engine Start/Off Switch	INCLUDED IN KIT ABOVE	1
DSC Receiver	INCLUDED IN KIT ABOVE	1
DSC Digital Bus	INCLUDED IN KIT ABOVE	1
Helm Unit Assembly	INCLUDED IN KIT ABOVE	1
T18 Helm Unit	INCLUDED IN KIT ABOVE	1
Instruction Manual, T18 Helm	INCLUDED IN KIT ABOVE	1
Blue Control Unit - A/B/Single	INCLUDED IN KIT ABOVE	1
Blue Control Unit Harness	INCLUDED IN KIT ABOVE	1
Joystick Control Assembly	INCLUDED IN KIT ABOVE	1
Helm Master Prop Light (L.E.D. Assembly)	INCLUDED IN KIT ABOVE	2
GPS Link	INCLUDED IN KIT ABOVE	1
Autopilot Control Panel Assembly	INCLUDED IN KIT ABOVE	1
Heading Sensor Unit	INCLUDED IN KIT ABOVE	1
Wire Load	INCLUDED IN KIT ABOVE	2
Dev Line Hub Assembly	INCLUDED IN KIT ABOVE	1
DCM (Digital Communication Kit)	INCLUDED IN KIT ABOVE	1

The **left side** of the screen will display the rigging components.

The **right side** of the screen will display the part names, part numbers, and quantity.

## Helm Master® EX Rigging Builder

### Navigation Elements

TWIN ENGINE 6X9 TOP MOUNT MFD-1 Down Display STD SWITCH DES INTEGRATED SINGLE STATION HM-EX AUTOMOUNT RETURN TO START USER GUIDE SHOW ALL LOCATIONS SAVE PARTS ORDER SHOW ALL PART NUMBERS

**SHOW**  
ALL LOCATIONS

Click **Show All Locations** at the top of the screen to display the part locations on the diagram.

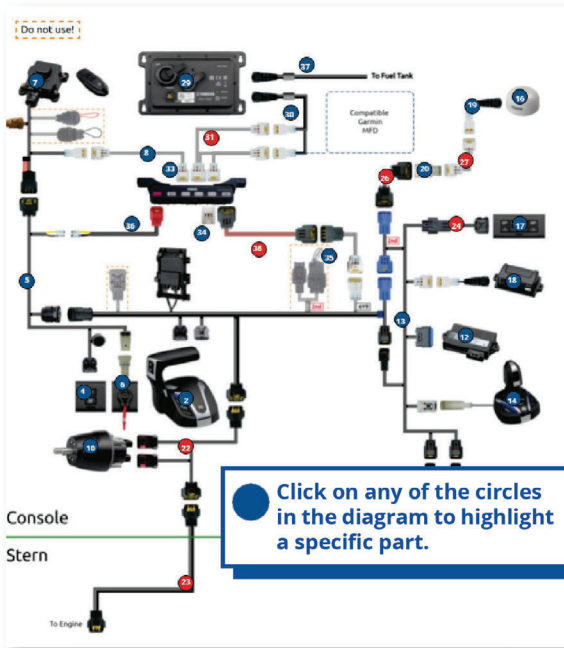

**Red circles indicate user needs to choose rigging options.**

1	OPTIONAL YCOP		1	+	-
2	Pigtail Harness for YCOP		1	+	-

Using the drop-down menus, select the options on the right side of the screen to retrieve the part numbers for the items in red. Once an item has been selected, the part indication circle will turn blue.

**SHOW**  
ALL PART NUMBERS

Click **Show All Part Numbers** at the top of the screen to display the part numbers of items included in the kits.

6X9-49207-00-00	1	+	-
6X6-762B0-00-00	1	+	-
6X6-82570-51-00	1		
6X6-82570-60-00	1		
6X6-82570-C0-00	1	+	-
6X9-762D0-11-00	1	+	-
6Y8-82521-01-00	1	+	-
6YM-8A2D0-10-00	1	+	-
MAR-CL0D1-KT-00	1	+	-

Using the **+** and **-** buttons, adjust the quantity of parts needed for each line item. Adjusting the quantity adjusts the parts order, and not the required quantity of the items in the kit.

**SAVE**  
PARTS ORDER

Click **Save Parts Order** at the top of the screen to save the order as a .CSV file that opens in Microsoft Excel.

**RETURN**  
TO START

Click **Return to Start** at the top of the screen to start over.



## Marine Rigging and Parts

Please feel free to reach out to the Marine Rigging and Parts team at (800) 366-1972 with questions or the YMBS (Yamaha Marine Business System) support team at (800) 854-4876 with any technical issues.

If you have additional comments or concerns, send us an email at [marinepartsales@yamaha-motor.com](mailto:marinepartsales@yamaha-motor.com). We value your business.







<b>Description</b>	<b>Page</b>
<b>Single Engine</b>	
Single Engine with Mechanical Side Mount Controls	2-1
Single Engine with Mechanical Flush Mount Controls	2-5
Single Engine with Binnacle Controls	2-8
Helm Master® EX with Flush Mount	2-17
Single Engine Single Station Level 2 EKS (KEY SWITCH) - Helm Master® EX	2-18
Single Engine Single Station Level 2 6X6 (KEY SWITCH) - Helm Master® EX	2-19
Single Engine Maneuverability Kit for Built in Electric Steering - Helm Master® EX	2-20
Single Engine Second Station Level 4 - Helm Master® EX	2-21
<b>Twin Engines</b>	
Twin Engine with Mechanical Binnacle Controls	2-22
Twin Engine Single Station Level 2 EKS (KEY SWITCH) - Helm Master® EX	2-25
Twin Engine Single Station Level 2 6X6 (KEY SWITCH) - Helm Master® EX	2-26
Twin Engine Maneuverability Kit for Built in Electric Steering - Helm Master® EX	2-27
Twin Engine Second Station Level 4 - Helm Master® EX	2-28
<b>Triple Engines</b>	
Triple Engine Single Station Level 2 EKS (KEY SWITCH) - Helm Master® EX	2-29
Triple Engine Single Station Level 2 6X6 (KEY SWITCH) - Helm Master® EX	2-30
Triple Engine Maneuverability Kit for Built in Electric Steering - Helm Master® EX	2-31
Triple Engine Second Station Level 4 - Helm Master® EX	2-32
<b>Quad Engines</b>	
Quad Engine Single Station Level 2 EKS (KEY SWITCH) - Helm Master® EX	2-33
Quad Engine Single Station Level 2 6X6 (KEY SWITCH) - Helm Master® EX	2-34
Quad Engine Maneuverability Kit for Built in Electric Steering - Helm Master® EX	2-35
Quad Engine Second Station Level 4 - Helm Master® EX	2-36
<b>Command Link® and Command Link Plus® Accessories</b>	
Adding a Multi-Hub	2-37
Adding an AGI (Analog Gauge Interface)	2-39
Adding a Multisensor	2-40
<b>Y-COP® Installations</b>	
Y-COP® with Single Engine	2-41
Y-COP® with Twin/Triple Engines with Command Link® Switches	2-42
Y-COP® with Twin/Triple Engines with Command Link Plus® Main Switches	2-43
Adding in a Bow Thruster with Helm Master® EX	2-44

# Rigging Estimate Guide

## Single Engine with Mechanical Side Mount Controls - Analog Gauges

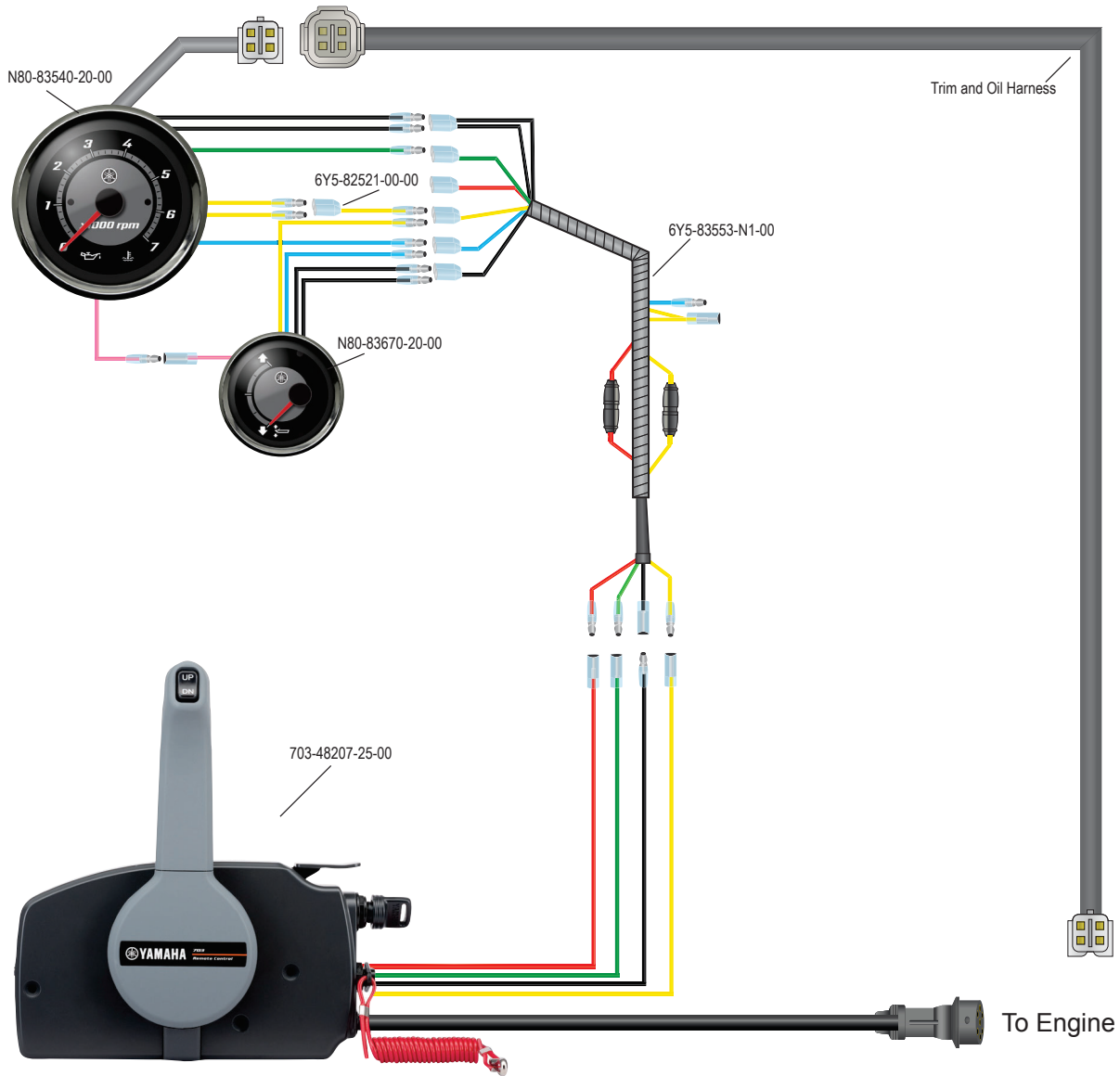

### Parts order list for basic installation:

Quantity	Description	Part Number
1	703 Side Mount Control with 10 Pin Harness	703-48207-25-00
1	Analog Tachometer	N80-83540-20-00
1	Analog Trim Meter	N80-83670-20-00
1	Dual Fuse Harness	6Y5-83553-N1-00
1	Yellow Wire Extension	6Y5-82521-00-00
1	2005~ Trim and Oil Harness	See List <sup>1</sup>

<sup>1</sup> 2005~ Trim and Oil Harness	
16.4 ft.	6Y5-83653-00-00
19.7 ft.	6Y5-83653-10-00
23 ft.	6Y5-83653-20-00
26.3 ft.	6Y5-83653-30-00
30 ft.	6Y5-83653-40-00
35 ft.	6Y5-83653-50-00

## Single Engine with Mechanical Side Mount Controls - Analog Gauges

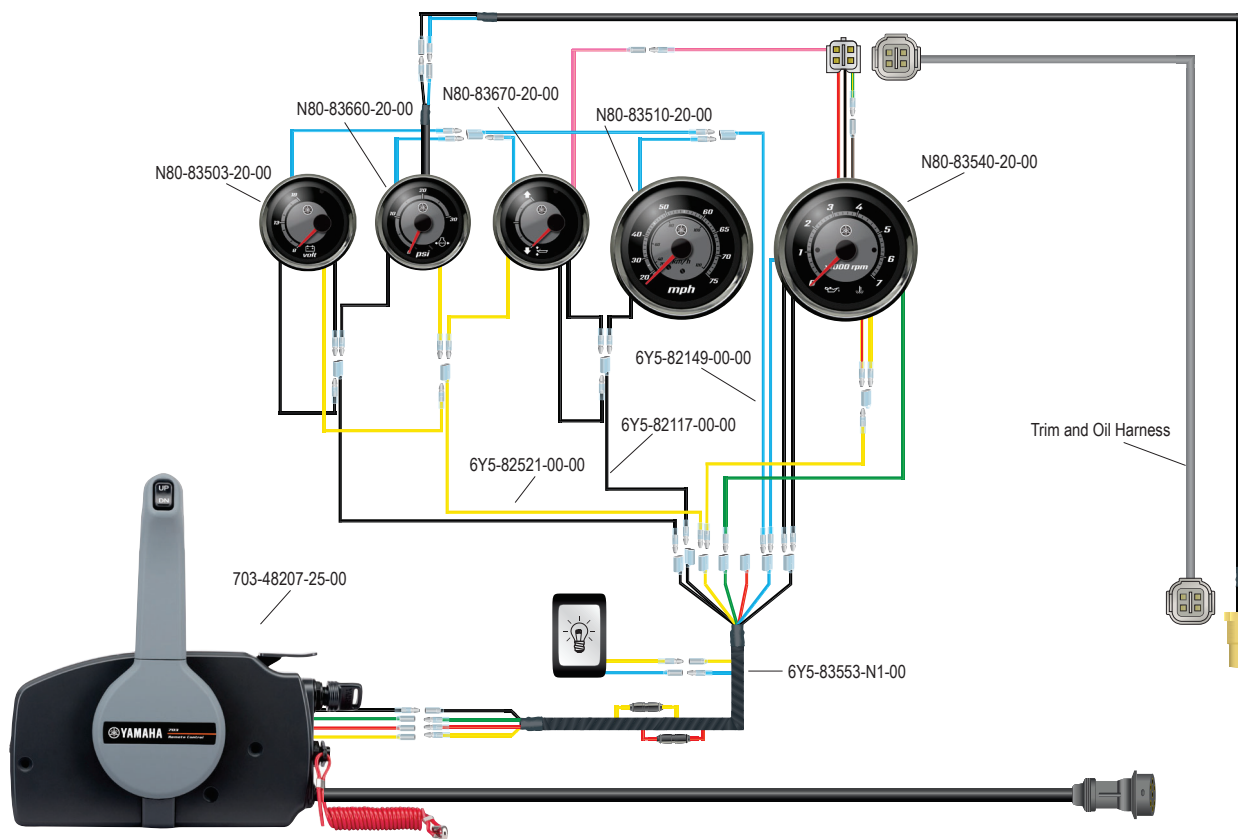

### Parts order list for basic installation:

Quantity	Description	Part Number
1	703 Side Mount Control with 10 Pin Harness	703-48207-25-00
1	Analog Tachometer	N80-83540-20-00
1	Analog Speedometer	N80-83510-20-00
1	Analog Trim Meter	N80-83670-20-00
1	Analog Water Temp Gauge	N80-83660-20-00
1	Analog Volt Meter	N80-83503-20-00
1	Water Pressure Sender	688-83667-01-00
1	Dual Fuse Harness	6Y5-83553-N1-00
2	Yellow Wire Extension	6Y5-82521-00-00
2	Blue Wire Extension	6Y5-82149-00-00
2	Black Wire Extension	6Y5-82117-00-00
1	2005~ Trim and Oil Harness	See List <sup>1</sup>

<sup>1</sup> 2005~ Trim and Oil Harness	
16.4 ft.	6Y5-83653-00-00
19.7 ft.	6Y5-83653-10-00
23 ft.	6Y5-83653-20-00
26.3 ft.	6Y5-83653-30-00
30 ft.	6Y5-83653-40-00
35 ft.	6Y5-83653-50-00

# Rigging Estimate Guide

## Single Engine with Mechanical Side Mount Controls - Multifunction Gauges

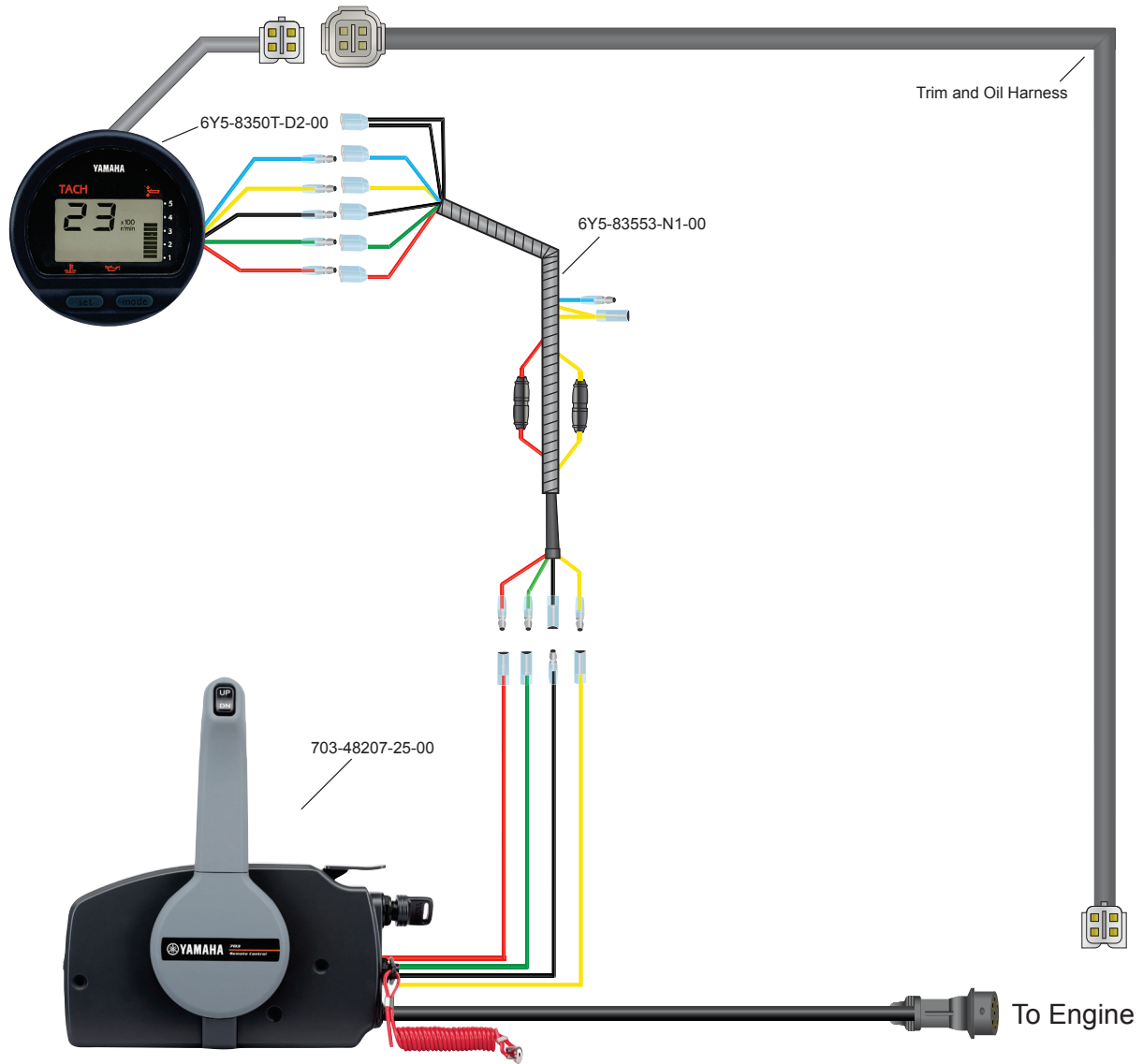

### Parts order list for basic installation:

Quantity	Description	Part Number
1	703 Side Mount Control with 10 Pin Harness	703-48207-25-00
1	Multifunction Tachometer Kit	6Y5-8350T-D2-00
1	Dual Fuse Harness	6Y5-83553-N1-00
1	Trim and Oil Harness	See List <sup>1</sup>

<sup>1</sup> 2005~ Trim and Oil Harness	
16.4 ft.	6Y5-83653-00-00
19.7 ft.	6Y5-83653-10-00
23 ft.	6Y5-83653-20-00
26.3 ft.	6Y5-83653-30-00
30 ft.	6Y5-83653-40-00
35 ft.	6Y5-83653-50-00

## Single Engine with Mechanical Side Mount Controls - Command Link®

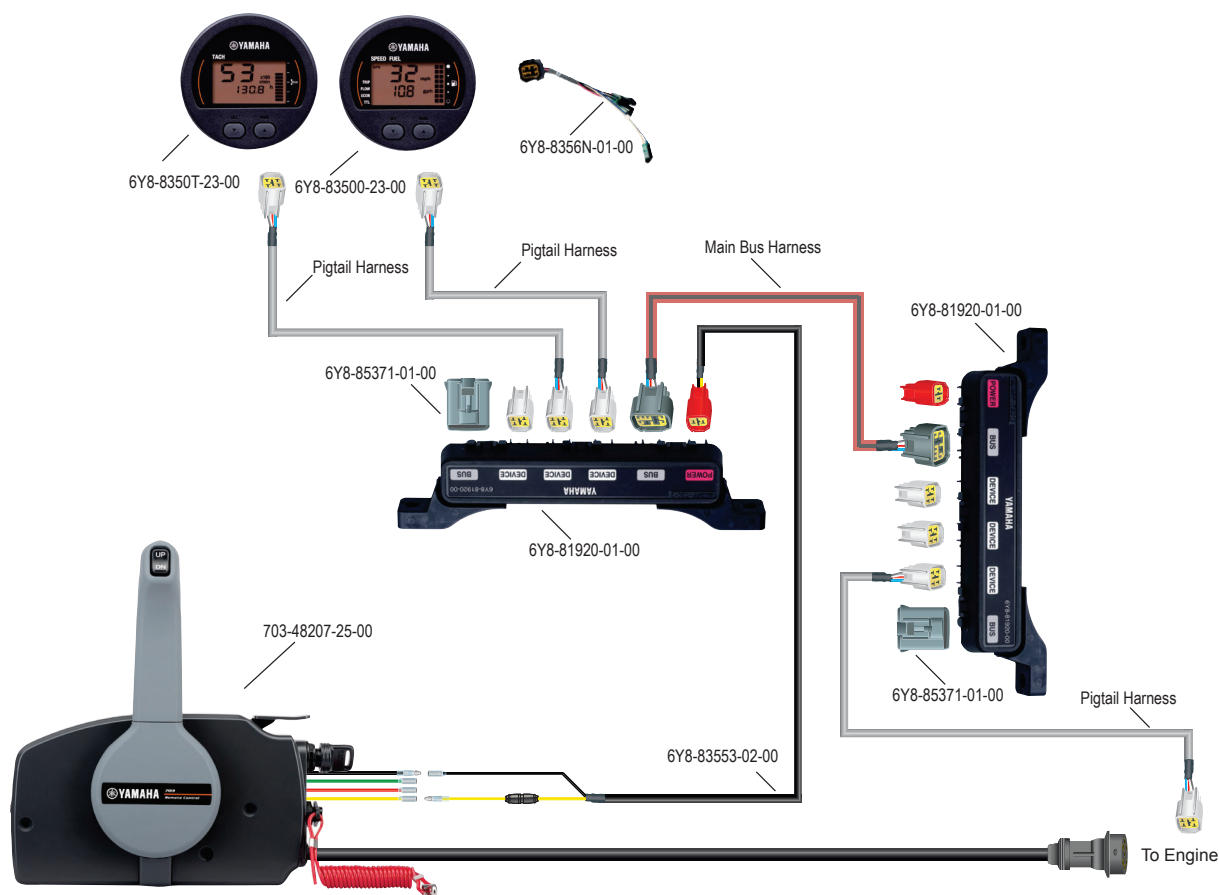

### Parts order list for basic installation:

Quantity	Description	Part Number
1	703 Side Mount Control with 10 Pin Harness	703-48207-25-00
1	Command Link Tachometer	6Y8-8350T-23-00
1	Command Link Speed / Fuel Gauge	6Y8-83500-23-00
2	Multi-Hub Assembly	6Y8-81920-01-00
1	Power Lead, 8 ft.	6Y8-83553-02-00
1	Cap, 2 Pin	6Y8-82582-01-00
3	Cap, 4 Pin	6Y8-82582-11-00
1	Speed Sensor Kit	60V-8A4L1-1C-00
1	Fuel Sender and GPS Wire Lead	6Y8-8356N-01-00
1	Pigtail Harness, Engine to Rear Hub, 12 ft.	6Y8-82521-51-00
2	Pigtail Harness, Hub to Gauge	See List <sup>1</sup>
1	Main Bus Hub, Rear Hub to Front Hub	See List <sup>2</sup>

<sup>1</sup> Pigtail Harnesses	
1 ft.	6Y8-82521-01-00
2 ft.	6Y8-82521-11-00
3 ft.	6Y8-82521-21-00
6 ft.	6Y8-82521-31-00
9 ft.	6Y8-82521-41-00
12 ft.	6Y8-82521-51-00
<sup>2</sup> Main Bus Harnesses	
1 ft.	6Y8-82553-01-00
10 ft.	6Y8-82553-50-00
15 ft.	6Y8-82553-11-00
20 ft.	6Y8-82553-21-00
25 ft.	6Y8-82553-31-00
30 ft.	6Y8-82553-41-00

# Rigging Estimate Guide

## Single Engine with Mechanical Flush Mount Controls - Multifunction Gauges

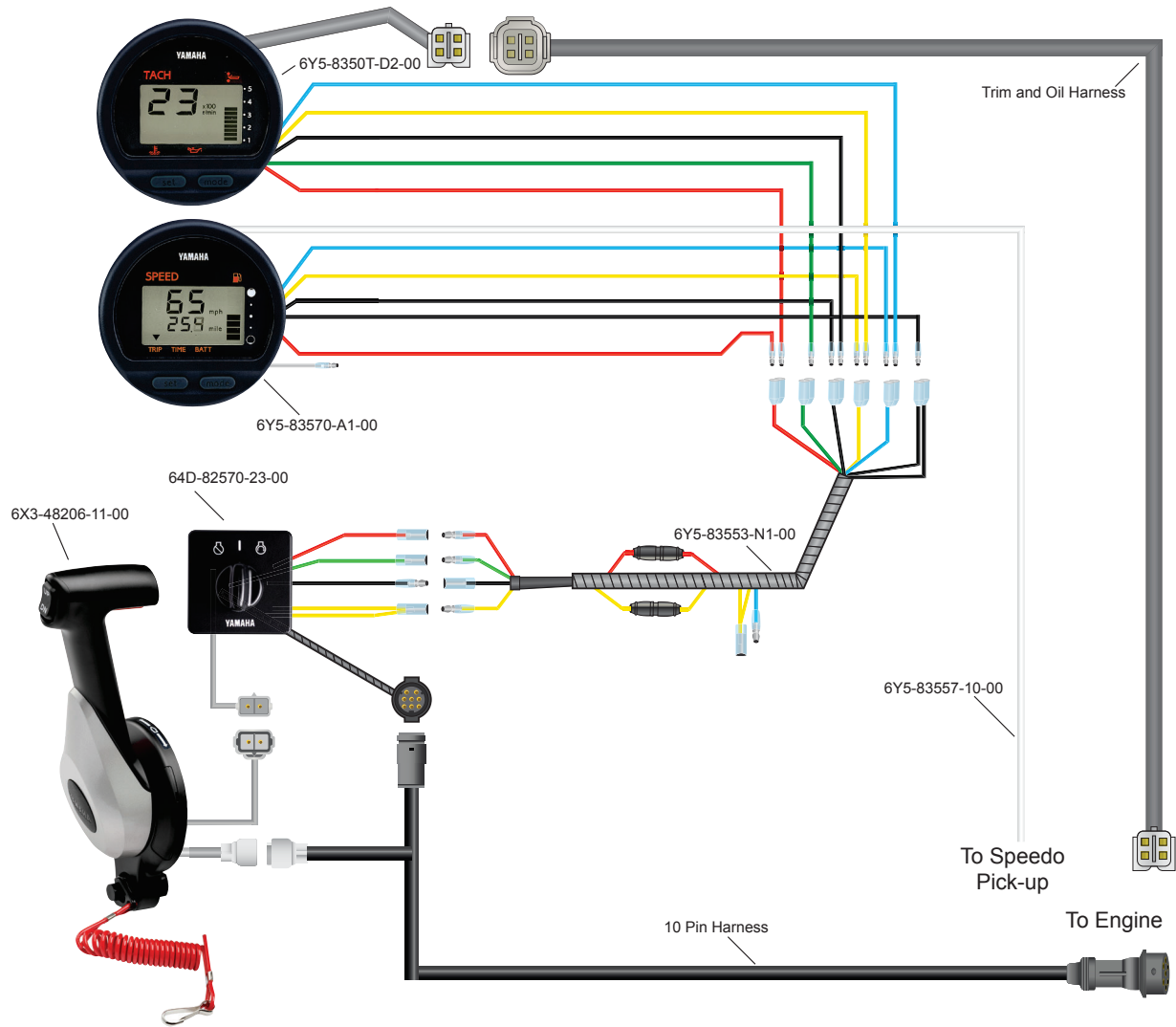

### Parts order list for basic installation:

Quantity	Description	Part Number
1	6x3 Premium Flush Mount Control Box	6X3-48206-11-00
1	Single Engine Key Switch	64D-82570-23-00
1	Multifunction Tachometer	6Y5-8350T-D2-00
1	Multifunction Speedometer	6Y5-83570-A1-00
1	Speedometer Tube, 8.0 m	6Y5-83557-10-00
2	Clamp	90465-10098-00
10	Clamp	90465-13M39-00
1	Dual Fuse Harness	6Y5-83553-N1-00
1	10-Pin Main Harness	See List <sup>1</sup>
1	Trim and Oil Harness (2005~)	See List <sup>2</sup>

<sup>1</sup> 10-Pin Harnesses	
16 ft.	688-8258A-50-00
20 ft.	688-8258A-60-00
23 ft.	688-8258A-70-00
26 ft.	6K1-8258A-41-00
31.2 ft.	61B-8258A-02-00
<sup>2</sup> 2005~ Trim and Oil Harness	
16.4 ft.	6Y5-83653-00-00
19.7 ft.	6Y5-83653-10-00
23 ft.	6Y5-83653-20-00
26.3 ft.	6Y5-83653-30-00
30 ft.	6Y5-83653-40-00
35 ft.	6Y5-83653-50-00

## Single Engine with Mechanical Flush Mount Controls - Multifunction Gauges

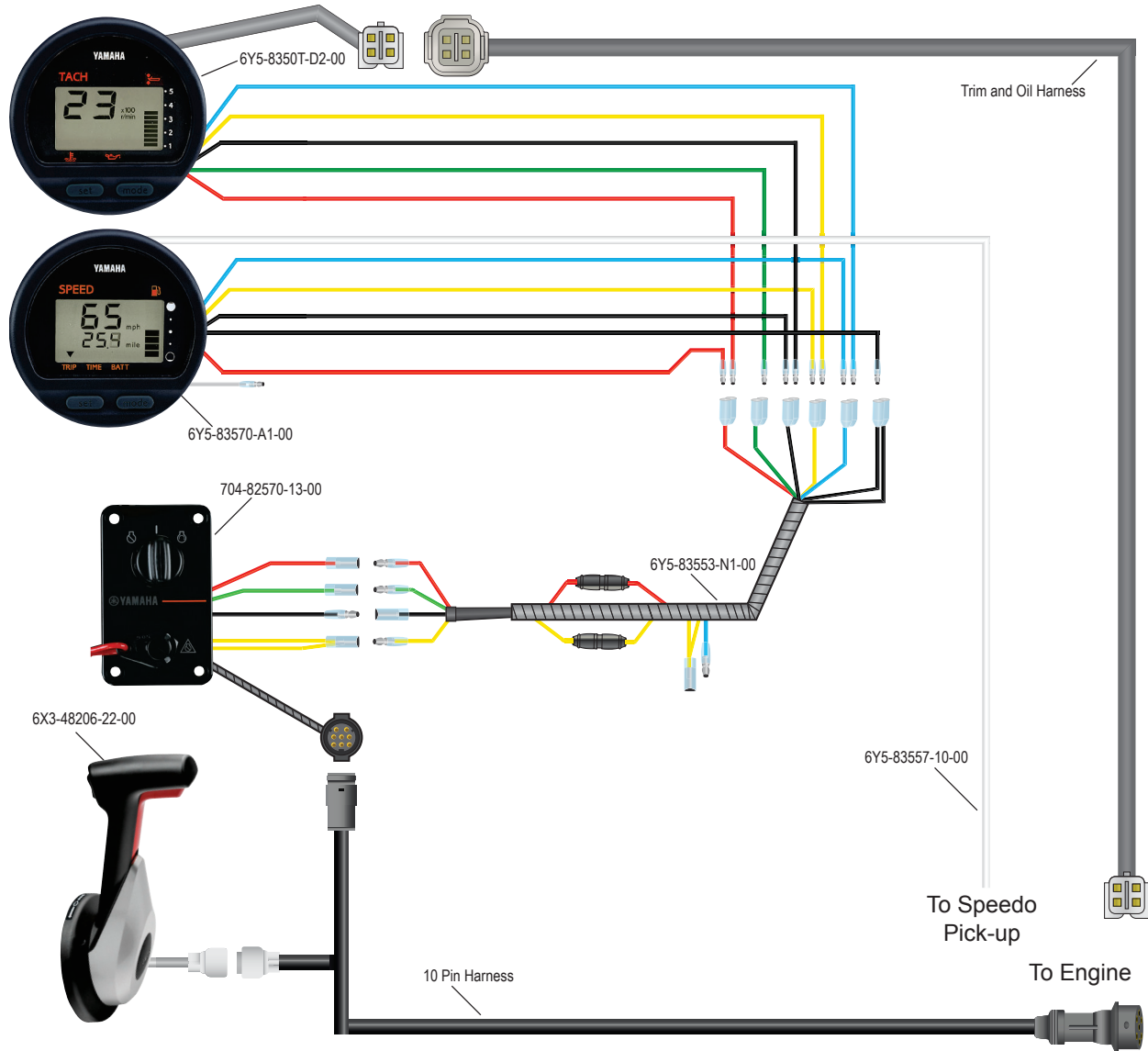

### Parts order list for basic installation:

Quantity	Description	Part Number
1	6x3 Premium Flush Mount Control Box (Left Control)	6X3-48206-22-00
1	Single Engine Key Switch	704-82570-13-00
1	Multifunction Tachometer	6Y5-8350T-D2-00
1	Multifunction Speedometer	6Y5-83570-A1-00
1	Speedometer Tube, 8.0 m	6Y5-83557-10-00
2	Clamp	90465-10098-00
10	Clamp	90465-13M39-00
1	Dual Fuse Harness	6Y5-83553-N1-00
1	10-Pin Main Harness	See List <sup>1</sup>
1	Trim and Oil Harness (2005~)	See List <sup>2</sup>

<sup>1</sup> 10-Pin Harnesses	
16 ft.	688-8258A-50-00
20 ft.	688-8258A-60-00
23 ft.	688-8258A-70-00
26 ft.	6K1-8258A-41-00
31.2 ft.	61B-8258A-02-00
<sup>2</sup> 2005~ Trim and Oil Harness	
16.4 ft.	6Y5-83653-00-00
19.7 ft.	6Y5-83653-10-00
23 ft.	6Y5-83653-20-00
26.3 ft.	6Y5-83653-30-00
30 ft.	6Y5-83653-40-00
35 ft.	6Y5-83653-50-00



# Rigging Estimate Guide

## Single Engine with Mechanical Flush Mount Controls - 6YC Display

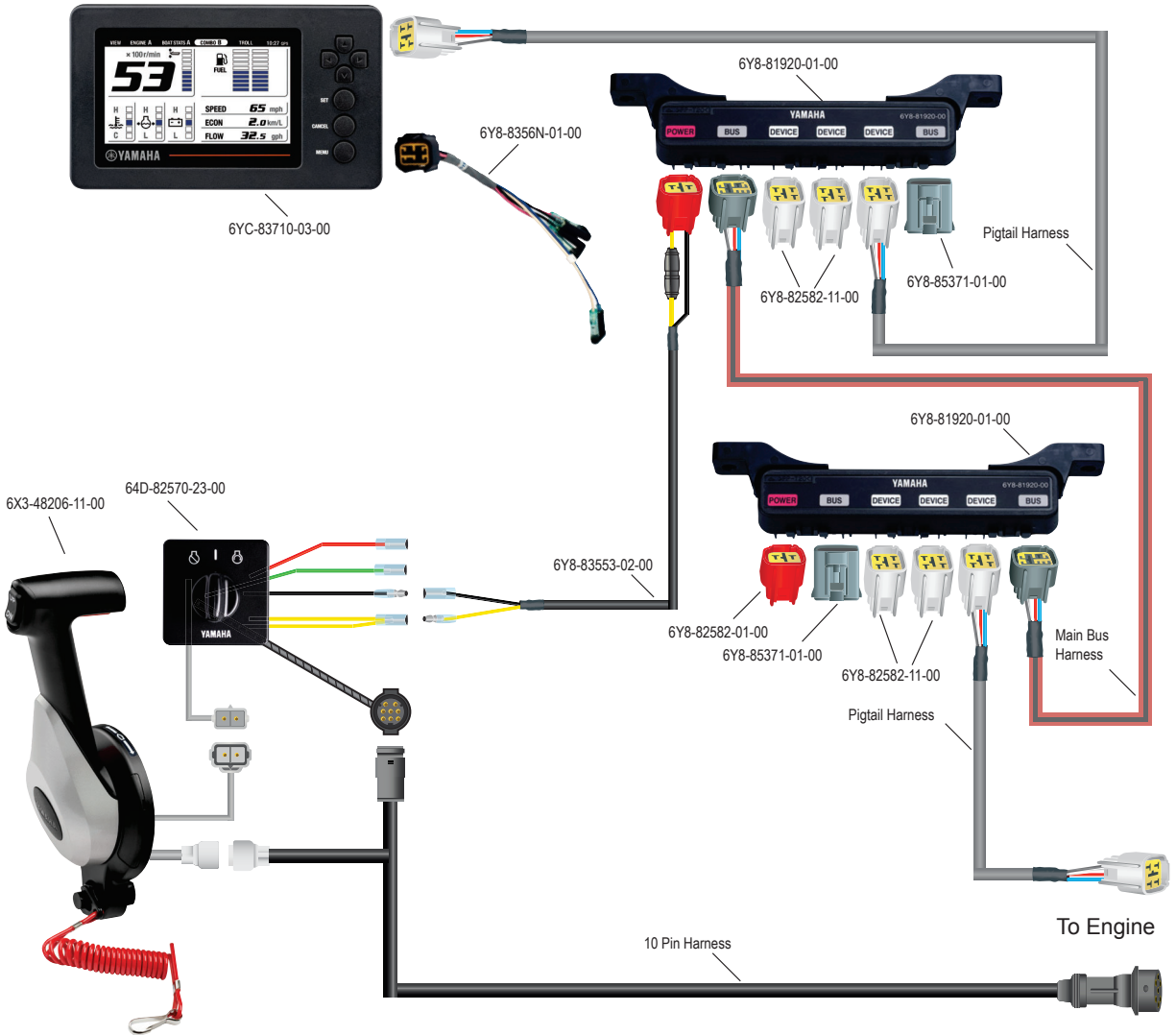

### Parts order list for basic installation:

Quantity	Description	Part Number
1	6x3 Premium Flush Mount Control Box	6X3-48206-11-00
1	Single Engine Key Switch	64D-82570-23-00
1	6YC Display Kit	6YC-0E83C-00-00
1	10-Pin Main Harness	See List <sup>1</sup>
1	Main Bus Harness, Rear Hub to Front Hub	See List <sup>2</sup>
1	Pigtail Harnesses, Front Hub to Display	See List <sup>3</sup>

<sup>1</sup> 10-Pin Harnesses	
16 ft.	688-8258A-50-00
20 ft.	688-8258A-60-00
23 ft.	688-8258A-70-00
26 ft.	6K1-8258A-41-00
31.2 ft.	61B-8258A-02-00
<sup>2</sup> Main Bus Harnesses	
1 ft.	6Y8-82553-01-00
10 ft.	6Y8-82553-50-00
15 ft.	6Y8-82553-11-00
20 ft.	6Y8-82553-21-00
25 ft.	6Y8-82553-31-00
30 ft.	6Y8-82553-41-00
<sup>3</sup> Pigtail Harnesses	
1 ft.	6Y8-82521-01-00
2 ft.	6Y8-82521-11-00
3 ft.	6Y8-82521-21-00
6 ft.	6Y8-82521-31-00
9 ft.	6Y8-82521-41-00
12 ft.	6Y8-82521-51-00

## Single Engine with Binnacle Controls - Multifunction Gauges

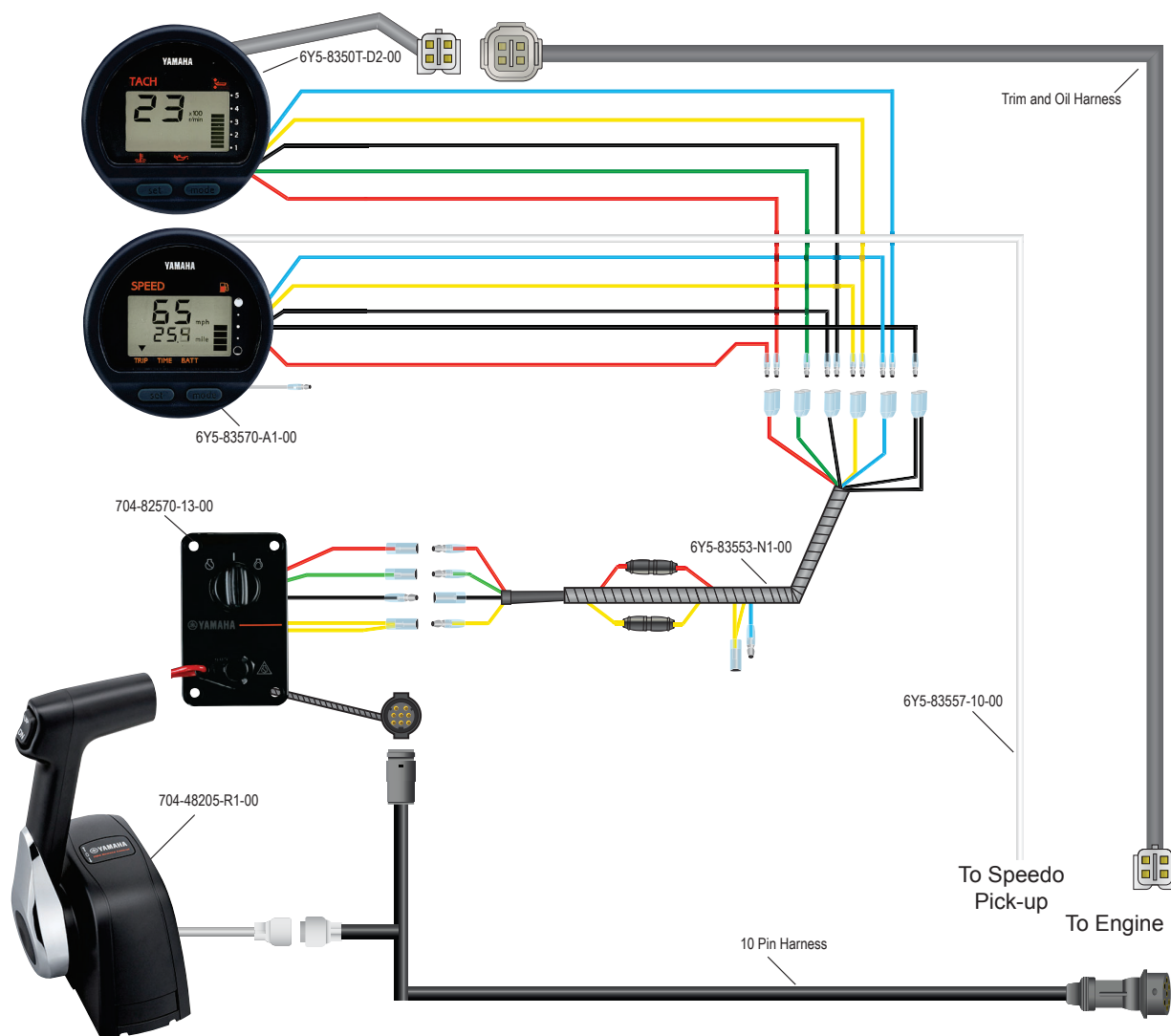

### Parts order list for basic installation:

Quantity	Description	Part Number
1	Premium 704 Single Engine Binnacle Control Box	704-48205-R1-00
1	Single Engine Key Switch	704-82570-13-00
1	Multifunction Tachometer	6Y5-8350T-D2-00
1	Multifunction Speedometer	6Y5-83570-A1-00
1	Speedometer Tube, 8.0 m	6Y5-83557-10-00
2	Clamp	90465-10098-00
10	Clamp	90465-13M39-00
1	Dual Fuse Harness	6Y5-83553-N1-00
1	10-Pin Main Harness	See List <sup>1</sup>
1	Trim and Oil Harness (2005~)	See List <sup>2</sup>

<sup>1</sup> 10-Pin Harnesses	
16 ft.	688-8258A-50-00
20 ft.	688-8258A-60-00
23 ft.	688-8258A-70-00
26 ft.	6K1-8258A-41-00
31.2 ft.	61B-8258A-02-00
<sup>2</sup> 2005~ Trim and Oil Harness	
16.4 ft.	6Y5-83653-00-00
19.7 ft.	6Y5-83653-10-00
23 ft.	6Y5-83653-20-00
26.3 ft.	6Y5-83653-30-00
30 ft.	6Y5-83653-40-00
35 ft.	6Y5-83653-50-00

# Rigging Estimate Guide

## Single Engine with Binnacle Controls - Command Link®

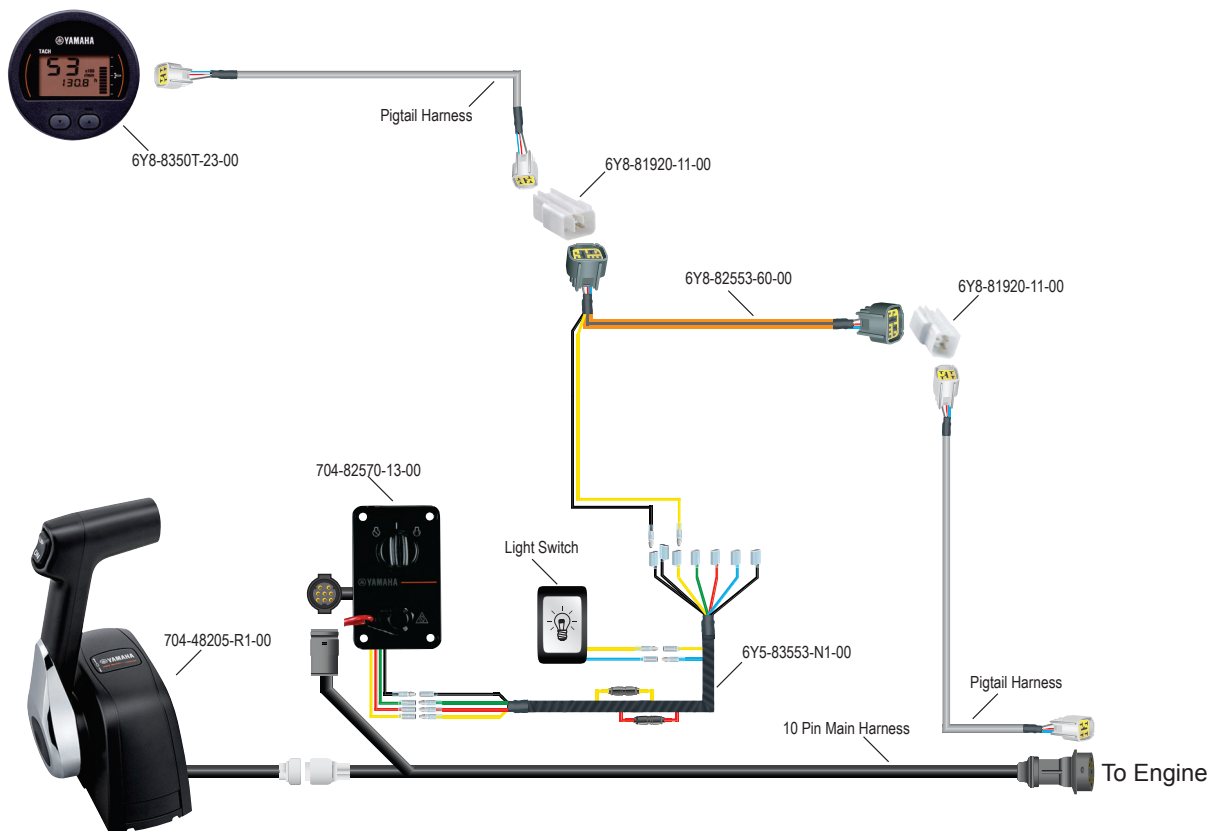

### Parts order list for basic installation:

Quantity	Description	Part Number
1	Premium 704 Single Engine Binnacle Control Box	704-48205-R1-00
1	Single Engine Key Switch	704-82570-13-00
1	Command Link® Round Gauge Kit with In-line Hub	6Y8-0E83R-81-00
1	10-Pin Main Harness	See List <sup>1</sup>

10-Pin Harnesses	
16 ft.	688-8258A-50-00
20 ft.	688-8258A-60-00
23 ft.	688-8258A-70-00
26 ft.	6K1-8258A-41-00
31.2 ft.	61B-8258A-02-00

## Single Engine with Binnacle Controls - Command Link®

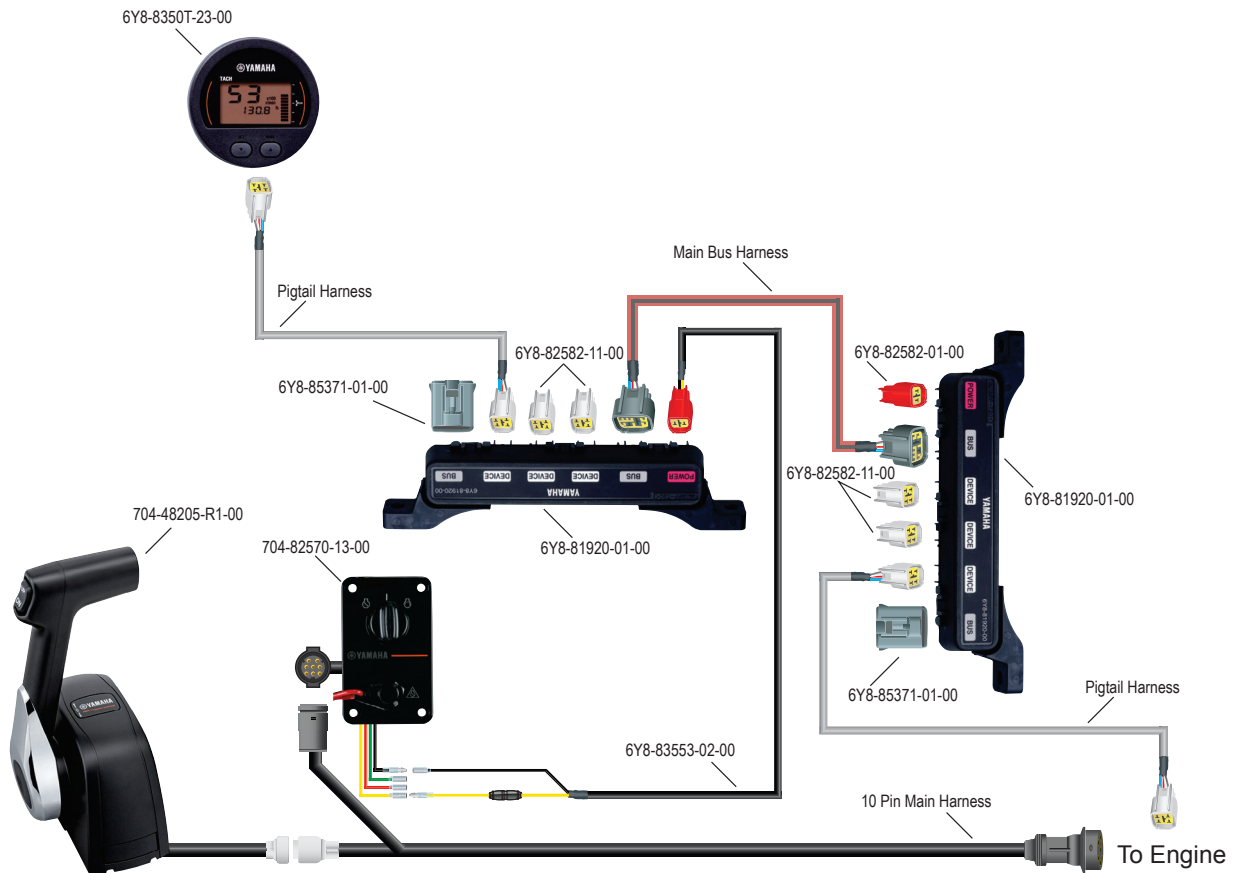

### Parts order list for basic installation:

Quantity	Description	Part Number
1	Premium 704 Single Engine Binnacle Control Box	704-48205-R1-00
1	Single Engine Key Switch	704-82570-13-00
1	Command Link® Round One Gauge Kit	6Y8-0E83R-61-00
1	10-Pin Main Harness	See List <sup>1</sup>
1	Main Bus Harness, Rear Hub to Front Hub	See List <sup>2</sup>
1	Pigtail Harnesses, Front Hub to Gauges	See List <sup>3</sup>

<sup>1</sup> 10-Pin Harnesses	
16 ft.	688-8258A-50-00
20 ft.	688-8258A-60-00
23 ft.	688-8258A-70-00
26 ft.	6K1-8258A-41-00
31.2 ft.	61B-8258A-02-00
<sup>2</sup> Main Bus Harnesses	
1 ft.	6Y8-82553-01-00
10 ft.	6Y8-82553-50-00
15 ft.	6Y8-82553-11-00
20 ft.	6Y8-82553-21-00
25 ft.	6Y8-82553-31-00
30 ft.	6Y8-82553-41-00
<sup>3</sup> Pigtail Harnesses	
1 ft.	6Y8-82521-01-00
2 ft.	6Y8-82521-11-00
3 ft.	6Y8-82521-21-00
6 ft.	6Y8-82521-31-00
9 ft.	6Y8-82521-41-00
12 ft.	6Y8-82521-51-00

# Rigging Estimate Guide

## Single Engine with Binnacle Controls - Command Link®

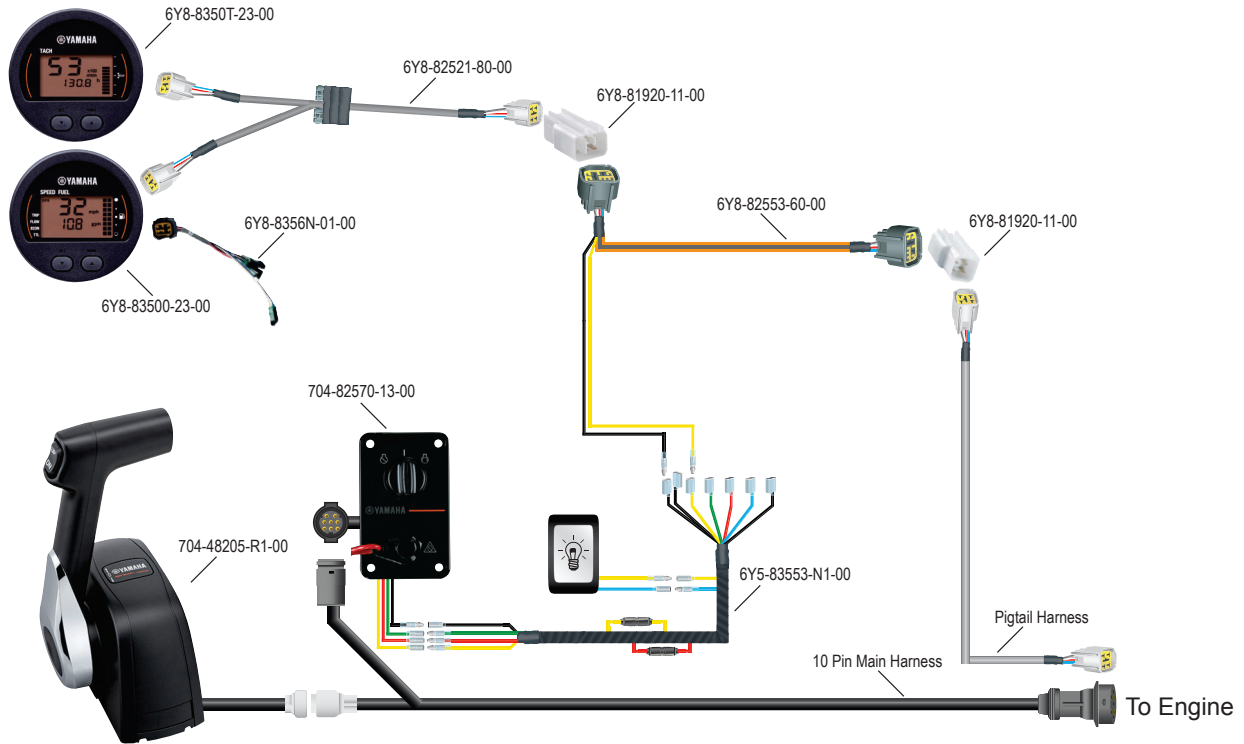

### Parts order list for basic installation:

Quantity	Description	Part Number
1	Premium 704 Single Engine Binnacle Control Box	704-48205-R1-00
1	Single Engine Key Switch	704-82570-13-00
1	Command Link® Round Gauge Kit with In-line Hub	6Y8-0E83R-91-00
1	10-Pin Main Harness	See List <sup>1</sup>

10-Pin Harnesses	
16 ft.	688-8258A-50-00
20 ft.	688-8258A-60-00
23 ft.	688-8258A-70-00
26 ft.	6K1-8258A-41-00
31.2 ft.	61B-8258A-02-00

## Single Engine with Binnacle Controls - Command Link®

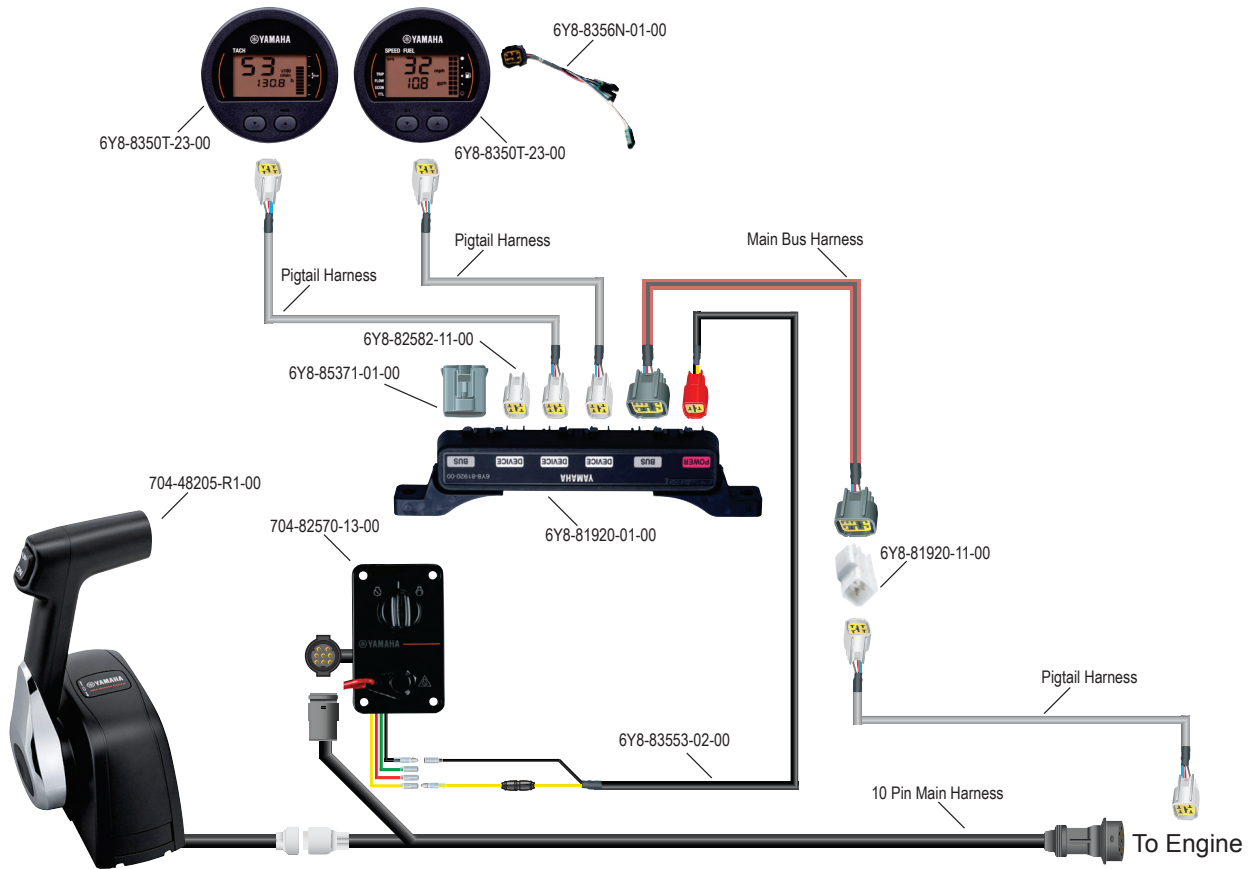

### Parts order list for basic installation:

Quantity	Description	Part Number
1	Premium 704 Single Engine Binnacle Control Box	704-48205-R1-00
1	Single Engine Key Switch	704-82570-13-00
1	Command Link® Round Gauge Kit with In-line Hub	6Y8-0E83R-71-00
1	10-Pin Main Harness	See List <sup>1</sup>
1	Main Bus Harness, Rear In-line Hub to Front Hub	See List <sup>2</sup>
2	Pigtail Harnesses, Front Hub to Gauges	See List <sup>3</sup>

<sup>1</sup> 10-Pin Harnesses	
16 ft.	688-8258A-50-00
20 ft.	688-8258A-60-00
23 ft.	688-8258A-70-00
26 ft.	6K1-8258A-41-00
31.2 ft.	61B-8258A-02-00
<sup>2</sup> Main Bus Harnesses	
1 ft.	6Y8-82553-01-00
10 ft.	6Y8-82553-50-00
15 ft.	6Y8-82553-11-00
20 ft.	6Y8-82553-21-00
25 ft.	6Y8-82553-31-00
30 ft.	6Y8-82553-41-00
<sup>3</sup> Pigtail Harnesses	
1 ft.	6Y8-82521-01-00
2 ft.	6Y8-82521-11-00
3 ft.	6Y8-82521-21-00
6 ft.	6Y8-82521-31-00
9 ft.	6Y8-82521-41-00
12 ft.	6Y8-82521-51-00

General Information

Rigging Estimate Guide (Diagrams)

Rigging Components

Electrical Components

Engine Accessories

Propellers

Maintenance Items

Yamaha & Trailer Supplies

Accessories & Apparel

# Rigging Estimate Guide

## Single Engine with Binnacle Controls - Command Link®

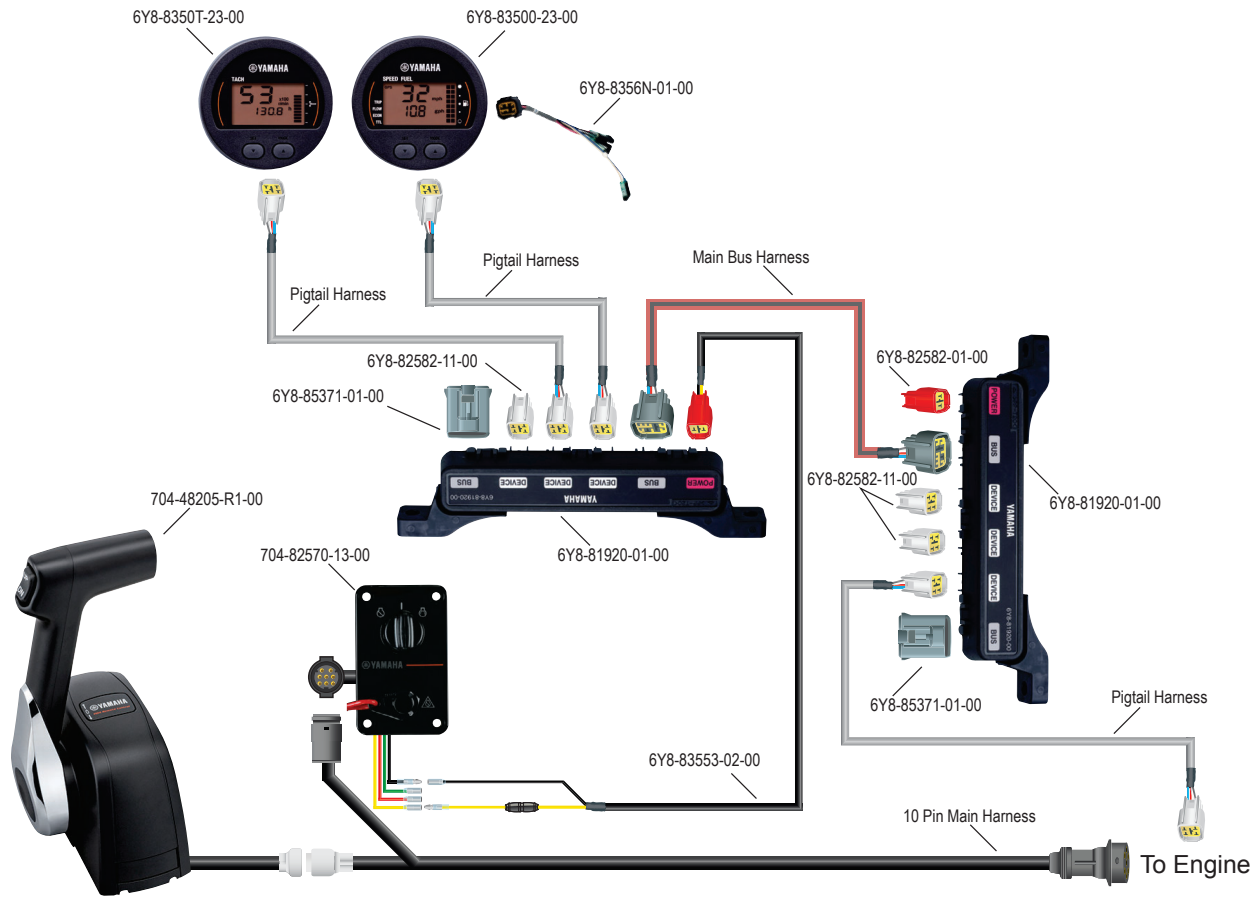

### Parts order list for basic installation:

Quantity	Description	Part Number
1	Premium 704 Single Engine Binnacle Control Box	704-48205-R1-00
1	Single Engine Key Switch	704-82570-13-00
1	Command Link® Round Two Gauge Kit	6Y8-0E83R-41-00
1	10-Pin Main Harness	See List <sup>1</sup>
1	Main Bus Harness, Rear Hub to Front Hub	See List <sup>2</sup>
2	Pigtail Harnesses, Front Hub to Gauges	See List <sup>3</sup>

10-Pin Harnesses	
16 ft.	688-8258A-50-00
20 ft.	688-8258A-60-00
23 ft.	688-8258A-70-00
26 ft.	6K1-8258A-41-00
31.2 ft.	61B-8258A-02-00
2 Main Bus Harnesses	
1 ft.	6Y8-82553-01-00
10 ft.	6Y8-82553-50-00
15 ft.	6Y8-82553-11-00
20 ft.	6Y8-82553-21-00
25 ft.	6Y8-82553-31-00
30 ft.	6Y8-82553-41-00
3 Pigtail Harnesses	
1 ft.	6Y8-82521-01-00
2 ft.	6Y8-82521-11-00
3 ft.	6Y8-82521-21-00
6 ft.	6Y8-82521-31-00
9 ft.	6Y8-82521-41-00
12 ft.	6Y8-82521-51-00

## Single Engine with Binnacle Controls - 6YC Display

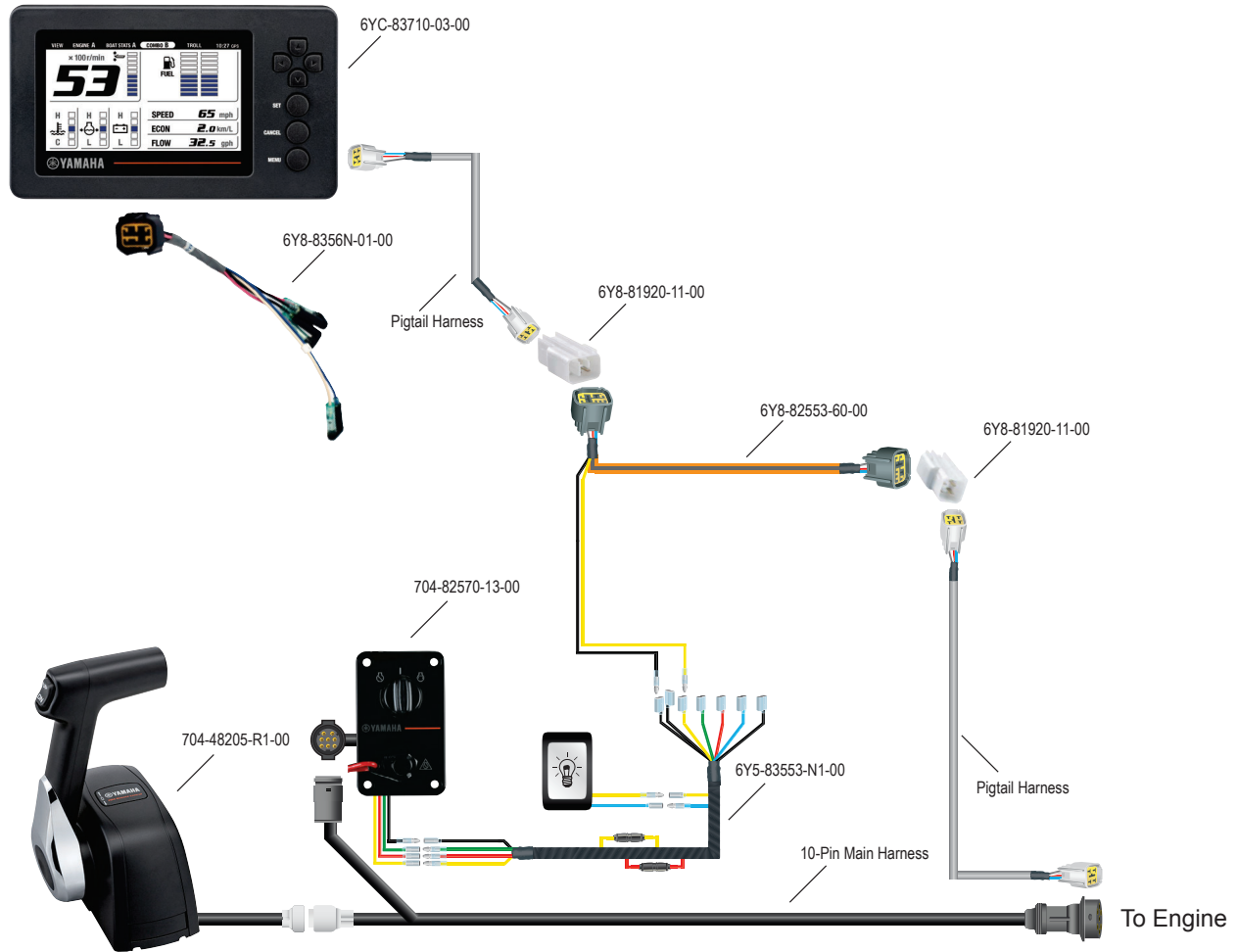

### Parts order list for basic installation:

Quantity	Description	Part Number
1	Premium 704 Single Engine Binnacle Control Box	704-48205-R1-00
1	Single Engine Key Switch	704-82570-13-00
1	6YC Display	6YC-83710-03-00
1	Dual Fuse Harness	6Y5-83553-N1-00
1	Orange Extension Harness (14 ft.)	6Y8-82553-60-00
2	Single Hubs	6Y8-81920-11-00
1	GPS / Fuel Harness	6Y8-8356N-01-00
1	10-Pin Main Harness	See List <sup>1</sup>
1	Pigtail Harness, Engine to Rear Hub	See List <sup>2</sup>
1	Pigtail Harness, Front Hub to Display	See List <sup>2</sup>

10-Pin Harnesses	
16 ft.	688-8258A-50-00
20 ft.	688-8258A-60-00
23 ft.	688-8258A-70-00
26 ft.	6K1-8258A-41-00
31.2 ft.	61B-8258A-02-00
2Pigtail Harnesses	
1 ft.	6Y8-82521-01-00
2 ft.	6Y8-82521-11-00
3 ft.	6Y8-82521-21-00
6 ft.	6Y8-82521-31-00
9 ft.	6Y8-82521-41-00
12 ft.	6Y8-82521-51-00



# Rigging Estimate Guide

## Single Engine with Binnacle Controls - 6YC Display

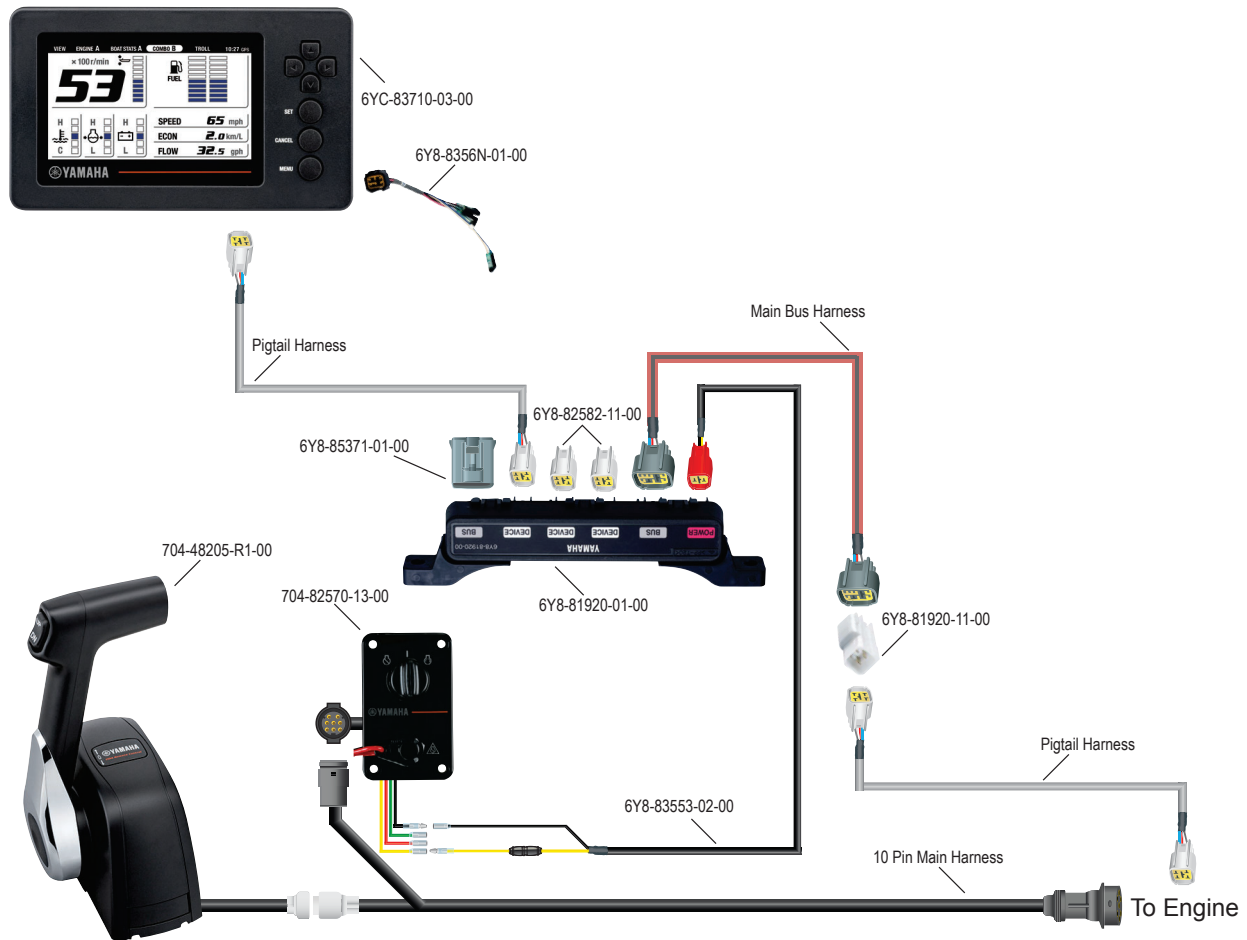

### Parts order list for basic installation:

Quantity	Description	Part Number
1	Premium 704 Single Engine Binnacle Control Box	704-48205-R1-00
1	Single Engine Key Switch	704-82570-13-00
1	6YC Display Kit	6YC-0E83C-10-00
1	10-Pin Main Harness	See List <sup>1</sup>
1	Main Bus Harness, Rear Hub to Front Hub	See List <sup>2</sup>
1	Pigtail Harnesses, Front Hub to Gauges	See List <sup>3</sup>

10-Pin Harnesses	
16 ft.	688-8258A-50-00
20 ft.	688-8258A-60-00
23 ft.	688-8258A-70-00
26 ft.	6K1-8258A-41-00
31.2 ft.	61B-8258A-02-00
2 Main Bus Harnesses	
1 ft.	6Y8-82553-01-00
10 ft.	6Y8-82553-50-00
15 ft.	6Y8-82553-11-00
20 ft.	6Y8-82553-21-00
25 ft.	6Y8-82553-31-00
30 ft.	6Y8-82553-41-00
3 Pigtail Harnesses	
1 ft.	6Y8-82521-01-00
2 ft.	6Y8-82521-11-00
3 ft.	6Y8-82521-21-00
6 ft.	6Y8-82521-31-00
9 ft.	6Y8-82521-41-00
12 ft.	6Y8-82521-51-00

## Single Engine with Binnacle Controls - 6YC Display

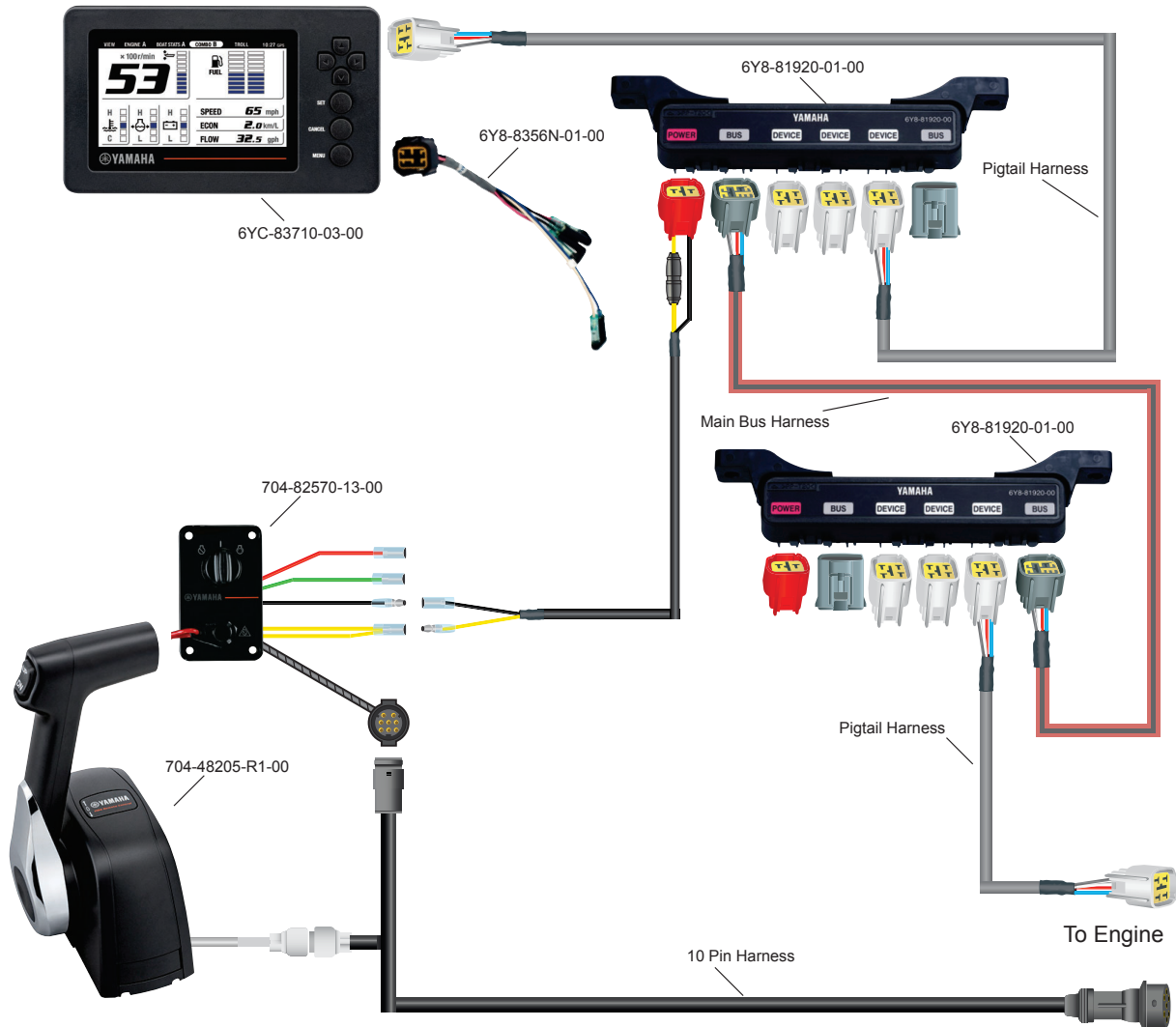

### Parts order list for basic installation:

Quantity	Description	Part Number
1	6YC Display Kit with 704 Remote Control	6YC-0E83C-10-00
1	Main Bus Harness, Rear Hub to Front Hub	See List <sup>1</sup>
1	Pigtail Harnesses, Front Hub to Display	See List <sup>2</sup>

<sup>1</sup> Main Bus Harnesses	
1 ft.	6Y8-82553-01-00
10 ft.	6Y8-82553-50-00
15 ft.	6Y8-82553-11-00
20 ft.	6Y8-82553-21-00
25 ft.	6Y8-82553-31-00
30 ft.	6Y8-82553-41-00
<sup>2</sup> Pigtail Harnesses	
1 ft.	6Y8-82521-01-00
2 ft.	6Y8-82521-11-00
3 ft.	6Y8-82521-21-00
6 ft.	6Y8-82521-31-00
9 ft.	6Y8-82521-41-00
12 ft.	6Y8-82521-51-00

## Helm Master® EX with Flush Mount

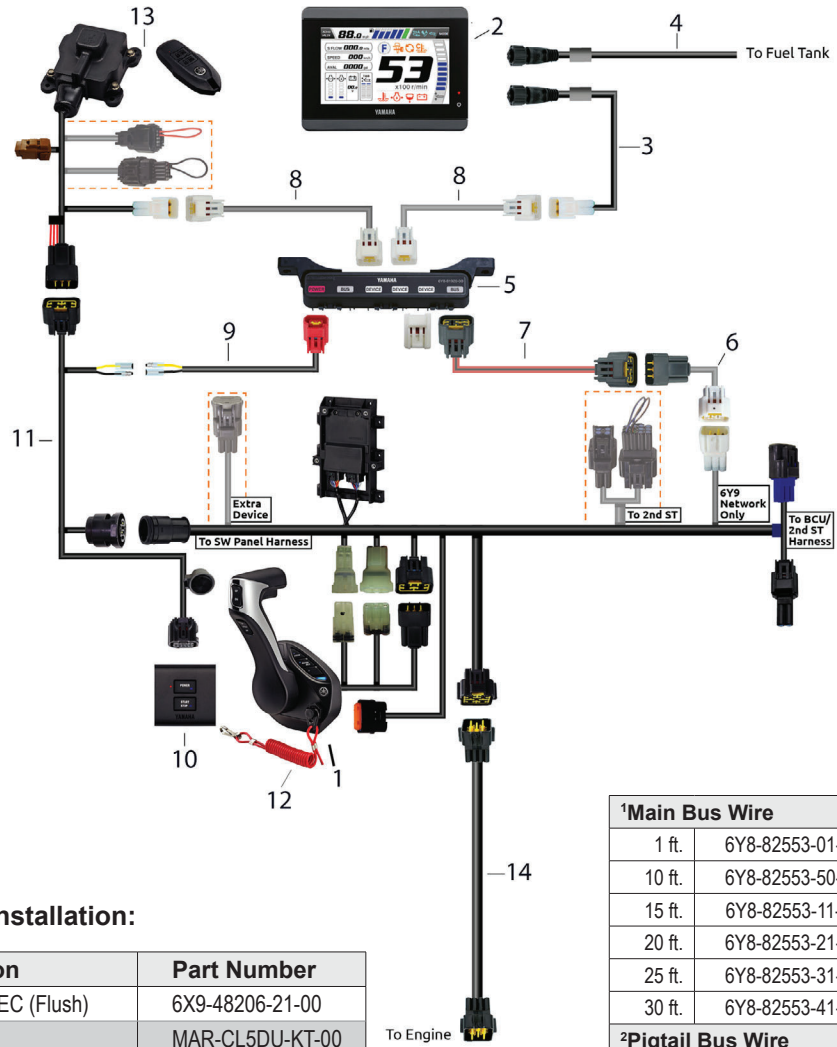

### Parts order list for basic installation:

Ref#	Qty	Description	Part Number
1	1	6x9 Single DEC (Flush)	6X9-48206-21-00
	1	Gauge Kit	MAR-CL5DU-KT-00
2	1	CL5 Display	6YM-83710-17-00
3	1	Conversion Harness	6YM-83553-00-00
	1	CL7/CL5 Install Kit	MAR-CL7D1-KT-30
4	1	Fuel Tank Wire	6YD-8356N-00-00
5	1	Multi-Hub	6Y8-81920-01-00
6	1	Conversion Harness	6Y9-83553-00-00
7	1	Main Bus Wire	See List <sup>1</sup>
8	2	Pigtail Bus Wire	See List <sup>2</sup>
9	1	System Power Supply Wire	6Y8-83553-02-00
	2	4-Pin Waterproof Cap	6Y8-82582-11-00
		EKS Kit*	6X9-762B0-D6-00
10	1	Power Switch Assy	6X9-82570-02-00
11	1	EKS Harness	6X9-82716-21-00
12	1	Emergency Stop Switch	6X9-82570-71-00
13	1	EKS Receiver	6X9-762D0-15-00
14	1	Main-Harness (16P)	See List <sup>3</sup>

<sup>1</sup> Main Bus Wire	
1 ft.	6Y8-82553-01-00
10 ft.	6Y8-82553-50-00
15 ft.	6Y8-82553-11-00
20 ft.	6Y8-82553-21-00
25 ft.	6Y8-82553-31-00
30 ft.	6Y8-82553-41-00
<sup>2</sup> Pigtail Bus Wire	
1 ft.	6Y8-82521-01-00
2 ft.	6Y8-82521-11-00
3 ft.	6Y8-82521-21-00
6 ft.	6Y8-82521-31-00
9 ft.	6Y8-82521-41-00
12 ft.	6Y8-82521-51-00
<sup>3</sup> Main-Harness (16P)	
5 ft.	6X6-8258A-91-00
12 ft.	6X6-8258A-51-00
17 ft.	6X6-8258A-61-00
19 ft.	6X6-8258A-01-00
23 ft.	6X6-8258A-11-00
26 ft.	6X6-8258A-21-00
32 ft.	6X6-8258A-31-00
39 ft.	6X6-8258A-41-00
49 ft.	6X6-8258A-71-00
79 ft.	6X6-8258A-81-00

\*Please Refer to Parts Manager Pro for all EKS Kit components.

## Single Engine Single Station Level 2 EKS

## Helm Master® EX

<b>SINGLE</b>	<b>6X9</b>	<b>CL5</b>	<b>EKS</b>	<b>DES</b>	<b>SINGLE</b>
ENGINE	TOP MOUNT	DISPLAY	SWITCH	INTEGRATED	STATION

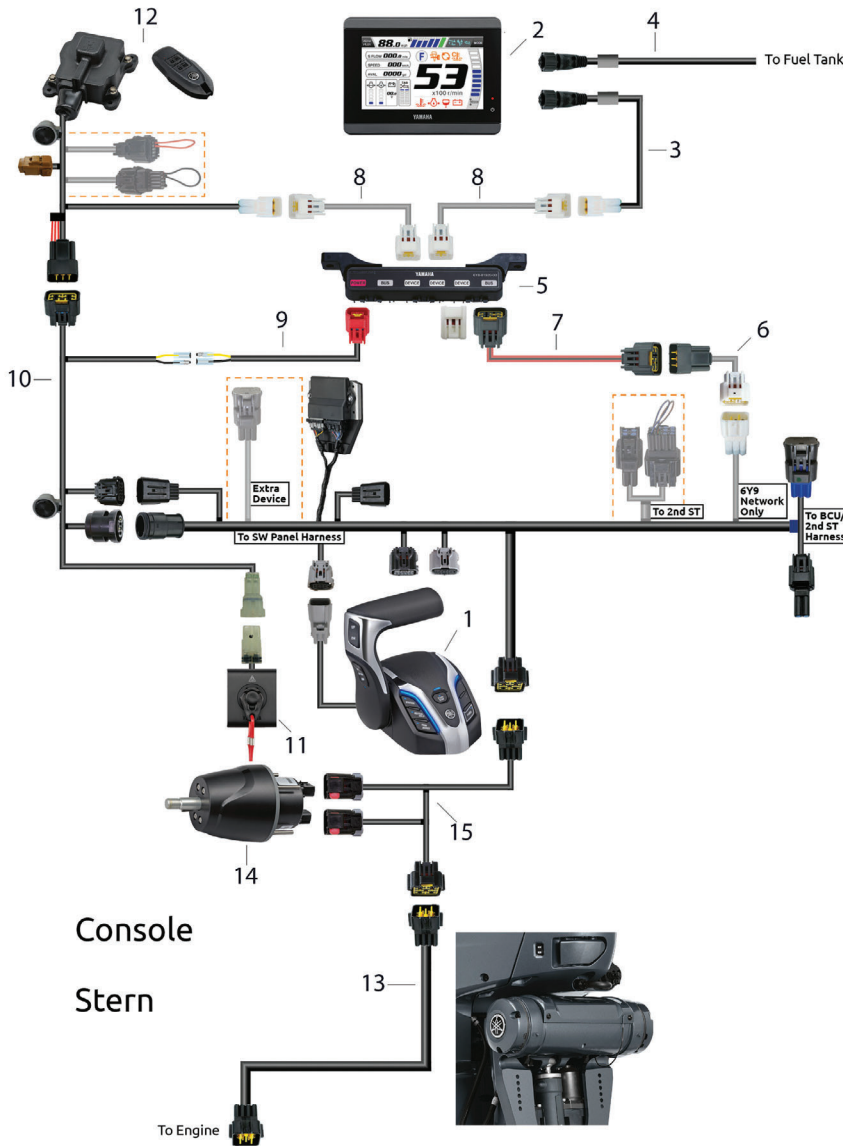

1 Main Bus Wire	
1 ft.	6Y8-82553-01-00
10 ft.	6Y8-82553-50-00
15 ft.	6Y8-82553-11-00
20 ft.	6Y8-82553-21-00
25 ft.	6Y8-82553-31-00
30 ft.	6Y8-82553-41-00
2 Pigtail Bus Wire	
1 ft.	6Y8-82521-01-00
2 ft.	6Y8-82521-11-00
3 ft.	6Y8-82521-21-00
6 ft.	6Y8-82521-31-00
9 ft.	6Y8-82521-41-00
12 ft.	6Y8-82521-51-00
3 Main-Harness (16P)	
5 ft.	6X6-8258A-91-00
12 ft.	6X6-8258A-51-00
17 ft.	6X6-8258A-61-00
19 ft.	6X6-8258A-01-00
23 ft.	6X6-8258A-11-00
26 ft.	6X6-8258A-21-00
32 ft.	6X6-8258A-31-00
39 ft.	6X6-8258A-41-00
49 ft.	6X6-8258A-71-00
79 ft.	6X6-8258A-81-00
4 Helm Harness (Main/Single)	
3 ft.	6GR-8258A-01-00
6 ft.	6GR-8258A-41-00

### Parts order list for basic installation:

Ref #	Qty	Description	Part Number
1	1	6x9 Single Binnacle	6X9-48205-22-00
	1	Gauge Kit	MAR-CL5DU-KT-00
2	1	CL5 Display	6YM-83710-17-00
3	1	Conversion Harness	6YM-83553-00-00
	1	CL7/CL5 Install Kit	MAR-CL7D1-KT-30
4	1	Fuel Tank Wire	6YD-8356N-00-00
5	1	Multi-Hub	6Y8-81920-01-00
6	1	Conversion Harness	6Y9-83553-00-00
7	1	Main Bus Wire	See List <sup>1</sup>
8	2	Pigtail Bus Wire	See List <sup>2</sup>
9	1	System Power Supply Wire	6Y8-83553-02-00
	2	4-Pin Waterproof Cap	6Y8-82582-11-00

Ref #	Qty	Description	Part Number
		EKS Kit*	6X9-762E0-42-00
10	1	EKS Harness	6X9-82716-21-00
11	1	Engine Shut Off Switch	6X9-82570-71-00
12	1	EKS Receiver	6X9-762D0-15-00
13	1	Main-Harness (16P)	See List <sup>3</sup>

	1	Helm and Tilt kit	6GR-762H0-11-00
	1	Helm Unit Assy	6GR-615A0-11-00
	1	Tilt Helm Unit	6GR-6154A-01-00
14	1	Helm Unit Assy	6X9-762H0-10-00
15	1	Helm harness (Main/Single)	See List <sup>4</sup>

\*Please Refer to Parts Manager Pro for all EKS Kit components.

# Rigging Estimate Guide

## Single Engine Single Station Level 2 6X6

## Helm Master® EX

<b>SINGLE</b> ENGINE	<b>6X9</b> TOP MOUNT	<b>CL5</b> DISPLAY	<b>STD</b> SWITCH	<b>DES</b> BOLT ON	<b>SINGLE</b> STATION
-------------------------	-------------------------	-----------------------	----------------------	-----------------------	--------------------------

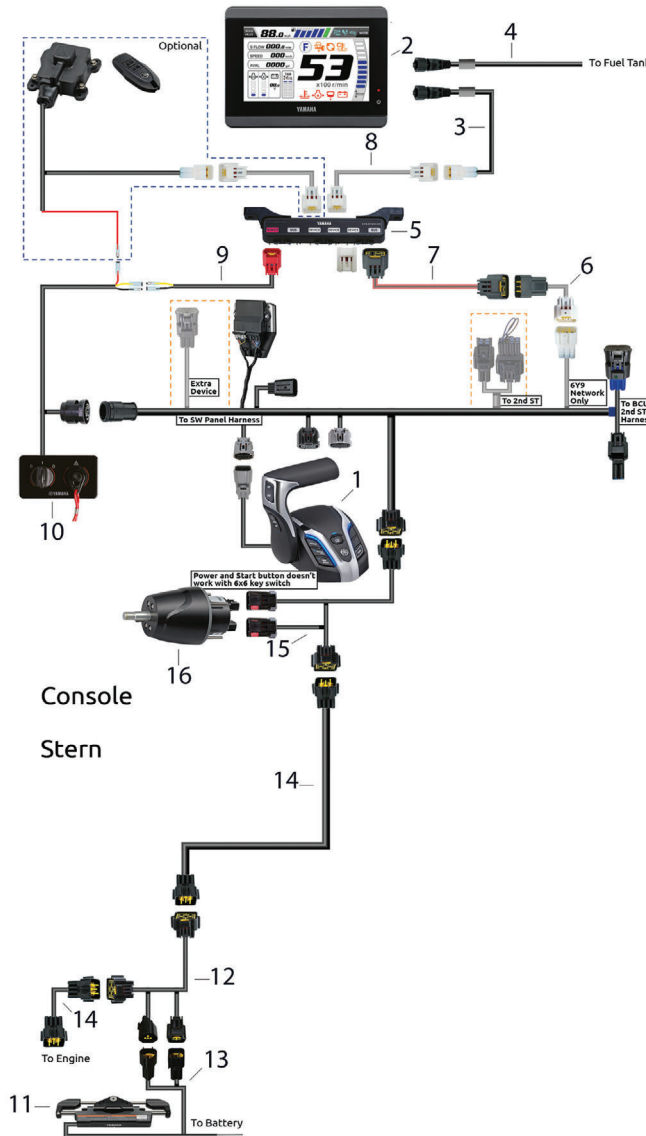

1 Main Bus Wire	
1 ft.	6Y8-82553-01-00
10 ft.	6Y8-82553-50-00
15 ft.	6Y8-82553-11-00
20 ft.	6Y8-82553-21-00
25 ft.	6Y8-82553-31-00
30 ft.	6Y8-82553-41-00
2 Pigtail Bus Wire	
1 ft.	6Y8-82521-01-00
2 ft.	6Y8-82521-11-00
3 ft.	6Y8-82521-21-00
6 ft.	6Y8-82521-31-00
9 ft.	6Y8-82521-41-00
12 ft.	6Y8-82521-51-00
3 Steering Actuator Harness	
8 ft.	6X9-438A0-01-00
15 ft.	6X9-438A0-11-00
4 Main-Harness (16P)	
5 ft.	6X6-8258A-91-00
12 ft.	6X6-8258A-51-00
17 ft.	6X6-8258A-61-00
19 ft.	6X6-8258A-01-00
23 ft.	6X6-8258A-11-00
26 ft.	6X6-8258A-21-00
32 ft.	6X6-8258A-31-00
39 ft.	6X6-8258A-41-00
49 ft.	6X6-8258A-71-00
79 ft.	6X6-8258A-81-00
5 Helm Harness (Main/Single)	
3 ft.	6GR-8258A-01-00
6 ft.	6GR-8258A-41-00

### Parts order list for basic installation:

Ref #	Qty	Description	Part Number
1	1	6x9 Single DEC	6X9-48205-22-00
	1	Gauge Kit	MAR-CL5DU-KT-00
2	1	CL5 Display	6YM-83710-17-00
3	1	Conversion Harness	6YM-83553-00-00
	1	CL7/CL5 Install Kit DEC	MAR-CL7D1-KT-30
4	1	Fuel Tank Wire	6YD-8356N-00-00
5	1	Multi-Hub	6Y8-81920-01-00
6	1	Conversion Harness	6Y9-83553-00-00
7	1	Main Bus Wire	See List <sup>1</sup>
8	1	Pigtail Bus Wire	See List <sup>2</sup>
9	1	System Power Supply Wire	6Y8-83553-02-00
	2	4-Pin Waterproof Cap	6Y8-82582-11-00
10	1	Main Switch	6X6-82570-34-00

Ref #	Qty	Description	Part Number
	1	Steering Kit	6X9-762S0-03-00
11	1	Bolt-on Steering Actuator	6X9-42401-11-00
12	1	Split Harness	6X9-8258A-90-00
13	1	Steering Actuator Harness	See List <sup>3</sup>
14	1	Main-Harness (16P)	See List <sup>4</sup>
	1	Helm and Tilt Kit	6GR-762H0-11-00
	1	Helm Unit Assembly	6GR-615A0-11-00
	1	Tilt Helm Unit	6GR-6154A-01-00
15	1	Helm Unit Assembly	6X9-762H0-10-00
16	1	Helm Harness (Main/Single)	See List <sup>5</sup>

## Helm Master EX® – Single Engine Maneuverability Kit for Built In Electric Steering

<b>SINGLE</b> ENGINE	<b>6X9</b> TOP MOUNT	<b>MFDI-2</b> HDMI Display	<b>EKS</b> SWITCH	<b>DES</b> INTEGRATED	<b>SINGLE</b> STATION	<b>HM-EX</b> FULL MANEUVER
-------------------------	-------------------------	-------------------------------	----------------------	--------------------------	--------------------------	-------------------------------

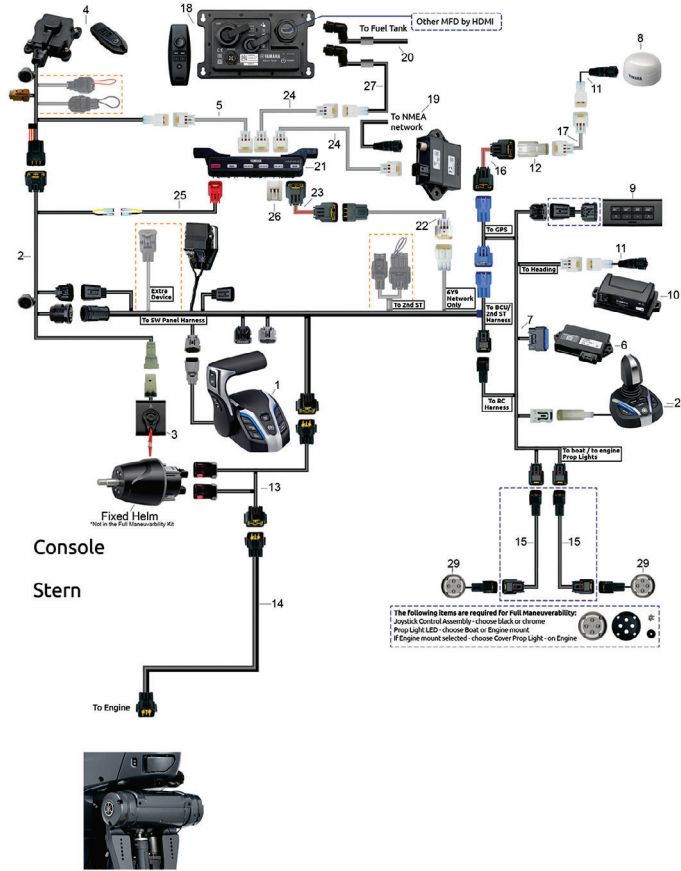

1 Main Bus Wire	
1 ft.	6Y8-82553-01-00
10 ft.	6Y8-82553-50-00
15 ft.	6Y8-82553-11-00
20 ft.	6Y8-82553-21-00
25 ft.	6Y8-82553-31-00
30 ft.	6Y8-82553-41-00
2 Pigtail Bus Wire	
1 ft.	6Y8-82521-01-00
2 ft.	6Y8-82521-11-00
3 ft.	6Y8-82521-21-00
6 ft.	6Y8-82521-31-00
9 ft.	6Y8-82521-41-00
12 ft.	6Y8-82521-51-00
3 Main-Harness (16P)	
5 ft.	6X6-8258A-91-00
12 ft.	6X6-8258A-51-00
17 ft.	6X6-8258A-61-00
19 ft.	6X6-8258A-01-00
23 ft.	6X6-8258A-11-00
26 ft.	6X6-8258A-21-00
32 ft.	6X6-8258A-31-00
39 ft.	6X6-8258A-41-00
49 ft.	6X6-8258A-71-00
79 ft.	6X6-8258A-81-00
4 Helm Harness (Main/Multi)	
3 ft.	6GR-8258A-11-00
6 ft.	6GR-8258A-51-00
9 ft.	6GR-8258A-61-00
5 BCU Extension Harness	
3 ft.	6X9-82521-00-00
30 ft.	6X9-82521-10-00
8 Prop Light Extension Harness	
20 ft.	6X9-82586-20-00
30 ft.	6X9-82586-30-00
40 ft.	6X9-82586-40-00

### Parts order list for basic installation:

Ref #	Qty	Description	Part Number
		Single Engine Maneuverability Kit	MAR-HMEX1-XT-10
1	1	DEC Single Main Station	6X9-48205-22-00
	1	Electronic Key Switch	6X9-762E0-42-00
2	1	EKS Harness	6X9-82716-21-00
3	1	Engine Shut-off Switch	6X9-82570-71-00
4	1	Key Fob and Receiver Assy	6X9-762D0-15-00
5	1	2ft Pigtail	6Y8-82521-11-00
	1	Helm And Tilt Kit	6GR-762H0-11-00
Not Shown	1	Helm Unit Assembly	6GR-615A0-11-00
Not Shown	1	Tilt Helm Unit	6GR-615A4-01-00
Not Shown	1	Tilt Helm Instruction Manual	6GR-2819K-L1-00
Maneuverability Components			
6	1	Boat Control Unit- Single	6X9-8591T-15-00
7	1	Boat Control Unit Harness	6X9-82386-02-00
8	1	GPS Unit	6X9-88107-02-00
9	1	Autopilot Control Panel Assembly	6X9-8253V-02-00
10	1	Heading Sensor Unit	6X9-8A410-02-00
11	2	Wire Lead	6YM-83553-00-00
12	1	In-Line Hub Assembly	6Y8-81920-11-00
14	1	In-Line Hub Assembly	6Y8-81920-11-00

Not Included in the Single Maneuverability Kit After this point*			
13	1	Helm Harness (Main/Multi Engine)*	See List 4
14	1	Main Harness (16P) (Remote Control to Engine)*	See List 3
15	2	Prop Light Extension Harness*	See List 6
16	1	Main Bus Harness (Remote Control to GPS Antenna)*	See list 1
17	1	Pigtail Harness (1FT & 2FT only)*	See List 2

Ref #	Qty	Description	Part Number
	1	Main Bus Harness (Multi-Hub to Remote Control)*	See List 1
	1	Pigtail Harness (Multi-Hub to Display)*	See List 2
	1	Gauge Kit*	MAR-CL000-KT-00
18		CLO Unit & Remote Control	6YM-8A201-01-00
Not Shown		HDMI Cable	6YM-8533A-00-00
19		Gateway NMEA 2000 Wire	6YG-82521-00-00
	1	MFD Interface Install Kit*	MAR-CL0D1-KT-00
20		Fuel Tank Wire	6YM-8356N-00-00
21		Multi-Hub	6Y8-81920-01-00
22		Conversion Harness	6Y9-83553-00-00
23		Main Bus Wire	See List 1
24		Pigtail Bus Wire	See List 2
25		System Power Supply Wire	6Y8-83553-02-00
26		4-Pin Waterproof Cap	6Y8-82582-11-00
27		CLO Conversion Harness	6YM-83553-10-00
28	1	Joystick Controller Assembly*	6X9-482A0-02-00 (Chrome)
or	1	Joystick Controller Assembly*	6X9-482A0-10-00 (Black)
29	2	Prop Light LED Assembly (Transom)*	6ES-83720-03-00
OR	2	Prop Light LED Assembly (On Engine)*	6KN-762A0-00-00
		Gray on Engine Prop Light Cover 4.2L*	6KA-42723-10-8D
		White on Engine Prop Light Cover 4.2L*	6KA-42723-10-CE
		Gray on Engine Prop Light Cover 2.8L*	6LH-42723-10-8D
		White on Engine Prop Light Cover 2.8L*	6LH-42723-10-CE

# Rigging Estimate Guide

## Single Engine Second Station Full Maneuverability Helm Master® EX

<b>SINGLE</b> ENGINE	<b>6X9</b> TOP MOUNT	<b>CL5</b> DISPLAY	<b>EKS</b> SWITCH	<b>SECOND</b> STATION	<b>HM-EX</b> FULL MANEUVER
-------------------------	-------------------------	-----------------------	----------------------	--------------------------	-------------------------------

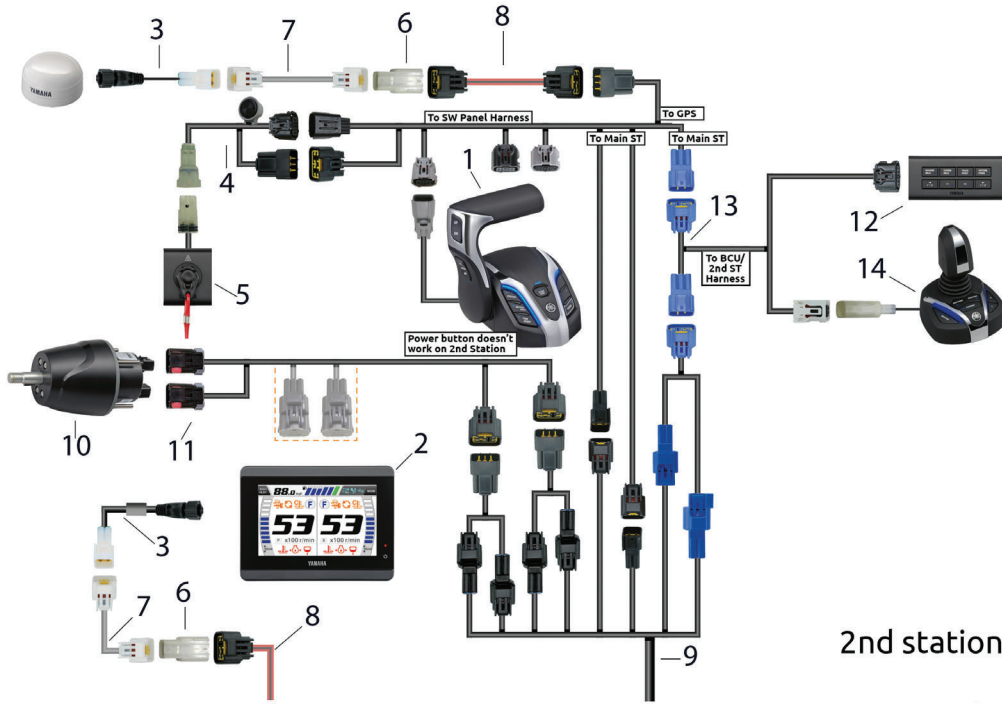

\* Additional for 2nd Station XTO 425 only - Single engines and P and S only for multi engine configs



### Parts order list for basic installation:

#### Level 1

Ref #	Qty	Description	Part Number
1	1	6x9 Single Binnacle	6X9-48205-30-00
	1	Gauge Kit	MAR-CL5DU-KT-00
2	1	CL5 Display	6YM-83710-17-00
3	1	Conversion Harness	6YM-83553-00-00
	1	EKS Kit	6X9-762E0-81-00
4	1	EKS Harness	6X9-82716-60-00
5	1	Emergency Stop SW	6X9-82570-71-00
	1	Rigging Components Needed	
6	1	Single-Hub	6Y8-81920-11-00
7	1	Pigtail Bus Wire	See List <sup>1</sup>
8	1	Main Bus Wire	See List <sup>2</sup>
9	1	2nd Helm Harness	See List <sup>3</sup>

#### Level 2

Ref #	Qty	Description	Part Number
		Helm and Tilt Kit	6GR-762H0-11-00
	1	Helm Unit Assembly	6GR-615A0-10-00
	1	Tilt Helm Unit	6GR-6154A-01-00
10	1	Helm Unit Assembly	6X9-762H0-10-00
11	1	Helm Harness (2nd station)	6X9-8258A-B1-00

#### Level 3

Ref #	Qty	Description	Part Number
	1	Autopilot Kit	6X9-762P0-12-00
12	1	Autopilot Panel	6X9-8253V-02-00
13	1	BCU Harness	6X9-82386-10-00
	1	BCU Harness Extension	See List <sup>4</sup>

#### Level 4

Ref #	Qty	Description	Part Number
14	1	Joystick Controller Assy	6X9-482A0-02-00 (Chrome)

<sup>1</sup> Pigtail Bus Wire	
1 ft.	6Y8-82521-01-00
2 ft.	6Y8-82521-11-00
3 ft.	6Y8-82521-21-00
6 ft.	6Y8-82521-31-00
9 ft.	6Y8-82521-41-00
12 ft.	6Y8-82521-51-00
<sup>2</sup> 2nd Helm Harness	
16 ft.	6X9-8258A-01-00
26 ft.	6X9-8258A-11-00
38 ft.	6X9-8258A-21-00

<sup>2</sup> Main Bus Wire	
1 ft.	6Y8-82553-01-00
10 ft.	6Y8-82553-50-00
15 ft.	6Y8-82553-11-00
20 ft.	6Y8-82553-21-00
25 ft.	6Y8-82553-31-00
30 ft.	6Y8-82553-41-00
<sup>4</sup> BCU Extension Harness	
15 ft.	6X9-82521-00-00
30 ft.	6X9-82521-10-00

\*\*Additional for 2nd Station XTO Only.  
6GR-8258A-V0-00

## Twin Engines with Mechanical Binnacle Controls - Multifunction Gauges

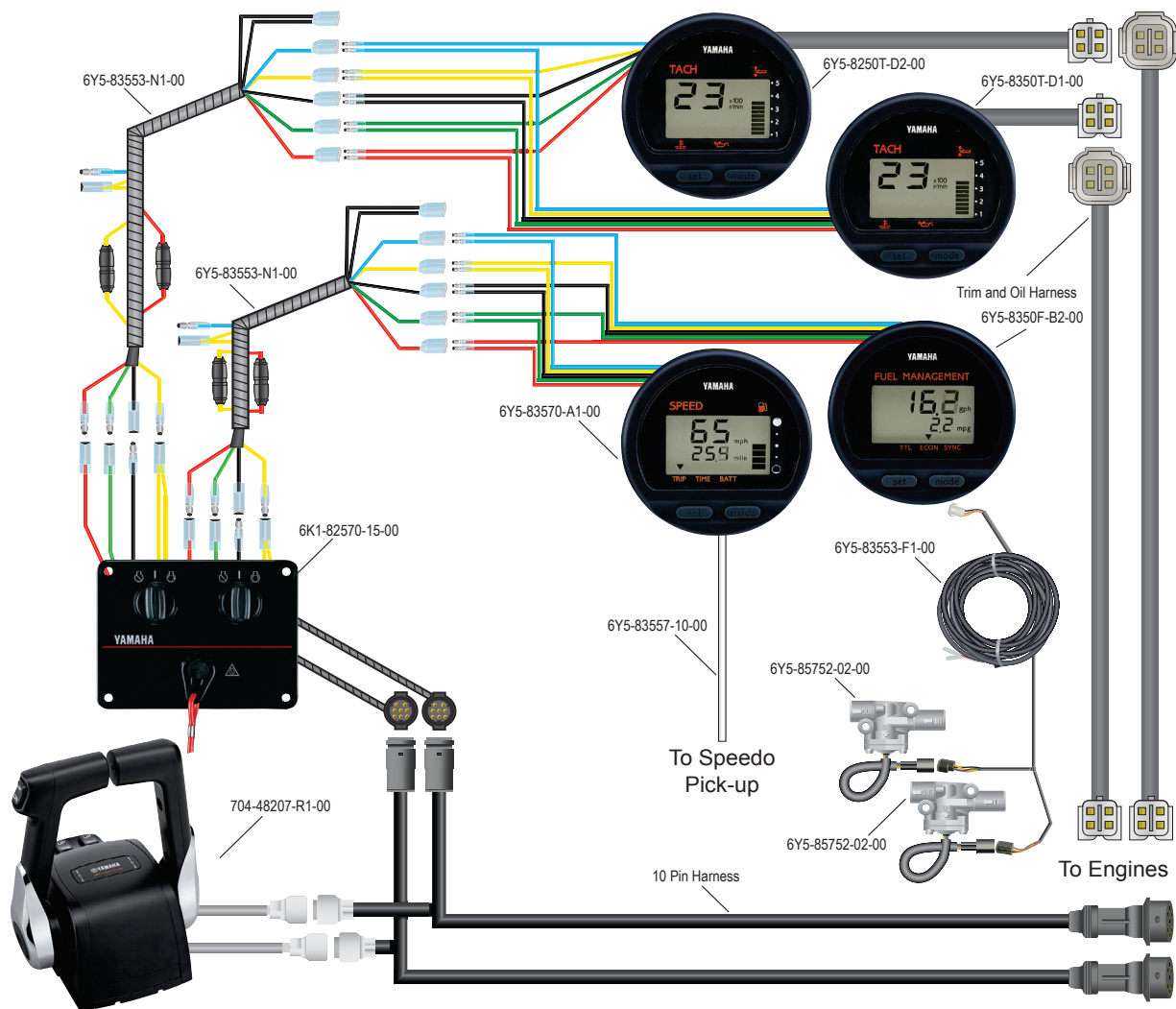

### Parts order list for basic installation:

Quantity	Description	Part Number
1	Twin Engine 704 Control Box	704-48207-R1-00
1	Twin Engine Key Switch Panel	6K1-82570-15-00
2	Multifunction Tachometer	6Y5-8250T-D2-00
1	Multifunction Speedometer	6Y5-83570-A1-00
1	Multifunction Fuel Meter Kit	6Y5-W0088-56-00
2	Fuel Flow Sensor (extra for twins)	6Y5-85752-02-00
1	Speedometer Tube, 8.0 m	6Y5-83557-10-00
2	Dual Fuse Harness	6Y5-83553-N1-00
2	Clamp	90465-10098-00
10	Clamp	90465-13M39-00
2	10 Pin Main Harness	See List <sup>1</sup>
2	Trim and Oil Harness (2005~)	See List <sup>2</sup>

10-Pin Harnesses	
16 ft.	688-8258A-50-00
20 ft.	688-8258A-60-00
23 ft.	688-8258A-70-00
26 ft.	6K1-8258A-41-00
31.2 ft.	61B-8258A-02-00
2005~ Trim and Oil Harness	
16.4 ft.	6Y5-83653-00-00
19.7 ft.	6Y5-83653-10-00
23 ft.	6Y5-83653-20-00
26.3 ft.	6Y5-83653-30-00
30 ft.	6Y5-83653-40-00
35 ft.	6Y5-83653-50-00



# Rigging Estimate Guide

## Twin Engines with Mechanical Binnacle Controls - Command Link®

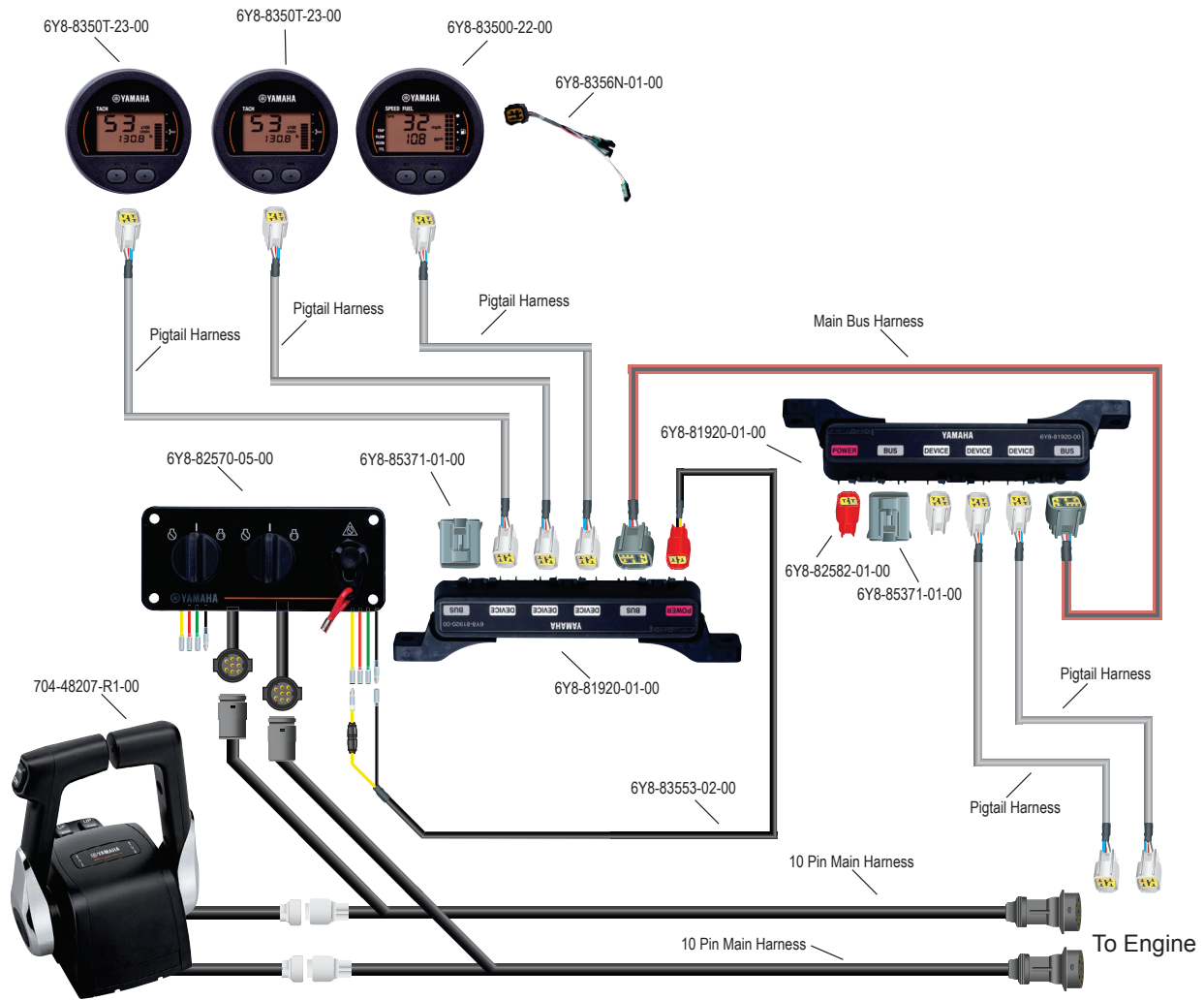

### Parts order list for basic installation:

Quantity	Description	Part Number
1	Command Link® Twin Engine Three Gauge Kit w/ 704 Control	6Y8-0E83R-51-00
1	Main Bus Harness, Rear Hub to Front Hub	See List <sup>1</sup>
3	Pigtail Harness, Front Hub to Gauges	See List <sup>2</sup>

1Main Bus Harnesses	
1 ft.	6Y8-82553-01-00
10 ft.	6Y8-82553-50-00
15 ft.	6Y8-82553-11-00
20 ft.	6Y8-82553-21-00
25 ft.	6Y8-82553-31-00
30 ft.	6Y8-82553-41-00
2Pigtail Harnesses	
1 ft.	6Y8-82521-01-00
2 ft.	6Y8-82521-11-00
3 ft.	6Y8-82521-21-00
6 ft.	6Y8-82521-31-00
9 ft.	6Y8-82521-41-00
12 ft.	6Y8-82521-51-00

## Twin Engines Mechanical Binnacle Control - Command Link Plus®

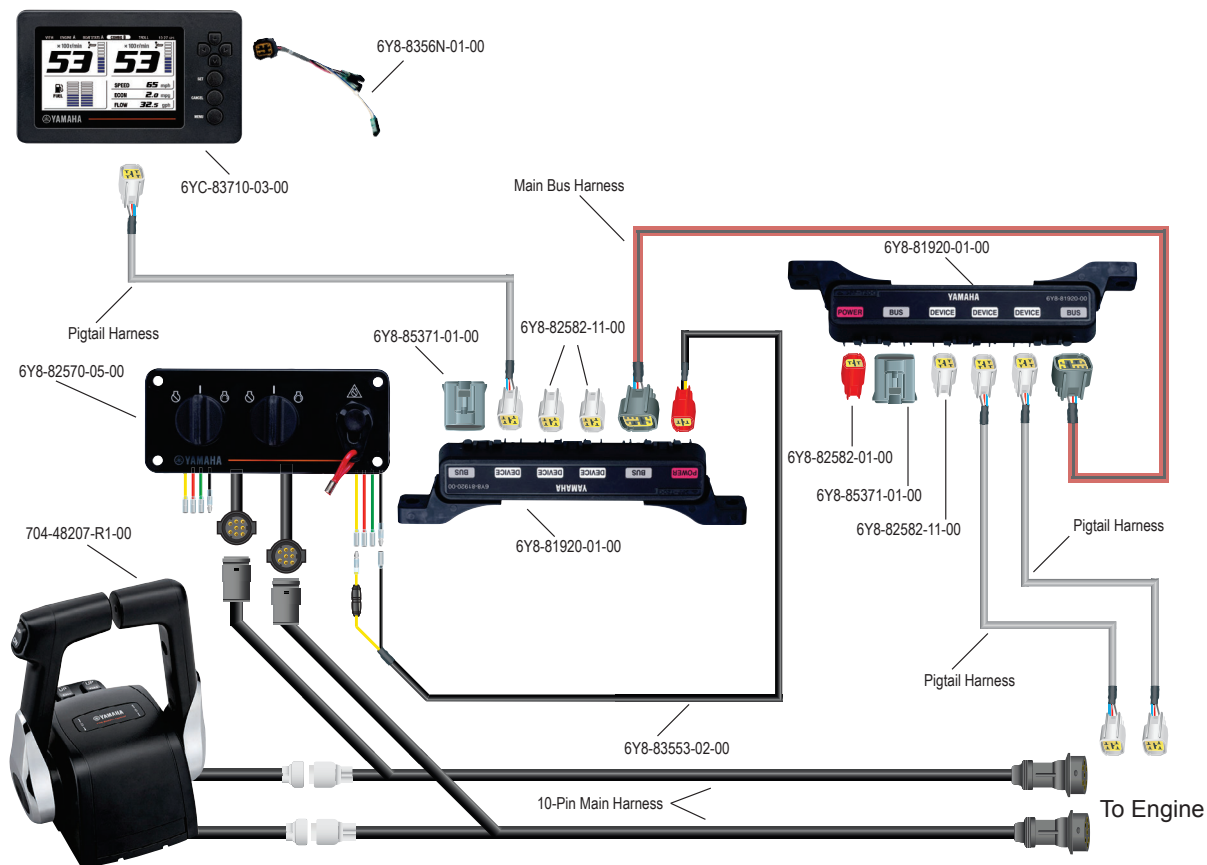

### Parts order list for basic installation:

Quantity	Description	Part Number
1	6YC Display Kit with 704 Remote Control	6YC-0E83C-20-00
1	Main Bus Harness, Rear Hub to Front Hub	See List <sup>1</sup>
1	Pigtail Harnesses, Front Hub to Gauges	See List <sup>2</sup>

<sup>1</sup> Main Bus Harnesses	
1 ft.	6Y8-82553-01-00
10 ft.	6Y8-82553-50-00
15 ft.	6Y8-82553-11-00
20 ft.	6Y8-82553-21-00
25 ft.	6Y8-82553-31-00
30 ft.	6Y8-82553-41-00
<sup>2</sup> Pigtail Harnesses	
1 ft.	6Y8-82521-01-00
2 ft.	6Y8-82521-11-00
3 ft.	6Y8-82521-21-00
6 ft.	6Y8-82521-31-00
9 ft.	6Y8-82521-41-00
12 ft.	6Y8-82521-51-00

# Rigging Estimate Guide

## Twin Engine Single Station Level 2 EKS

## Helm Master® EX

<b>TWIN</b> ENGINE	<b>6X9</b> TOP MOUNT	<b>CL5</b> DISPLAY	<b>EKS</b> SWITCH	<b>DES</b> INTEGRATED	<b>SINGLE</b> STATION
-----------------------	-------------------------	-----------------------	----------------------	--------------------------	--------------------------

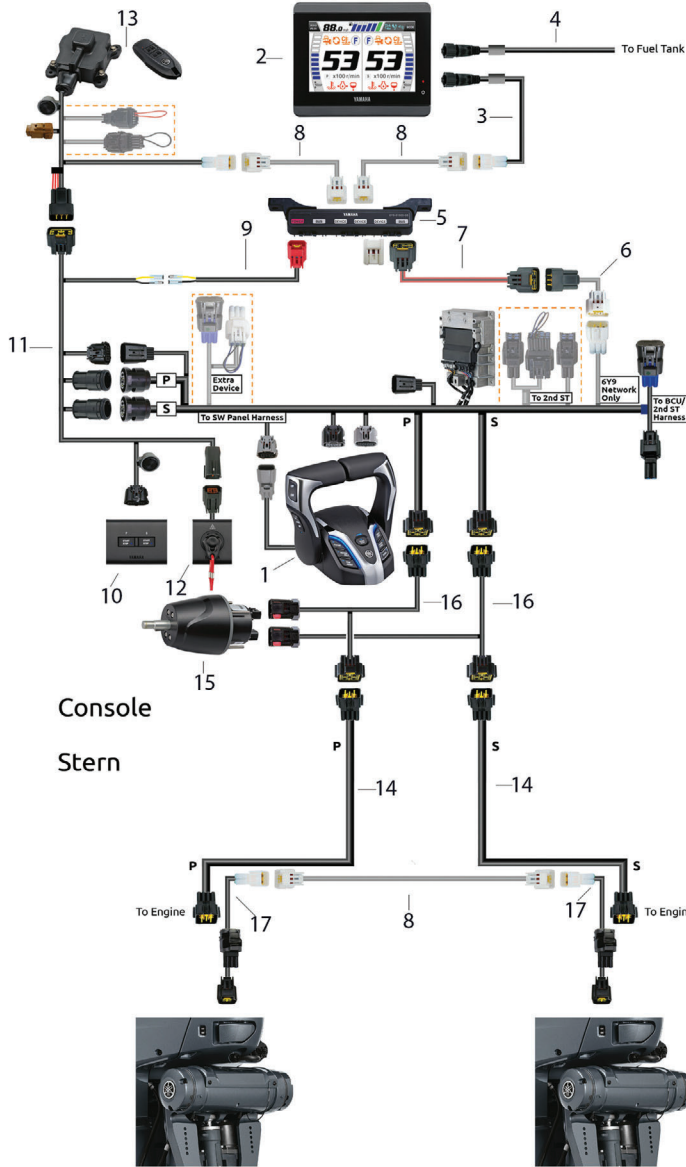

1 Main Bus Wire	
1 ft.	6Y8-82553-01-00
10 ft.	6Y8-82553-50-00
15 ft.	6Y8-82553-11-00
20 ft.	6Y8-82553-21-00
25 ft.	6Y8-82553-31-00
30 ft.	6Y8-82553-41-00
2 Pigtail Bus Wire	
1 ft.	6Y8-82521-01-00
2 ft.	6Y8-82521-11-00
3 ft.	6Y8-82521-21-00
6 ft.	6Y8-82521-31-00
9 ft.	6Y8-82521-41-00
12 ft.	6Y8-82521-51-00
3 Steering Actuator Harness	
8 ft.	6X9-438A0-01-00
15 ft.	6X9-438A0-11-00
4 Main-Harness (16P)	
5 ft.	6X6-8258A-91-00
12 ft.	6X6-8258A-51-00
17 ft.	6X6-8258A-61-00
19 ft.	6X6-8258A-01-00
23 ft.	6X6-8258A-11-00
26 ft.	6X6-8258A-21-00
32 ft.	6X6-8258A-31-00
39 ft.	6X6-8258A-41-00
49 ft.	6X6-8258A-71-00
79 ft.	6X6-8258A-81-00
5 Helm Harness (Main/Multi)	
3 ft.	6GR-8258A-11-00
6 ft.	6GR-8258A-51-00
9 ft.	6GR-8258A-61-00
6 SCU Link Harness (Port/Stbd)	
1 ft.	6X9-81115-00-00
5 ft.	6GR-81115-00-00
10 ft.	6GR-81115-10-00

### Parts order list for basic installation:

Ref #	Qty	Description	Part Number
1	1	6x9 Twin DEC	6X9-48207-22-00
	1	Gauge Kit	MAR-CL5DU-KT-00
2	1	CL5 Display	6YM-83710-17-00
3	1	Conversion Harness	6YM-83553-00-00
	1	CL7/CL5 Install Kit	MAR-CL7D1-KT-30
4	1	Fuel Tank Wire	6YD-8356N-00-00
5	1	Multi-Hub	6Y8-81920-01-00
6	1	Conversion Harness	6Y9-83553-00-00
7	1	Main Bus Wire	See List <sup>1</sup>
8	2	Pigtail Bus Wire	See List <sup>2</sup>
9	1	System Power Supply Wire	6Y8-83553-02-00
	2	4-Pin Waterproof Cap	6Y8-82582-11-00

Ref #	Qty	Description	Part Number
	1	EKS Kit*	6X9-762E0-52-00
10	1	Power Switch	6X9-82570-12-00
11	1	EKS Harness	6X9-82716-32-00
12	1	Emergency Stop Switch	6X9-82570-81-00
13	1	Key Fob and Receiver Assembly	6X9-762D0-15-00
14	2	Main-Harness (16P)	See List <sup>4</sup>
	1	Helm and Tilt Kit	6GR-762H0-11-00
	1	Helm Unit Assembly	6GR-615A0-11-00
	1	Tilt Helm Unit	6GR-6154A-01-00
15	1	Helm Unit Assembly	6X9-762H0-10-00
16	2	Helm Harness (Main/Multi)	See List <sup>5</sup>
17	2	SCU Link Harness (Port/Stbd)	See List <sup>6</sup>

\*Please Refer to Parts Manager Pro for all EKS Kit components.

## Twin Engine Single Station Level 2 6X6

## Helm Master® EX

<b>TWIN</b> ENGINE	<b>6X9</b> TOP MOUNT	<b>CL5</b> DISPLAY	<b>STD</b> SWITCH	<b>DES</b> BOLT ON	<b>SINGLE</b> STATION
-----------------------	-------------------------	-----------------------	----------------------	-----------------------	--------------------------

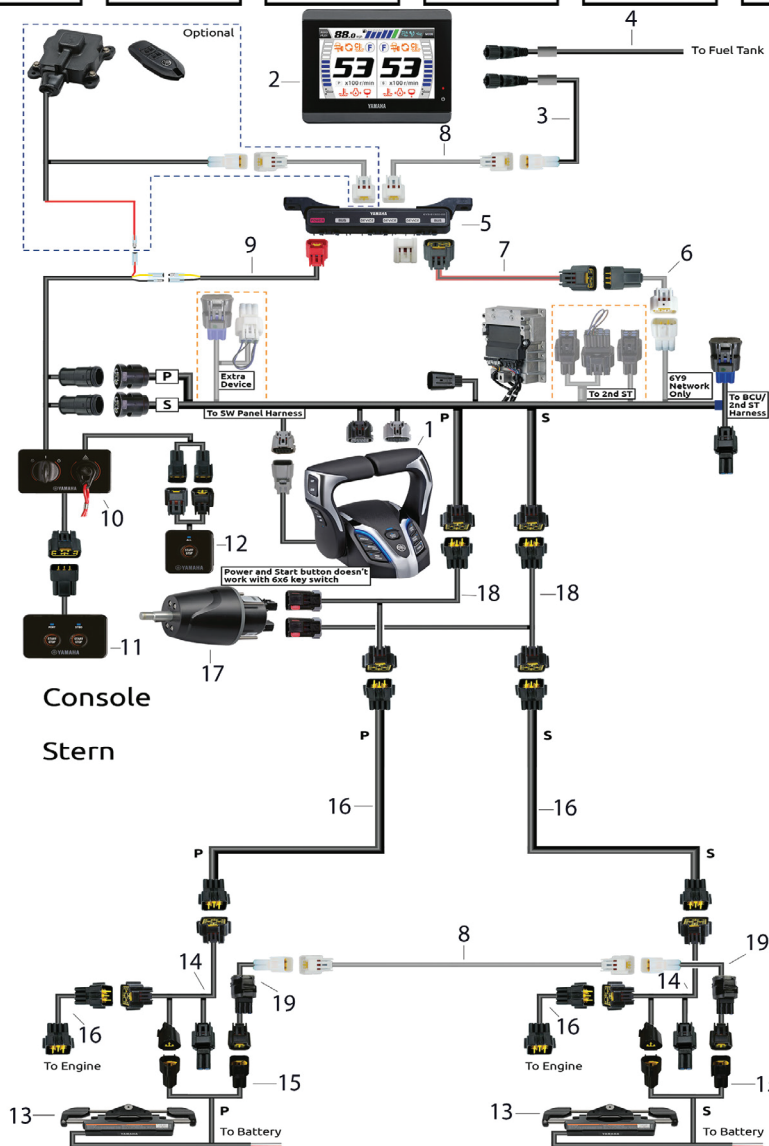

1 Main Bus Wire	
1 ft.	6Y8-82553-01-00
10 ft.	6Y8-82553-50-00
15 ft.	6Y8-82553-11-00
20 ft.	6Y8-82553-21-00
25 ft.	6Y8-82553-31-00
30 ft.	6Y8-82553-41-00
2 Pigtail Bus Wire	
1 ft.	6Y8-82521-01-00
2 ft.	6Y8-82521-11-00
3 ft.	6Y8-82521-21-00
6 ft.	6Y8-82521-31-00
9 ft.	6Y8-82521-41-00
12 ft.	6Y8-82521-51-00
3 Steering Actuator Harness	
8 ft.	6X9-438A0-01-00
15 ft.	6X9-438A0-11-00
4 Main-Harness (16P)	
5 ft.	6X6-8258A-91-00
12 ft.	6X6-8258A-51-00
17 ft.	6X6-8258A-61-00
19 ft.	6X6-8258A-01-00
23 ft.	6X6-8258A-11-00
26 ft.	6X6-8258A-21-00
32 ft.	6X6-8258A-31-00
39 ft.	6X6-8258A-41-00
49 ft.	6X6-8258A-71-00
79 ft.	6X6-8258A-81-00
5 Helm Harness (Main/Multi)	
3 ft.	6GR-8258A-11-00
6 ft.	6GR-8258A-51-00
9 ft.	6GR-8258A-61-00
6 SCU Link Harness (Port/Stbd)	
1 ft.	6X9-81115-00-00
5 ft.	6GR-81115-00-00
10 ft.	6GR-81115-10-00

### Parts order list for basic installation:

Ref #	Qty	Description	Part Number
1	1	6X9 Twin DEC	6X9-48207-22-00
	1	Gauge Kit	MAR-CL5DU-KT-00
2	1	CL5 Display	6YM-83710-17-00
3	1	Conversion Harness	6YM-83553-00-00
	1	CL7/CL5 Install Kit	MAR-CL7D1-KT-30
4	1	Fuel Tank Wire	6YD-8356N-00-00
5	1	Multi-Hub	6Y8-81920-01-00
6	1	Conversion Harness	6Y9-83553-00-00
7	1	Main Bus Wire	See List <sup>1</sup>
8	1	Pigtail Bus Wire	See List <sup>2</sup>
9	1	System Power Supply Wire	6Y8-83553-02-00
	2	4-Pin Waterproof Cap	6Y8-82582-11-00
	1	Switch Kit	6X6-762B0-01-00
10	1	Main Switch	6X6-82570-41-00

Ref #	Qty	Description	Part Number
11	1	Twin Start/Stop Switch	6X6-82570-60-00
12	1	All Start/Stop Switch	6X6-82570-D0-00
	2	Steering Kit	6X9-762S0-03-00
13	2	Bolt-on Steering Actuator	6X9-42401-11-00
14	2	Split Harness	6X9-8258A-90-00
15	2	Steering Actuator Harness	See List <sup>3</sup>
16	2	Main-Harness (16P)	See List <sup>4</sup>
	1	Helm and Tilt Kit	6GR-762H0-11-00
	1	Helm Unit Assembly	6GR-615A0-11-00
	1	Tilt Helm Unit	6GR-615A4-01-00
17	1	Helm Unit Assembly	6X9-762H0-10-00
18	2	Helm Harness (Main/Multi)	See List <sup>5</sup>
19	2	SCU Link Harness (Port/Stbd)	See List <sup>6</sup>

## Twin Engine Maneuverability Kit for Built In Electric Steering

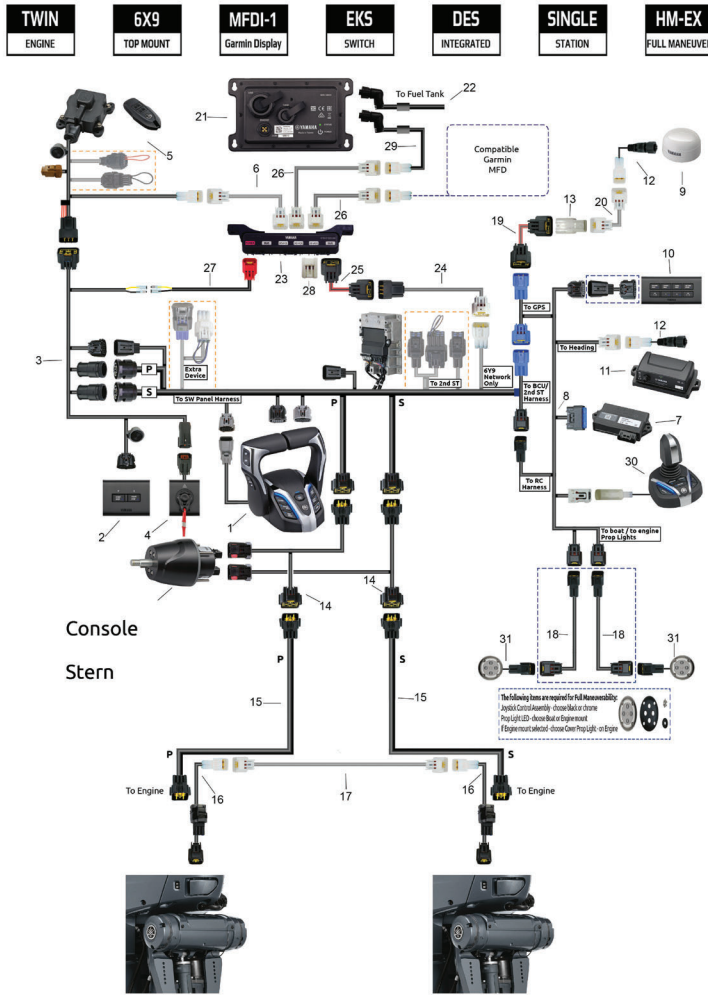

## Helm Master® EX

1 Main Bus Wire	
1 ft.	6Y8-82553-01-00
10 ft.	6Y8-82553-50-00
15 ft.	6Y8-82553-11-00
20 ft.	6Y8-82553-21-00
25 ft.	6Y8-82553-31-00
30 ft.	6Y8-82553-41-00
2 Pigtail Bus Wire	
1 ft.	6Y8-82521-01-00
2 ft.	6Y8-82521-11-00
3 ft.	6Y8-82521-21-00
6 ft.	6Y8-82521-31-00
9 ft.	6Y8-82521-41-00
12 ft.	6Y8-82521-51-00
3 Main-Harness (16P)	
5 ft.	6X6-8258A-91-00
12 ft.	6X6-8258A-51-00
17 ft.	6X6-8258A-61-00
19 ft.	6X6-8258A-01-00
23 ft.	6X6-8258A-11-00
26 ft.	6X6-8258A-21-00
32 ft.	6X6-8258A-31-00
39 ft.	6X6-8258A-41-00
49 ft.	6X6-8258A-71-00
79 ft.	6X6-8258A-81-00
4 Helm Harness (Main/Multi)	
3 ft.	6GR-8258A-11-00
6 ft.	6GR-8258A-51-00
9 ft.	6GR-8258A-61-00
5 SCU Link Harness (Port/Stbd)	
1 ft.	6X9-81115-00-00
5 ft.	6GR-81115-00-00
10 ft.	6GR-81115-10-00
6 SCU Link Harness (Center)	
1 ft.	6X9-81115-10-00
5 ft.	6GR-81115-20-00
10 ft.	6GR-81115-30-00
7 BCU Extension Harness	
15 ft.	6X9-82521-00-00
30 ft.	6X9-82521-10-00
8 Prop Light Extension Harness	
20 ft.	6X9-82586-20-00
30 ft.	6X9-82586-30-00
40 ft.	6X9-82586-40-00

### Parts order list for basic installation:

Ref #	Qty	Description	Part Number
		Triple Engine Maneuverability Kit	MAR-HMEX2-XT-10
1	1	DEC Twin Main Station	6X9-48207-22-00
	1	Electronic Key Switch	6X9-762E0-52-00
2		Individual Start/Stop SW	6X9-82570-32-00
3		EKS Harness	6X9-82716-32-00
4		Engine Shut-off Switch	6X9-82570-81-00
5		Key Fob and Receiver Assy	6X9-762D0-15-00
6		2ft Pigtail	6Y8-82521-11-00
	1	Helm Components	6GR-762H0-11-00
Not Shown		Helm Unit Assembly	6GR-615A0-11-00
Not Shown		Tilt Helm Unit	6GR-6154A-01-00
Not Shown		Tilt Helm Instruction Manual	6GR-2819K-L1-00
Maneuverability Components			
7	1	Boat Control Unit- Triple	6X9-8591T-25-00
8	1	Boat Control Unit Harness	6X9-82386-02-00
9	1	GPS Unit	6X9-88107-02-00
10	1	Autopilot Control Panel Assembly	6X9-8253V-02-00
11	1	Heading Sensor Unit	6X9-8A410-02-00
12	2	Wire Lead	6YM-83553-00-00
13	1	In-Line Hub Assembly	6Y8-81920-11-00

Not Included in the Twin Maneuverability Kit After this point*			
14	2	Helm Harness (Main/Multi Engine)*	See List <sup>4</sup>
15	2	Main Harness (16P) (Remote Control to Engine) *	See List <sup>3</sup>
16	2	SCU Link P/S*	See List <sup>5</sup>
17	2	Pigtail Harness (Connecting SCU Harnesses)*	See List <sup>2</sup>
18	2	Prop Light Extension Harness*	See List <sup>8</sup>

Ref #	Qty	Description	Part Number
19	1	Main Bus Harness (Remote Control to GPS Antenna)*	See List <sup>1</sup>
20	1	Pigtail Harness (1FT & 2FT only)*	See List <sup>2</sup>
	1	Main Bus Harness (Multi-Hub to Remote Control)*	See List <sup>1</sup>
	1	Pigtail Harness (Multi-Hub to Display)*	See List <sup>2</sup>

	1	Gauge Kit*	
21		MFD Interface Type 1	6YM-8A2D0-11-00
	1	MFD Interface Install Kit*	MAR-CLOD1-KT-00
22		Fuel Tank Wire	6YM-8356N-00-00
23		Multi-Hub	6Y8-81920-01-00
24		Conversion Harness	6Y9-83553-00-00
25		Main Bus Wire	See List <sup>1</sup>
26		Pigtail Bus Wire	See List <sup>2</sup>
27		System Power Supply Wire	6Y8-83553-02-00
28		4-Pin Waterproof Cap	6Y8-82582-11-00
29		CL0 Conversion Harness	6YM-83553-10-00

30	1	Joystick Controller Assembly*	6X9-482A0-02-00 (Chrome)
or	1	Joystick Controller Assembly*	6X9-482A0-10-00 (Black)
31	2	Prop Light LED Assembly (Transom)*	6ES-83720-03-00
OR	2	Prop Light LED Assembly (On Engine)*	6KN-762A0-00-00

		Gray on Engine Prop Light Cover 4.2L*	6KA-42723-10-8D
		White on Engine Prop Light Cover 4.2L*	6KA-42723-10-CE
		Gray on Engine Prop Light Cover 2.8L*	6LH-42723-10-8D
		White on Engine Prop Light Cover 2.8L*	6LH-42723-10-CE

## Twin Engine Second Station Full Maneuverability

## Helm Master® EX

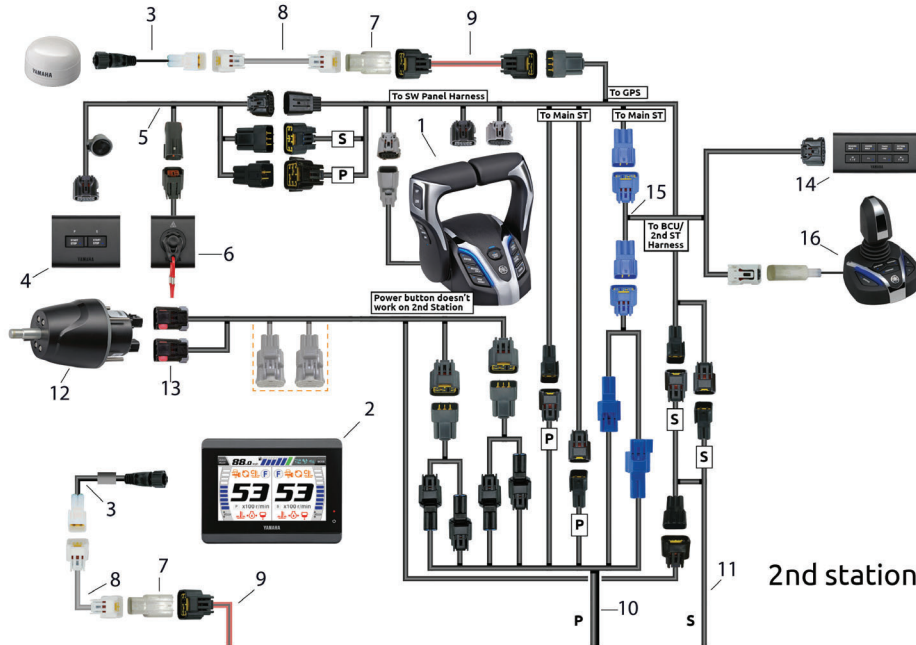

\* Additional for 2nd Station XTO 425 only - Single engines and P and S only for multi engine configs



### Parts order list for basic installation:

#### Level 1

Ref #	Qty	Description	Part Number
1	1	6x9 Twin DEC	6X9-48207-30-00
	1	Gauge Kit	MAR-CL5DU-KT-00
2	1	CL5 Display	6YM-83710-17-00
3	1	Conversion Harness	6YM-83553-00-00
	1	EKS Kit	6X9-762E0-91-00
4	1	Individual Start/Stop SW	6X9-82570-32-00
5	1	EKS Harness	6X9-82716-71-00
6	1	Emergency Stop SW	6X9-82570-81-00
	1	Rigging components needed	
7	1	Single-Hub	6Y8-81920-11-00
8	1	Pigtail Bus Wire	See List <sup>1</sup>
9	1	Main bus Wire	See List <sup>2</sup>
10	1	2nd Helm harness (Port)	See List <sup>3</sup>
11	1	2nd Helm harness (Stbd)	See List <sup>4</sup>

#### Level 2

Ref #	Qty	Description	Part Number
	1	Helm and Tilt Kit	6GR-762H0-11-00
	1	Helm Unit Assembly	6GR-615A0-11-00
	1	Tilt Helm Unit	6GR-615A4-01-00
12	1	Helm Unit Assembly	6X9-762H0-10-00*
13	1	Helm Harness (2nd station)	6X9-8258A-B1-00*

\*\*Additional for 2nd Station XTO only.  
6GR-8258A-V0-00 X2

#### Level 3

Ref #	Qty	Description	Part Number
	1	Autopilot Kit	6X9-762P0-12-00
14	1	Autopilot Panel	6X9-8253V-02-00
15	1	BCU Harness	6X9-82386-10-00
	1	BCU Harness Extension	See List <sup>5</sup>

#### Level 4

Ref #	Qty	Description	Part Number
16	1	Joystick Controller Assy	6X9-482A0-02-00 (Chrome)

1Pigtail Bus Wire	
1 ft.	6Y8-82521-01-00
2 ft.	6Y8-82521-11-00
3 ft.	6Y8-82521-21-00
6 ft.	6Y8-82521-31-00
9 ft.	6Y8-82521-41-00
12 ft.	6Y8-82521-51-00
2Main Bus Wire	
1 ft.	6Y8-82553-01-00
10 ft.	6Y8-82553-50-00
15 ft.	6Y8-82553-11-00
20 ft.	6Y8-82553-21-00
25 ft.	6Y8-82553-31-00
30 ft.	6Y8-82553-41-00

32nd Helm Harness (Port)	
16 ft.	6X9-8258A-01-00
26 ft.	6X9-8258A-11-00
38 ft.	6X9-8258A-21-00
42nd Helm Harness (Starboard)	
16 ft.	6X9-8258A-31-00
26 ft.	6X9-8258A-41-00
38 ft.	6X9-8258A-51-00
5BCU Extension Harness	
15 ft.	6X9-82521-00-00
30 ft.	6X9-82521-10-00

# Rigging Estimate Guide

## Triple Engine Single Station Level 2 EKS

## Helm Master® EX

<b>TRIPLE</b> ENGINE	<b>6X9</b> TOP MOUNT	<b>CL5</b> DISPLAY	<b>EKS</b> SWITCH	<b>DES</b> INTEGRATED	<b>SINGLE</b> STATION
-------------------------	-------------------------	-----------------------	----------------------	--------------------------	--------------------------

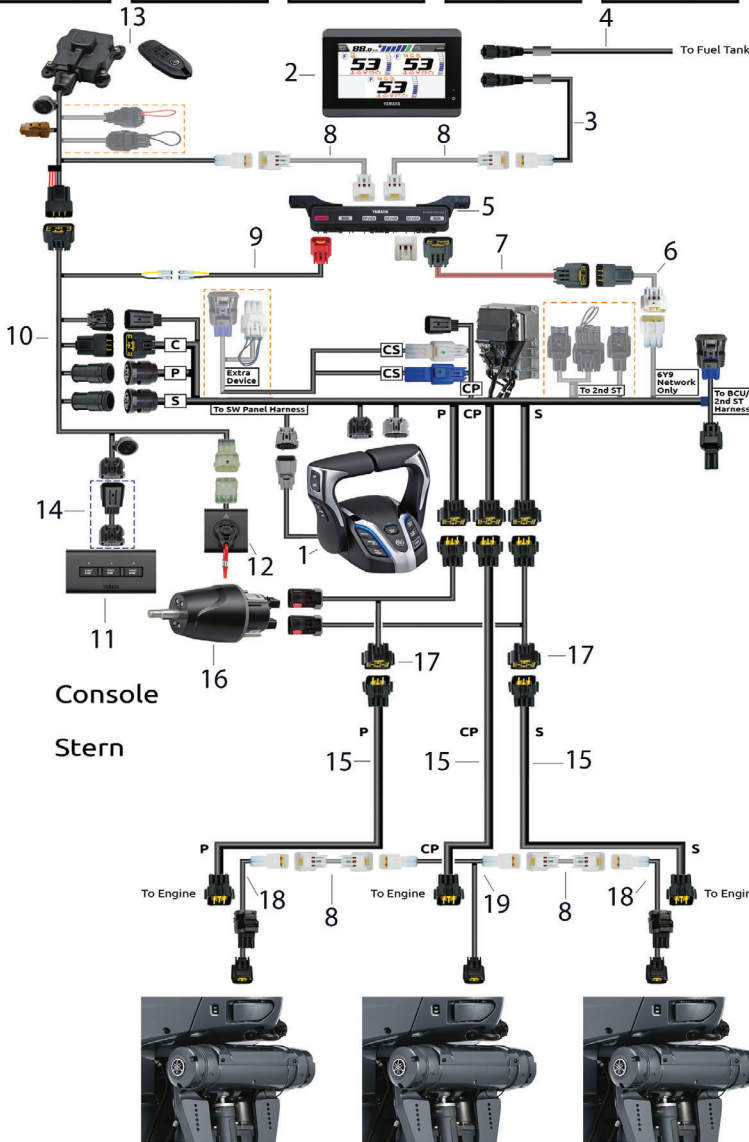

1 Main Bus Wire	
1 ft.	6Y8-82553-01-00
10 ft.	6Y8-82553-50-00
15 ft.	6Y8-82553-11-00
20 ft.	6Y8-82553-21-00
25 ft.	6Y8-82553-31-00
30 ft.	6Y8-82553-41-00
2 Pigtail Bus Wire	
1 ft.	6Y8-82521-01-00
2 ft.	6Y8-82521-11-00
3 ft.	6Y8-82521-21-00
6 ft.	6Y8-82521-31-00
9 ft.	6Y8-82521-41-00
12 ft.	6Y8-82521-51-00
3 Steering Actuator Harness	
8 ft.	6X9-438A0-01-00
15 ft.	6X9-438A0-11-00
4 Main-Harness (16P)	
5 ft.	6X6-8258A-91-00
12 ft.	6X6-8258A-51-00
17 ft.	6X6-8258A-61-00
19 ft.	6X6-8258A-01-00
23 ft.	6X6-8258A-11-00
26 ft.	6X6-8258A-21-00
32 ft.	6X6-8258A-31-00
39 ft.	6X6-8258A-41-00
49 ft.	6X6-8258A-71-00
79 ft.	6X6-8258A-81-00
5 Helm Harness (Main/Multi)	
3 ft.	6GR-8258A-11-00
6 ft.	6GR-8258A-51-00
9 ft.	6GR-8258A-61-00
6 SCU Link Harness (Port/Stbd)	
1 ft.	6X9-81115-00-00
5 ft.	6GR-81115-00-00
10 ft.	6GR-81115-10-00
7 SCU Link Harness (Center)	
1 ft.	6X9-81115-10-00
5 ft.	6GR-81115-20-00
10 ft.	6GR-81115-30-00
8 EKS Extension Harness	
15 ft.	6X9-82586-00-00
30 ft.	6X9-82586-10-00

### Parts order list for basic installation:

Ref #	Qty	Description	Part Number
1	1	6X9 Triple DEC	6X9-48208-11-00
	1	Gauge Kit	MAR-CL5DU-KT-00
2	1	CL5 Display	6YM-83710-17-00
3	1	Conversion Harness	6YM-83553-00-00
	1	CL7/CL5 Install Kit	MAR-CL7D1-KT-30
4	1	Fuel Tank Wire	6YD-8356N-00-00
5	1	Multi-Hub	6Y8-81920-01-00
6	1	Conversion Harness	6Y9-83553-00-00
7	1	Main Bus Wire	See List <sup>1</sup>
8	1	Pigtail Bus Wire	See List <sup>2</sup>
9	1	System Power Supply Wire	6Y8-83553-02-00
	2	4-Pin Waterproof Cap	6Y8-82582-11-00
	1	EKS Kit*	6X9-762E0-62-00

Ref #	Qty	Description	Part Number
10	1	EKS Harness	6X9-82716-41-00
11	1	Individual Start/Stop Switch	6X9-82570-42-00
12	1	Emergency Stop Switch	6X9-82570-C1-00
13	1	Key Fob and Receiver Assembly	6X9-762D0-15-00
14	1	EKS Extension Harness	See List <sup>8</sup>
15	2	Main-Harness (16P)	See List <sup>4</sup>
	1	Helm and Tilt Kit	6GR-762H0-11-00
	1	Helm Unit Assembly	6GR-615A0-11-00
	1	Tilt Helm Unit	6GR-6154A-01-00
16	1	Helm Unit Assembly	6X9-762H0-10-00
17	2	Helm Harness (Main/Multi)	See List <sup>5</sup>
18	2	SCU Link Harness (Port/Stbd)	See List <sup>6</sup>
19	1	SCU Link Harness (Center)	See List <sup>7</sup>

\*Please Refer to Parts Manager Pro for all EKS Kit components.

## Triple Engine Single Station Level 2 6X6

## Helm Master® EX

<b>TRIPLE</b> ENGINE	<b>6X9</b> TOP MOUNT	<b>CL5</b> DISPLAY	<b>STD</b> SWITCH	<b>DES</b> BOLT ON	<b>SINGLE</b> STATION
-------------------------	-------------------------	-----------------------	----------------------	-----------------------	--------------------------

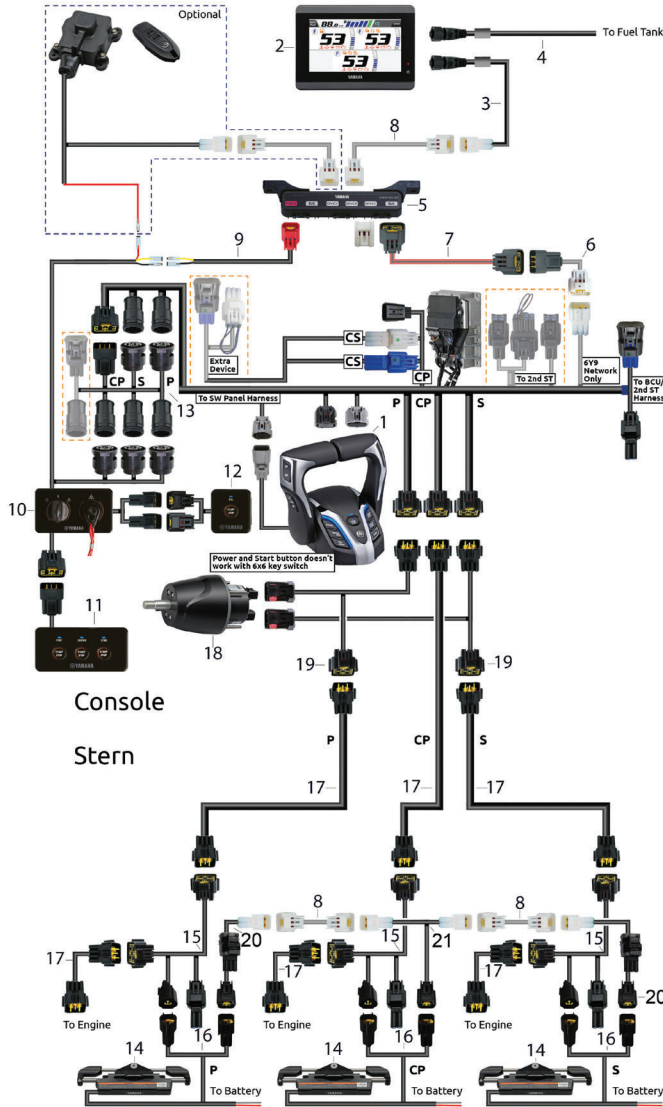

<b>1 Main Bus Wire</b>	
1 ft.	6Y8-82553-01-00
10 ft.	6Y8-82553-50-00
15 ft.	6Y8-82553-11-00
20 ft.	6Y8-82553-21-00
25 ft.	6Y8-82553-31-00
30 ft.	6Y8-82553-41-00
<b>2 Pigtail Bus Wire</b>	
1 ft.	6Y8-82521-01-00
2 ft.	6Y8-82521-11-00
3 ft.	6Y8-82521-21-00
6 ft.	6Y8-82521-31-00
9 ft.	6Y8-82521-41-00
12 ft.	6Y8-82521-51-00
<b>3 Steering Actuator Harness</b>	
8 ft.	6X9-438A0-01-00
15 ft.	6X9-438A0-11-00
<b>4 Main-Harness (16P)</b>	
5 ft.	6X6-8258A-91-00
12 ft.	6X6-8258A-51-00
17 ft.	6X6-8258A-61-00
19 ft.	6X6-8258A-01-00
23 ft.	6X6-8258A-11-00
26 ft.	6X6-8258A-21-00
32 ft.	6X6-8258A-31-00
39 ft.	6X6-8258A-41-00
49 ft.	6X6-8258A-71-00
79 ft.	6X6-8258A-81-00
<b>5 Helm Harness (Main/Multi)</b>	
3 ft.	6GR-8258A-11-00
6 ft.	6GR-8258A-51-00
9 ft.	6GR-8258A-61-00
<b>6 SCU Link Harness (Port/Stbd)</b>	
1 ft.	6X9-81115-00-00
5 ft.	6GR-81115-00-00
10 ft.	6GR-81115-10-00
<b>7 SCU Link Harness (Center)</b>	
1 ft.	6X9-81115-10-00
5 ft.	6GR-81115-20-00
10 ft.	6GR-81115-30-00

### Parts order list for basic installation:

Ref #	Qty	Description	Part Number
1	1	6x9 Triple DEC	6X9-48208-11-00
	1	Gauge Kit	MAR-CL5DU-KT-00
2	1	CL5 Display	6YM-83710-17-00
3	1	Conversion Harness	6YM-83553-00-00
	1	CL7/CL5 Install Kit	MAR-CL7D1-KT-30
4	1	Fuel Tank Wire	6YD-8356N-00-00
5	1	Multi-Hub	6Y8-81920-01-00
6	1	Conversion Harness	6Y9-83553-00-00
7	1	Main Bus Wire	See List <sup>1</sup>
8	1	Pigtail Bus Wire	See List <sup>2</sup>
9	1	System Power Supply Wire	6Y8-83553-02-00
	2	4-Pin Waterproof Cap	6Y8-82582-11-00
	1	Switch Kit	6X6-762B0-11-00
10	1	Main Switch	6X6-82570-51-00
11	1	Triple Start/Stop Switch	6X6-82570-70-00

Ref #	Qty	Description	Part Number
12	1	All Start/Stop Switch	6X6-82570-D0-00
13	1	6x6 to 6x9 Conversion Harness	6X9-83553-60-00
	3	Steering Kit	6X9-762S0-03-00
14	3	Bolt-on Steering Actuator	6X9-42401-11-00
15	3	Split Harness	6X9-8258A-90-00
16	3	Steering Actuator Harness	See List <sup>3</sup>
17	3	Main-Harness (16P)	See List <sup>4</sup>
	1	Helm and Tilt Kit	6GR-762H0-11-00
	1	Helm Unit Assembly	6GR-615A0-11-00
	1	Tilt Helm Unit	6GR-615A4-01-00
18	1	Helm Unit Assembly	6X9-762H0-10-00
19	2	Helm Harness (Main/Multi)	See List <sup>5</sup>
20	2	SCU Link Harness (Port/Stbd)	See List <sup>6</sup>
21	1	SCU Link Harness (Center)	See List <sup>7</sup>



## Triple Engine Maneuverability Kit for Built In Electric Steering

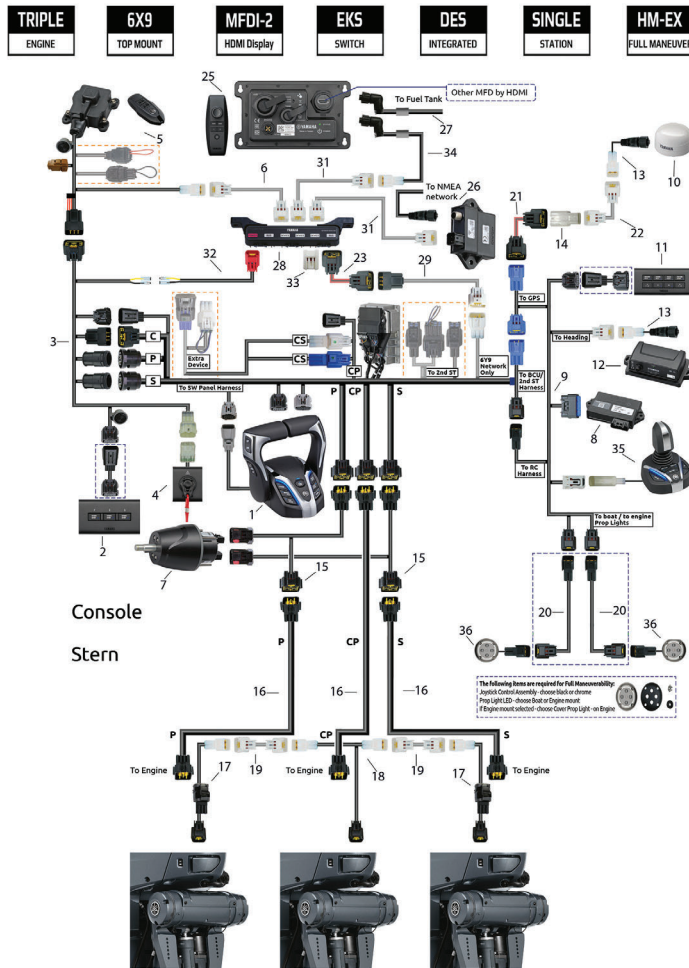

## Helm Master® EX

1 Main Bus Wire	
1 ft.	6Y8-82553-01-00
10 ft.	6Y8-82553-50-00
15 ft.	6Y8-82553-11-00
20 ft.	6Y8-82553-21-00
25 ft.	6Y8-82553-31-00
30 ft.	6Y8-82553-41-00
2 Pigtail Bus Wire	
1 ft.	6Y8-82521-01-00
2 ft.	6Y8-82521-11-00
3 ft.	6Y8-82521-21-00
6 ft.	6Y8-82521-31-00
9 ft.	6Y8-82521-41-00
12 ft.	6Y8-82521-51-00
3 Main-Harness (16P)	
5 ft.	6X6-8258A-91-00
12 ft.	6X6-8258A-51-00
17 ft.	6X6-8258A-61-00
19 ft.	6X6-8258A-01-00
23 ft.	6X6-8258A-11-00
26 ft.	6X6-8258A-21-00
32 ft.	6X6-8258A-31-00
39 ft.	6X6-8258A-41-00
49 ft.	6X6-8258A-71-00
79 ft.	6X6-8258A-81-00
4 Helm Harness (Main/Multi)	
3 ft.	6GR-8258A-11-00
6 ft.	6GR-8258A-51-00
9 ft.	6GR-8258A-61-00
5 SCU Link Harness (Port/Stbd)	
1 ft.	6X9-81115-00-00
5 ft.	6GR-81115-00-00
10 ft.	6GR-81115-10-00
6 SCU Link Harness (Center)	
1 ft.	6X9-81115-10-00
5 ft.	6GR-81115-20-00
10 ft.	6GR-81115-30-00
7 BCU Extension Harness	
15 ft.	6X9-82521-00-00
30 ft.	6X9-82521-10-00
8 Prop Light Extension Harness	
20 ft.	6X9-82586-20-00
30 ft.	6X9-82586-30-00
40 ft.	6X9-82586-40-00

### Parts order list for basic installation:

Ref #	Qty	Description	Part Number
		Triple Engine Maneuverability Kit	MAR-HMEX3-XT-10
1	1	DEC Triple Main Station	6X9-48208-11-00
	1	Electronic Key Switch	6X9-762E0-61-00
2		Individual Start/Stop SW	6X9-82570-42-00
3		EKS Harness	6X9-82716-41-00
4		Engine Shut-off Switch	6X9-82570-C1-00
5		Key Fob and Receiver Assy	6X9-762D0-15-00
6		2ft Pigtail	6Y8-82521-11-00
	1	Helm Components	6GR-762H0-11-00
7		Helm Unit Assembly	6GR-615A0-11-00
Not Shown		Tilt Helm Unit	6GR-615A4-01-00
		Tilt Helm Instruction Manual	6GR-2819K-L1-00
		Maneuverability Components	
8	1	Boat Control Unit- Triple	6X9-8591T-35-00
9	1	Boat Control Unit Harness	6X9-82386-02-00
10	1	GPS Unit	6X9-88107-02-00
11	1	Autopilot Control Panel Assembly	6X9-8253V-02-00
12	1	Heading Sensor Unit	6X9-8A410-02-00
13	2	Wire Lead	6YM-83553-00-00
14	1	In-Line Hub Assembly	6Y8-81920-11-00

Not Included in the Triple Maneuverability Kit After this point*		
15	2	Helm Harness (Main/Multi Engine)* See List <sup>4</sup>
16	3	Main Harness (16P) (Remote Control to Engine)* See List <sup>3</sup>
17	2	SCU Link P/S* See List <sup>5</sup>
18	1	SCU Link C* See List <sup>6</sup>
19	2	Pigtail Harness (connecting SCU Harnesses)* See List <sup>2</sup>
20	2	Prop Light Extension Harness* See List <sup>8</sup>

Ref #	Qty	Description	Part Number
21	1	Main Bus Harness (Remote Control to GPS Antenna)*	See List <sup>1</sup>
22	1	Pigtail Harness (1FT & 2FT only)*	See List <sup>2</sup>
23	1	Main Bus Harness (Multi-Hub to Remote Control)*	See List <sup>1</sup>
24	1	Pigtail Harness (Multi-Hub to Display)*	See List <sup>2</sup>

	1	Gauge Kit*	MAR-CL000-KT-00
25		MFD Interface Type 2	6YM-8A201-01-00
		HDMI Cable	6YM-8533A-00-00
26		Gateway NMEA 2000 Wire	6Y8-82521-00-00
	1	MFD Interface Install Kit*	MAR-CL0D1-KT-00
27		Fuel Tank Wire	6YM-8356N-00-00
28		Multi-Hub	6Y8-81920-01-00
29		Conversion Harness	6Y9-83553-00-00
30		Main Bus Wire	See List <sup>1</sup>
31		Pigtail Bus Wire	See List <sup>2</sup>
32		System Power Supply Wire	6Y8-83553-02-00
33		4-Pin Waterproof Cap	6Y8-82582-11-00
34		CL0 Conversion Harness	6YM-83553-10-00

35	1	Joystick Controller Assembly*	6X9-482A0-02-00 (Chrome)
or	1	Joystick Controller Assembly*	6X9-482A0-10-00 (Black)
36	2	Prop Light LED Assembly (Transom)*	6ES-83720-03-00
OR	2	Prop Light LED Assembly (On Engine)*	6KN-762A0-00-00

		Gray on Engine Prop Light Cover 4.2L*	6KA-42723-10-8D
		White on Engine Prop Light Cover 4.2L*	6KA-42723-10-CE
		Gray on Engine Prop Light Cover 2.8L*	6LH-42723-10-8D
		White on Engine Prop Light Cover 2.8L*	6LH-42723-10-CE

## Triple Engine Second Station Full Maneuverability

## Helm Master® EX

<b>TRIPLE</b> ENGINE	<b>6X9</b> TOP MOUNT	<b>CL5</b> DISPLAY	<b>EKS</b> SWITCH	<b>SECOND</b> STATION	<b>HM-EX</b> FULL MANEUVER
-------------------------	-------------------------	-----------------------	----------------------	--------------------------	-------------------------------

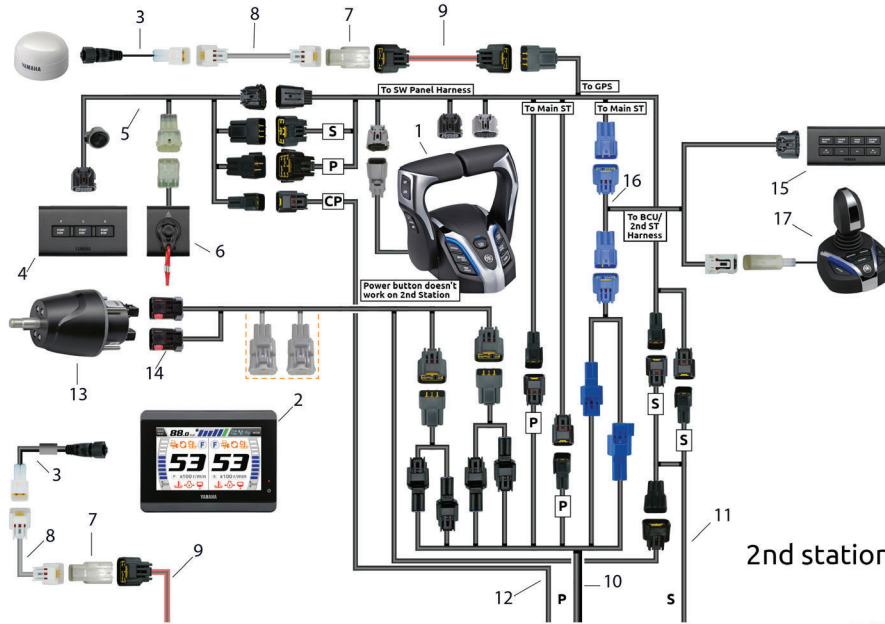

\* Additional for 2nd Station XTO 425 only - Single engines and P and S only for multi engine configs



### Parts order list for basic installation:

#### Level 1

Ref #	Qty	Description	Part Number
1	1	6x9 Triple DEC	6X9-48207-30-00
	1	Gauge Kit	MAR-CL5DU-KT-00
2	1	CL5 Display	6YM-83710-17-00
3	1	Conversion Harness	6YM-83553-00-00
	1	EKS Kit	6X9-762B0-A1-00
4	1	Individual Start/Stop SW	6X9-82570-42-00
5	1	EKS harness	6X9-82716-80-00
6	1	Emergency Stop SW	6X9-82570-C1-00
	1	Rigging Components	
7	2	Single-Hub	6Y8-81920-11-00
8	2	Pigtail Bus Wire	See List <sup>1</sup>
9	2	Main Bus Wire	See List <sup>2</sup>
10	1	2nd Helm Harness (Port)	See List <sup>3</sup>
11	1	2nd Helm Harness (Stbd)	See List <sup>4</sup>
12	1	2nd Helm Harness (Center)	See List <sup>5</sup>

#### Level 2

Ref #	Qty	Description	Part Number
	1	Helm and Tilt Kit	6GR-762H0-11-00
	1	Helm Unit Assembly	6GR-615A0-11-00
	1	Tilt Helm Unit	6GR-6154A-01-00
13	1	Helm Unit Assembly	6X9-762H0-10-00
14	1	Helm Harness (2nd Station)	6X9-8258A-B1-00

\*\*Additional for 2nd Station XTO only.  
6GR-8258A-V0-00 X3

#### Level 3

Ref #	Qty	Description	Part Number
	1	Autopilot Kit	6X9-762P0-12-00
15	1	Autopilot Panel	6X9-8253V-02-00
16	1	BCU harness	6X9-82386-10-00
	1	BCU harness extension	See List <sup>6</sup>

#### Level 4

Ref #	Qty	Description	Part Number
17	1	Joystick Controller Assembly	6X9-482A0-02-00 (Chrome)

#### <sup>1</sup>Pigtail Bus Wire

1 ft.	6Y8-82521-01-00
2 ft.	6Y8-82521-11-00
3 ft.	6Y8-82521-21-00
6 ft.	6Y8-82521-31-00
9 ft.	6Y8-82521-41-00
12 ft.	6Y8-82521-51-00

#### <sup>2</sup>Main Bus Wire

1 ft.	6Y8-82553-01-00
10 ft.	6Y8-82553-50-00
15 ft.	6Y8-82553-11-00
20 ft.	6Y8-82553-21-00
25 ft.	6Y8-82553-31-00
30 ft.	6Y8-82553-41-00

#### <sup>3</sup>2nd Helm Harness (Port)

16 ft.	6X9-8258A-01-00
26 ft.	6X9-8258A-11-00
38 ft.	6X9-8258A-21-00

#### <sup>4</sup>2nd Helm Harness (Starboard)

16 ft.	6X9-8258A-31-00
26 ft.	6X9-8258A-41-00
38 ft.	6X9-8258A-51-00

#### <sup>5</sup>2nd Helm Harness (Center)

16 ft.	6X9-8258A-60-00
26 ft.	6X9-8258A-70-00
38 ft.	6X9-8258A-80-00

#### <sup>6</sup>BCU Extension Harness

15 ft.	6X9-82521-00-00
30 ft.	6X9-82521-10-00

# Rigging Estimate Guide

## Quad Engine Single Station Level 2 EKS

## Helm Master® EX

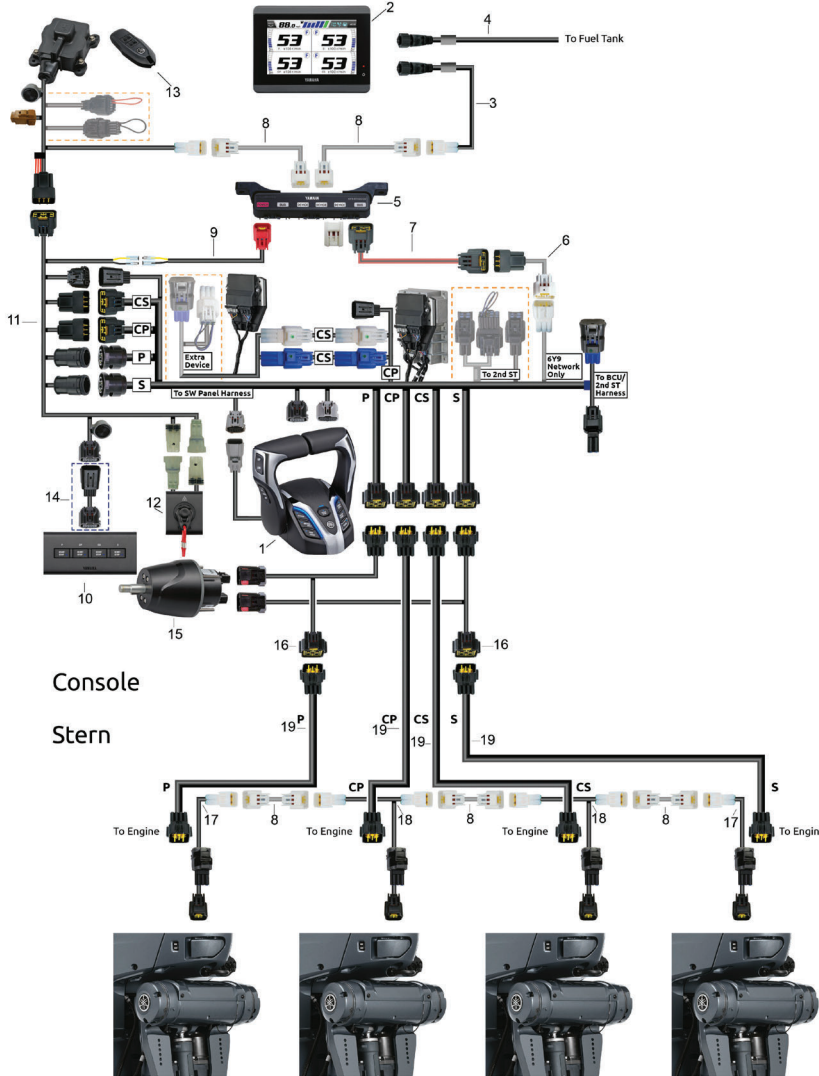

1Main Bus Wire	
1 ft.	6Y8-82553-01-00
10 ft.	6Y8-82553-50-00
15 ft.	6Y8-82553-11-00
20 ft.	6Y8-82553-21-00
25 ft.	6Y8-82553-31-00
30 ft.	6Y8-82553-41-00
2Pigtail Bus Wire	
1 ft.	6Y8-82521-01-00
2 ft.	6Y8-82521-11-00
3 ft.	6Y8-82521-21-00
6 ft.	6Y8-82521-31-00
9 ft.	6Y8-82521-41-00
12 ft.	6Y8-82521-51-00
3Main-Harness (16P)	
5 ft.	6X6-8258A-91-00
12 ft.	6X6-8258A-51-00
17 ft.	6X6-8258A-61-00
19 ft.	6X6-8258A-01-00
23 ft.	6X6-8258A-11-00
26 ft.	6X6-8258A-21-00
32 ft.	6X6-8258A-31-00
39 ft.	6X6-8258A-41-00
49 ft.	6X6-8258A-71-00
79 ft.	6X6-8258A-81-00
4Helm Harness (Main/Multi)	
3 ft.	6GR-8258A-11-00
6 ft.	6GR-8258A-51-00
9 ft.	6GR-8258A-61-00
5SCU Link Harness (Port/Stbd)	
1 ft.	6X9-81115-00-00
5 ft.	6GR-81115-00-00
10 ft.	6GR-81115-10-00
6SCU Link Harness (Center)	
1 ft.	6X9-81115-10-00
5 ft.	6GR-81115-20-00
10 ft.	6GR-81115-30-00
7EKS Extension Harness	
15 ft.	6X9-82586-00-00
30 ft.	6X9-82586-10-00

### Parts order list for basic installation:

Ref #	Qty	Description	Part Number
1	1	6x9 Quad DEC	6X9-48209-11-00
	1	Gauge Kit	MAR-CL5DU-KT-00
2	1	CL5 Display	6YM-83710-17-00
3	1	Conversion Harness	6YM-83553-00-00
	1	CL7/CL5 Install Kit	MAR-CL7D1-KT-30
4	1	Fuel Tank Wire	6YM-8356N-00-00
5	1	Multi-Hub	6Y8-81920-01-00
6	1	Conversion Harness	6Y9-83553-00-00
7	1	Main Bus Wire	See List <sup>1</sup>
8	1	Pigtail Bus Wire	See List <sup>2</sup>
9	1	System Power Supply Wire	6Y8-83553-02-00
	1	4-Pin Waterproof Cap	6Y8-82582-11-00
	1	EKS Kit*	6X9-762E0-72-00
10	1	Individual Start/Stop SW	6X9-82570-52-00
11	1	EKS Harness	6X9-82716-91-00

Ref #	Qty	Description	Part Number
12	1	Emergency Stop SW	6X9-82570-D1-00
13	1	Key Fob and Receiver Assy	6X9-762D0-15-00
14	1	EKS Extension Harness	See List <sup>7</sup>
	1	Pigtail Bus Wire	See List <sup>2</sup>

	1	Helm and Tilt Kit	6GR-762H0-11-00
	1	Helm Unit Assembly	6GR-615A0-11-00
	1	Tilt Helm Unit	6GR-6154A-01-00
15	1	Helm Unit Assembly	6X9-762H0-10-0 <sup>0</sup>
17	2	Helm Harness (Main/Multi)	See List <sup>4</sup>
	3	Pigtail Bus Wire	See List <sup>2</sup>
17	2	SCU Link Harness (Port/Stbd)	See List <sup>5</sup>
18	2	SCU Link Harness (Center)	See List <sup>6</sup>
19	4	Main-Harness (16P)	See List <sup>3</sup>

\*Please Refer to Parts Manager Pro for all EKS Kit components.

## Quad Engine Single Station Level 2 6X6

## Helm Master® EX

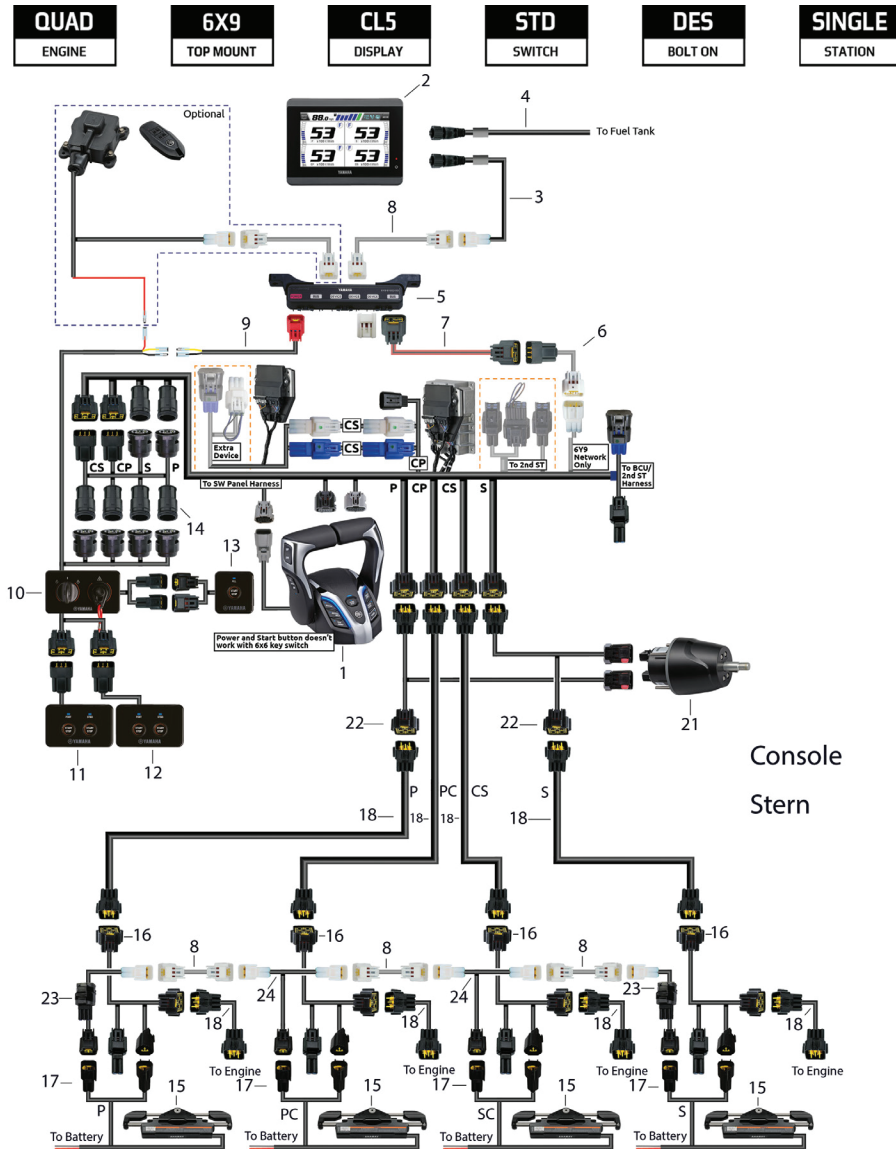

1 Main Bus Wire		
1 ft.	6Y8-82553-01-00	
10 ft.	6Y8-82553-50-00	
15 ft.	6Y8-82553-11-00	
20 ft.	6Y8-82553-21-00	
25 ft.	6Y8-82553-31-00	
30 ft.	6Y8-82553-41-00	
2 Pigtail Bus Wire		
1 ft.	6Y8-82521-01-00	
2 ft.	6Y8-82521-11-00	
3 ft.	6Y8-82521-21-00	
6 ft.	6Y8-82521-31-00	
9 ft.	6Y8-82521-41-00	
12 ft.	6Y8-82521-51-00	
3 Steering Actuator Harness		
8 ft.	6X9-438A0-01-00	
15 ft.	6X9-438A0-11-00	
3 Main-Harness (16P)		
5 ft.	6X6-8258A-91-00	
12 ft.	6X6-8258A-51-00	
17 ft.	6X6-8258A-61-00	
19 ft.	6X6-8258A-01-00	
23 ft.	6X6-8258A-11-00	
26 ft.	6X6-8258A-21-00	
32 ft.	6X6-8258A-31-00	
39 ft.	6X6-8258A-41-00	
49 ft.	6X6-8258A-71-00	
79 ft.	6X6-8258A-81-00	
5 Helm Harness (Main/Multi)		
3 ft.	6GR-8258A-11-00	
6 ft.	6GR-8258A-51-00	
9 ft.	6GR-8258A-61-00	
6 SCU Link Harness (Port/Stbd)		
1 ft.	6X9-81115-00-00	
5 ft.	6GR-81115-00-00	
10 ft.	6GR-81115-10-00	
7 SCU Link Harness (Center)		
1 ft.	6X9-81115-10-00	
5 ft.	6GR-81115-20-00	
10 ft.	6GR-81115-30-00	

### Parts order list for basic installation:

Ref #	Qty	Description	Part Number
1	1	6x9 Quad DEC	6X9-48209-11-00
	1	Gauge Kit	MAR-CL5DU-KT-00
2	1	CL5 Display	6YM-83710-17-00
3	1	Conversion Harness	6YM-83553-00-00
	1	CL7/CL5 Install Kit	MAR-CL7D1-KT-30
4	1	Fuel Tank Wire	6YD-8356N-00-00
5	1	Multi-Hub	6Y8-81920-01-00
6	1	Conversion Harness	6Y9-83553-00-00
7	1	Main Bus Wire	See List <sup>1</sup>
8	1	Pigtail Bus Wire	See List <sup>2</sup>
9	1	System Power Supply Wire	6Y8-83553-02-00
	2	4-pin Waterproof Cap	6Y8-82582-11-00
10	1	Main Switch	6X6-82570-G1-00
11	1	Quad Start/Stop Port	6X6-82570-J0-00
12	1	Quad Start/Stop Stbd	6X6-82570-K0-00

Ref #	Qty	Description	Part Number
13	1	All Start/Stop Switch	6X6-82570-D0-00
14	1	6x6 to 6x9 Conversion Harness	6X9-83553-60-00
15	4	Main-Harness (16P)	See List <sup>3</sup>
	4	Steering Kit	6X9-762S0-03-00
15	4	Bolt-on Actuator	6X9-42401-11-00
16	4	Split Harness	6X9-8258A-90-00
17	4	Steering Actuator Harness	See List <sup>3</sup>
18	4	Main-Harness (16P)	See List <sup>4</sup>
	1	Helm and Tilt Kit	6GR-762H0-11-00
19	1	Helm Unit Assembly	6GR-615A0-11-00
20	1	Tilt Helm Unit	6GR-615A4-01-00
21	1	Helm Unit Assembly	6X9-762H0-10-00
22	2	Helm Harness (Main/Multi)	See List <sup>5</sup>
23	2	SCU Link Harness (Port/Stbd)	See List <sup>6</sup>
24	1	SCU Link Harness (Center)	See List <sup>7</sup>

# Rigging Estimate Guide

## Quad Engine Single Station Full Maneuverability

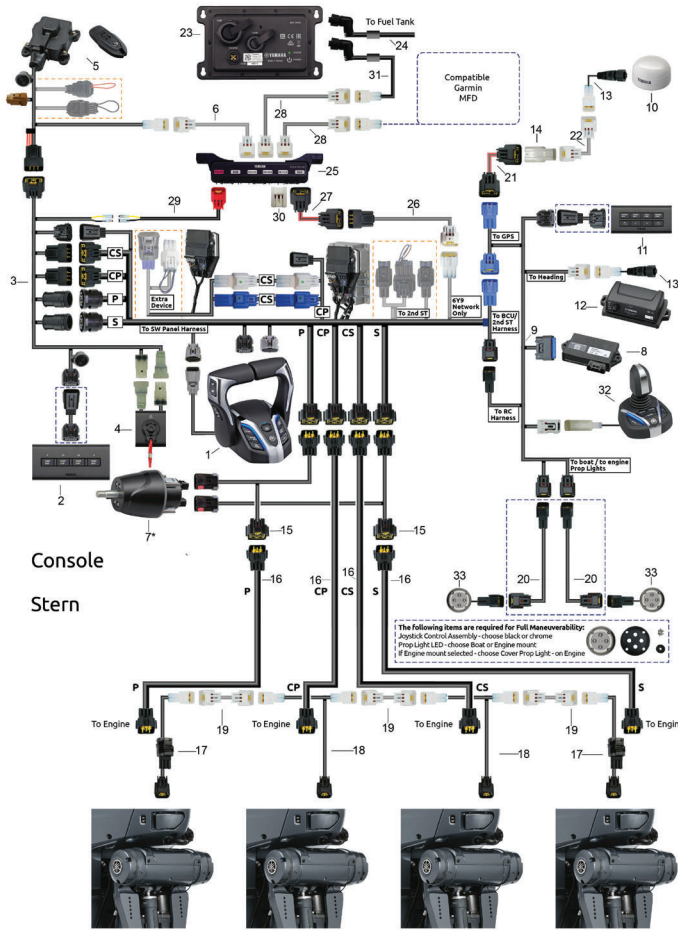

## Helm Master® EX

1 Main Bus Wire	
1 ft.	6Y8-82553-01-00
10 ft.	6Y8-82553-50-00
15 ft.	6Y8-82553-11-00
20 ft.	6Y8-82553-21-00
25 ft.	6Y8-82553-31-00
30 ft.	6Y8-82553-41-00
2 Pigtail Bus Wire	
1 ft.	6Y8-82521-01-00
2 ft.	6Y8-82521-11-00
3 ft.	6Y8-82521-21-00
6 ft.	6Y8-82521-31-00
9 ft.	6Y8-82521-41-00
12 ft.	6Y8-82521-51-00
3 Main-Harness (16P)	
5 ft.	6X6-8258A-91-00
12 ft.	6X6-8258A-51-00
17 ft.	6X6-8258A-61-00
19 ft.	6X6-8258A-01-00
23 ft.	6X6-8258A-11-00
26 ft.	6X6-8258A-21-00
32 ft.	6X6-8258A-31-00
39 ft.	6X6-8258A-41-00
49 ft.	6X6-8258A-71-00
79 ft.	6X6-8258A-81-00
4 Helm Harness (Main/Multi)	
3 ft.	6GR-8258A-11-00
6 ft.	6GR-8258A-51-00
9 ft.	6GR-8258A-61-00
5 SCU Link Harness (Port/Stbd)	
1 ft.	6X9-81115-00-00
5 ft.	6GR-81115-00-00
10 ft.	6GR-81115-10-00
6 SCU Link Harness (Center)	
1 ft.	6X9-81115-10-00
5 ft.	6GR-81115-20-00
10 ft.	6GR-81115-30-00
7 BCU Extension Harness	
15 ft.	6X9-82521-00-00
30 ft.	6X9-82521-10-00
8 Prop Light Extension Harness	
20 ft.	6X9-82586-20-00
30 ft.	6X9-82586-30-00
40 ft.	6X9-82586-40-00

### Parts order list for basic installation:

Ref #	Qty	Description	Part Number
		Quad Engine Maneuverability Kit	MAR-HMEX4-XT-10
1	1	DEC Triple Main Station	6X9-48209-11-00
	1	Electronic Key Switch	6X9-762E0-72-00
2		Individual Start/Stop SW	6X9-82570-52-00
3		EKS Harness	6X9-82716-91-00
4		Emergency Stop SW	6X9-82570-D1-00
5		Key Fob and Receiver Assy	6X9-762D0-15-00
6		2ft Pigtail	6Y8-82521-11-00
	1	Helm Components	6GR-762H0-11-00
Not Shown		Helm Unit Assembly	6GR-615A0-11-00
Not Shown		Tilt Helm Unit	6GR-615A4-01-00
Not Shown		Tilt Helm Instruction Manual	6GR-2819K-L1-00
7		Fixed Helm*	6X9-762H0-10-00
<b>Maneuverability Components</b>			
8	1	Boat Control Unit- Quad	6X9-8591T-45-00
9	1	Boat Control Unit Harness	6X9-82386-02-00
10	1	GPS Unit	6X9-88107-02-00
11	1	Autopilot Control Panel Assembly	6X9-8253V-02-00
12	1	Heading Sensor Unit	6X9-8A410-02-00
13	2	Wire Lead	6YM-83553-00-00
14	1	In-Line Hub Assembly	6Y8-81920-11-00

### Not Included in the Quad Maneuverability Kit After this point\*

15	2	Helm Harness (Main/Multi Engine)*	See List <sup>4</sup>
16	4	Main Harness (16P) (Remote Control to Engine) *	See List <sup>3</sup>
17	2	SCU Link P/S*	See List <sup>5</sup>
18	2	SCU Link C*	See List <sup>6</sup>
19	3	Pigtail Harness (Connecting SCU Harnesses)*	See List <sup>2</sup>

Ref #	Qty	Description	Part Number
20	2	Prop Light Extension Harness*	See List <sup>8</sup>
21	1	Main Bus Wire (Remote Control to GPS Antenna)*	See List <sup>1</sup>
22	1	Pigtail Harness (1FT & 2FT only)*	See List <sup>2</sup>
	1	Main Bus Harness (Multi-Hub to Remote Control)*	See List <sup>1</sup>
	1	Pigtail Harness ( Multi-Hub to Display)*	See List <sup>2</sup>

	1	Gauge Kit*	MAR-CL000-KT-00
23		MFD Interface Type 1	6YM-8A2D0-11-00
	1	MFD Interface Install Kit*	MAR-CL0D1-KT-00
24		Fuel Tank Wire	6YM-8356N-00-00
25		Multi-Hub	6Y8-81920-01-00
26		Conversion Harness	6Y9-83553-00-00
27		Main Bus Wire	See List <sup>1</sup>
28		Pigtail Bus Wire	See List <sup>2</sup>
29		System Power Supply Wire	6Y8-83553-02-00
30		4-Pin Waterproof Cap	6Y8-82582-11-00
31		CL0 Conversion Harness	6YM-83553-10-00

32	1	Joystick controller assembly* (Chrome)	6X9-482A0-02-00
or	1	Joystick controller assembly* (Black)	6X9-482A0-10-00
33	2	Prop Light LED Assembly (Transom)*	6ES-83720-03-00
OR	2	Prop Light LED Assembly (On Engine)*	6KN-762A0-00-00

		Gray on Engine Prop Light Cover 4.2L*	6KA-42723-10-8D
		White on Engine Prop Light Cover 4.2L*	6KA-42723-10-CE
		Gray on Engine Prop Light Cover 2.8L*	6LH-42723-10-8D
		White on Engine Prop Light Cover 2.8L*	6LH-42723-10-CE

## Quad Engine Second Station Full Maneuverability

## Helm Master® EX

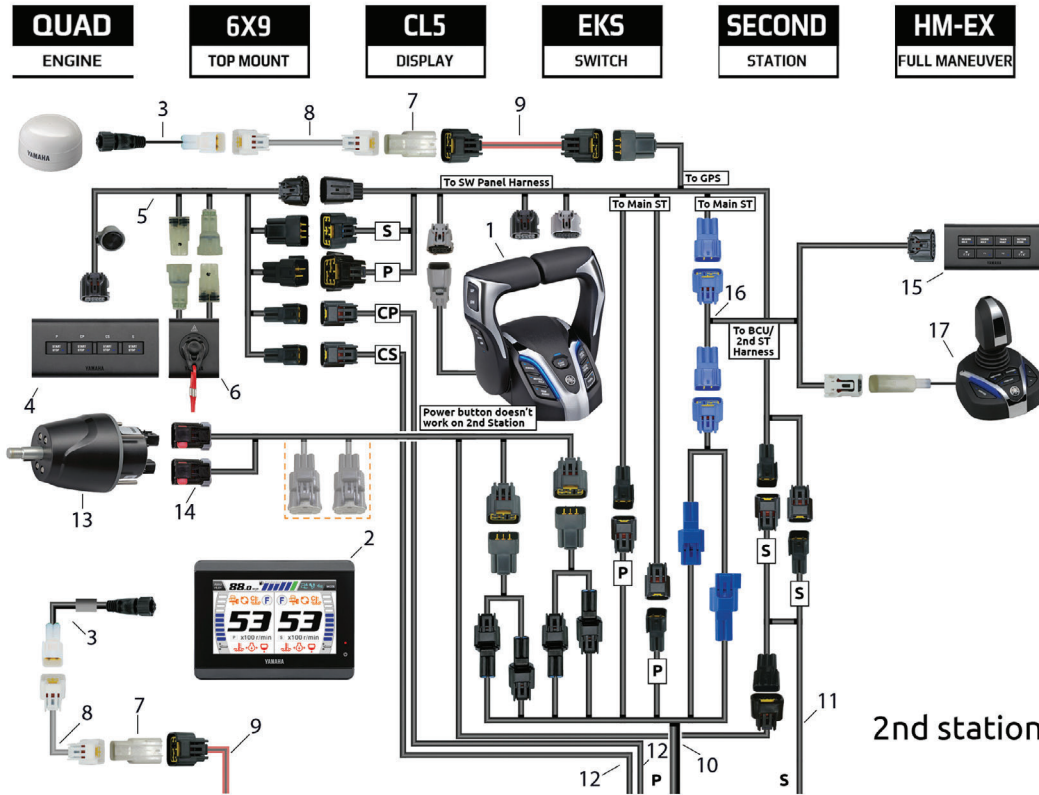

\* Additional for 2nd Station XTO 425 only - Single engines and P and S only for multi engine configs



### Parts order list for basic installation:

#### Level 1

Ref #	Qty	Description	Part Number
1	1	6x9 Quad Dec	6X9-48207-30-00
	1	Gauge Kit	MAR-CL5DU-KT-00
2	1	CL5 Display	6YM-83710-17-00
3	1	Conversion Harness	6YM-83553-00-00
	1	EKS Kit	6X9-762E0-B1-00
4	1	Individual Start/Stop SW	6X9-82570-52-00
5	1	EKS Harness	6X9-82716-A0-00
6	1	Emergency Stop SW	6X9-82570-D1-00
	1	Rigging Components	
7	2	Single-hub	6Y8-81920-11-00
8	2	Pigtail Bus Wire	See List <sup>1</sup>
9	2	Main Bus Wire	See List <sup>2</sup>
10	1	2nd Helm Harness (Port)	See Lis <sup>3</sup>
11	1	2nd Helm Harness (Stbd)	See List <sup>4</sup>
12	2	2nd Helm Harness (Center)	See List <sup>5</sup>

#### Level 2

Ref #	Qty	Description	Part Number
	1	Helm and Tilt Kit	6GR-762H0-11-00
	1	Helm Unit Assembly	6GR-615A0-11-00
	1	Tilt Helm Unit	6GR-6154A-01-00
13	1	Helm Unit Assembly	6X9-762H0-10-00
14	1	Helm Harness (2nd Station)	6X9-8258A-B1-00

#### Level 3

Ref #	Qty	Description	Part Number
	1	Autopilot Kit	6X9-762P0-12-00
15	1	Autopilot Panel	6X9-8253V-02-00
16	1	BCU Harness	6X9-82386-10-00
	1	BCU Harness Extension	See Lis <sup>6</sup>

#### Level 4

Ref #	Qty	Description	Part Number
17	1	Joystick Controller Assy	6X9-482A0-02-00 (Chrome)

<sup>1</sup> Pigtail Bus Wire	
1 ft.	6Y8-82521-01-00
2 ft.	6Y8-82521-11-00
3 ft.	6Y8-82521-21-00
6 ft.	6Y8-82521-31-00
9 ft.	6Y8-82521-41-00
12 ft.	6Y8-82521-51-00
<sup>2</sup> Main Bus Wire	
1 ft.	6Y8-82553-01-00
10 ft.	6Y8-82553-50-00
15 ft.	6Y8-82553-11-00
20 ft.	6Y8-82553-21-00
25 ft.	6Y8-82553-31-00
30 ft.	6Y8-82553-41-00

<sup>3</sup> 2nd Helm Harness (Port)	
16 ft.	6X9-8258A-01-00
26 ft.	6X9-8258A-11-00
38 ft.	6X9-8258A-21-00
<sup>4</sup> 2nd Helm Harness (Starboard)	
16 ft.	6X9-8258A-31-00
26 ft.	6X9-8258A-41-00
38 ft.	6X9-8258A-51-00
<sup>5</sup> 2nd Helm Harness (Center)	
16 ft.	6X9-8258A-60-00
26 ft.	6X9-8258A-70-00
38 ft.	6X9-8258A-80-00
<sup>6</sup> BCU Extension Harness	
15 ft.	6X9-82521-00-00
30 ft.	6X9-82521-10-00

\*\*Additional for 2nd Station XTO only.  
6GR-8258A-V0-00 X4

## Adding a Multi-Hub

If there are no unused “Device Ports” on the Multi-Hubs already installed, before adding additional accessories or gauges to the network another Multi-Hub must be added.



### Parts order list for basic installation:

Quantity	Description	Part Number
1	Multi-Hub	6Y8-81920-01-00
1	Main Bus Harness	See List <sup>1</sup>

1 Main Bus Harnesses	
1 ft.	6Y8-82553-01-00
10 ft.	6Y8-82553-50-00
15 ft.	6Y8-82553-11-00
20 ft.	6Y8-82553-21-00
25 ft.	6Y8-82553-31-00
30 ft.	6Y8-82553-41-00

## Adding a Gateway

Adding a Gateway to the Digital Network requires one open “Device” port. If no open port exists, a Multi-Hub must also be added.

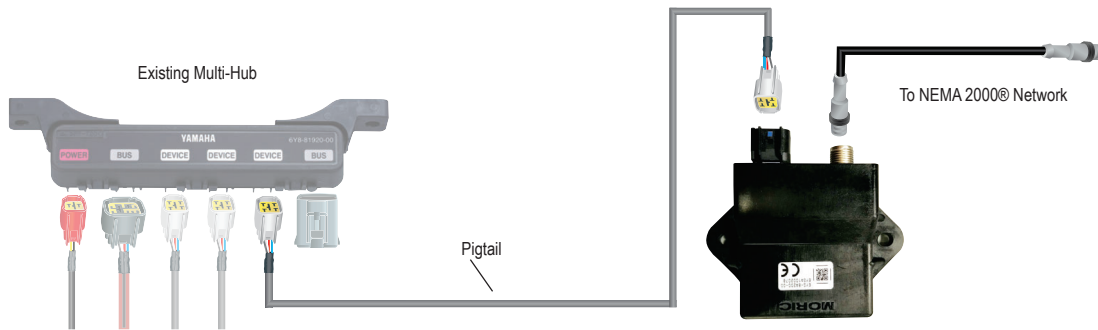

### Parts order list for basic installation:

Quantity	Description	Part Number
1	Command Link® / Command Link Plus® Gateway	MAR-GTWAY-KT-20

Kit includes 2 ft. Pigtail Harness (6Y8-82521-11-00) and NMEA 2000® Wirelead (6YG-82521-00-00)

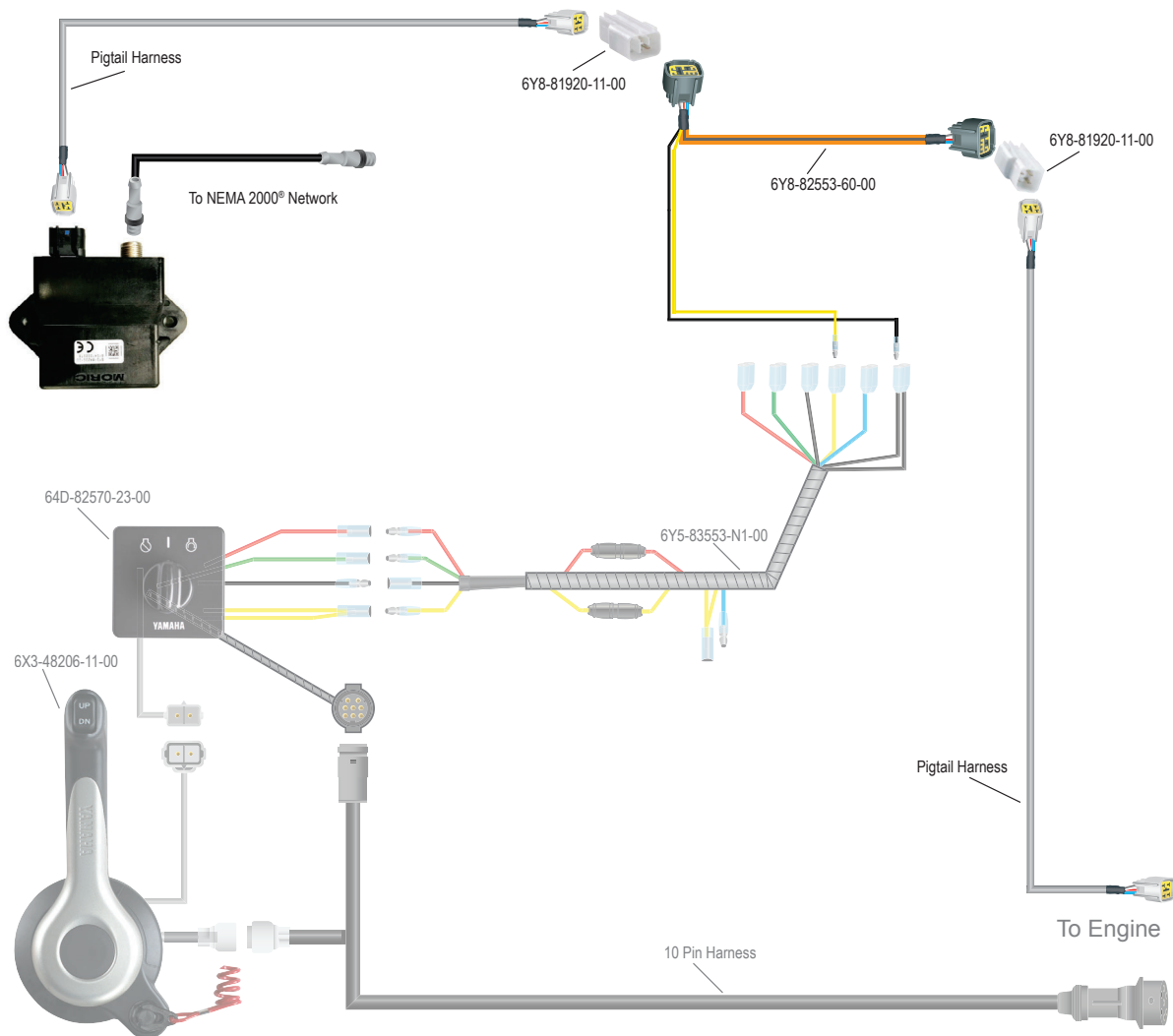

## Parts order list for basic installation:

Quantity	Description	Part Number
1	Command Link® / Command Link Plus® Gateway	MAR-GTWAY-KT-20
2	In-line Hub	6Y8-81920-11-00
1	Orange Extension Harness (14 ft.)	6Y8-82553-60-00
1	Pigtail Harness	See List <sup>1</sup>

*Kit includes 2 ft. Pigtail Harness (6Y8-82521-11-00) and NMEA 2000® Wirelead (6YG-82521-00-00)*

<sup>1</sup> Pigtail Harnesses	
1 ft.	6Y8-82521-01-00
2 ft.	6Y8-82521-11-00
3 ft.	6Y8-82521-21-00
6 ft.	6Y8-82521-31-00
9 ft.	6Y8-82521-41-00
12 ft.	6Y8-82521-51-00



## Adding an AGI (Analog Gauge Interface)

Adding an AGI to the Digital Network requires one open “Device” port. If no open port exists, a Multi-Hub must also be added.



### Parts order list for basic installation:

Quantity	Description	Part Number
1	Command Link® / Command Link Plus® AGI	6YH-8A2D0-02-00
1	Pigtail Harness	See List <sup>1</sup>

<sup>1</sup> Pigtail Harnesses	
1 ft.	6Y8-82521-01-00
2 ft.	6Y8-82521-11-00
3 ft.	6Y8-82521-21-00
6 ft.	6Y8-82521-31-00
9 ft.	6Y8-82521-41-00
12 ft.	6Y8-82521-51-00

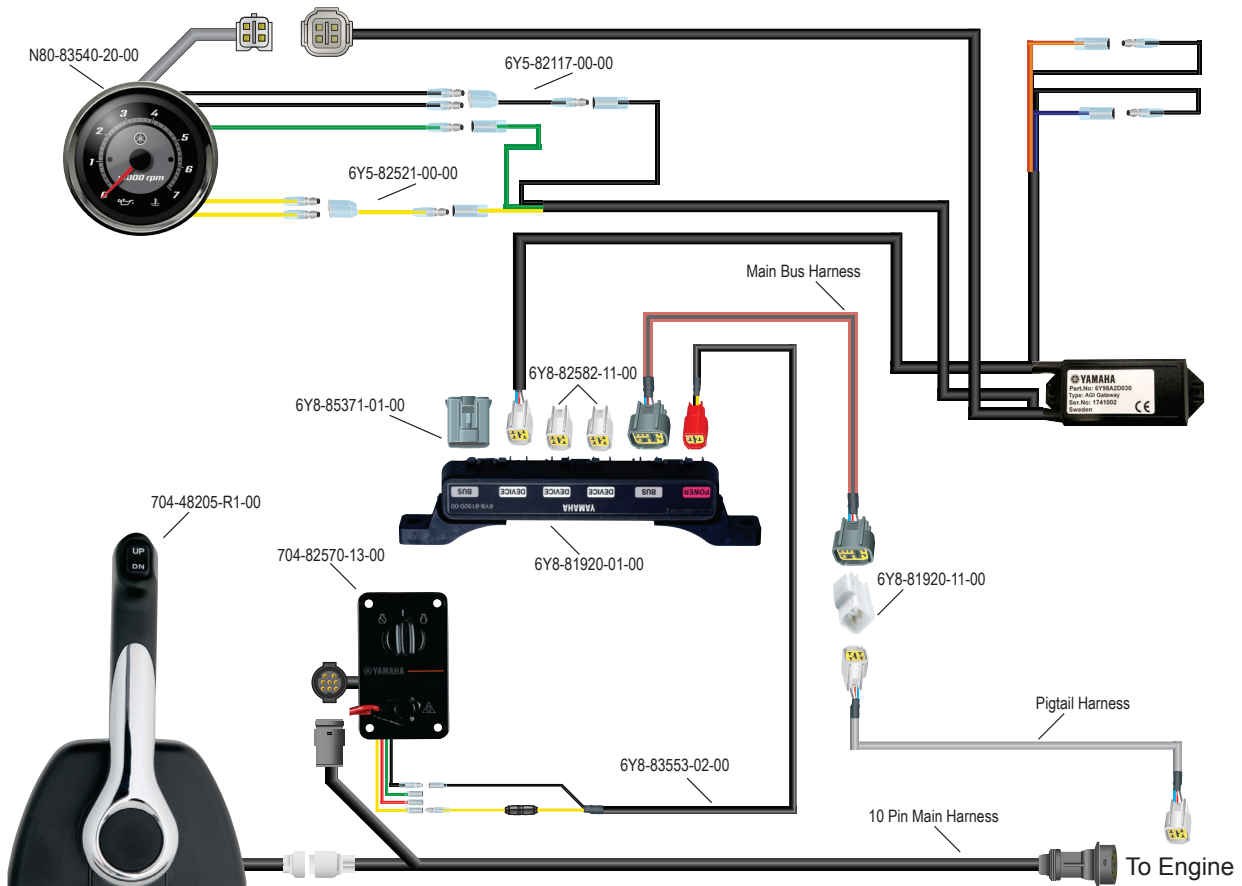

## Adding a Multisensor

Adding a Multisensor to the Digital Network requires one open "BUS" port. If no open port exists, refer to the diagram on the next page (The "Bus" ports maybe come full with a CLP network installed on a second station).

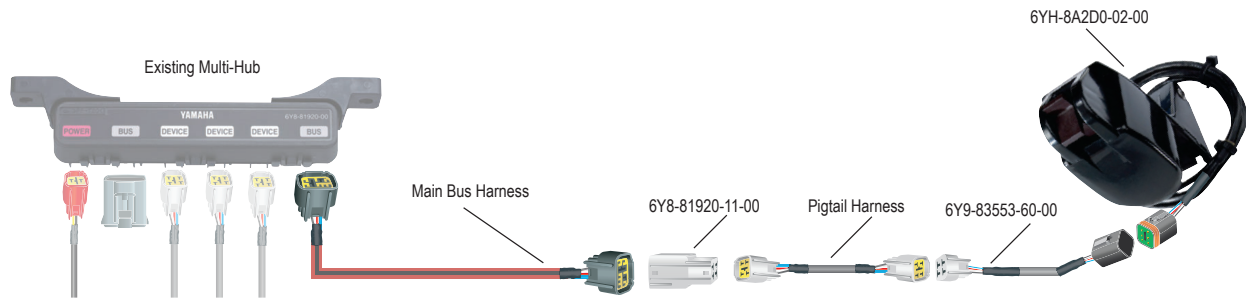

### Parts order list for basic installation:

Quantity	Description	Part Number
1	Command Link Plus® Multisensor Kit	6YH-8A2D0-02-00
1	Main Bus Harness	See List <sup>1</sup>

<sup>1</sup> Main Bus Harnesses	
1 ft.	6Y8-82553-01-00
10 ft.	6Y8-82553-50-00
15 ft.	6Y8-82553-11-00
20 ft.	6Y8-82553-21-00
25 ft.	6Y8-82553-31-00
30 ft.	6Y8-82553-41-00

Adding a Multisensor to the Digital Network requires one open "BUS" port. When no open port exists refer to this diagram.

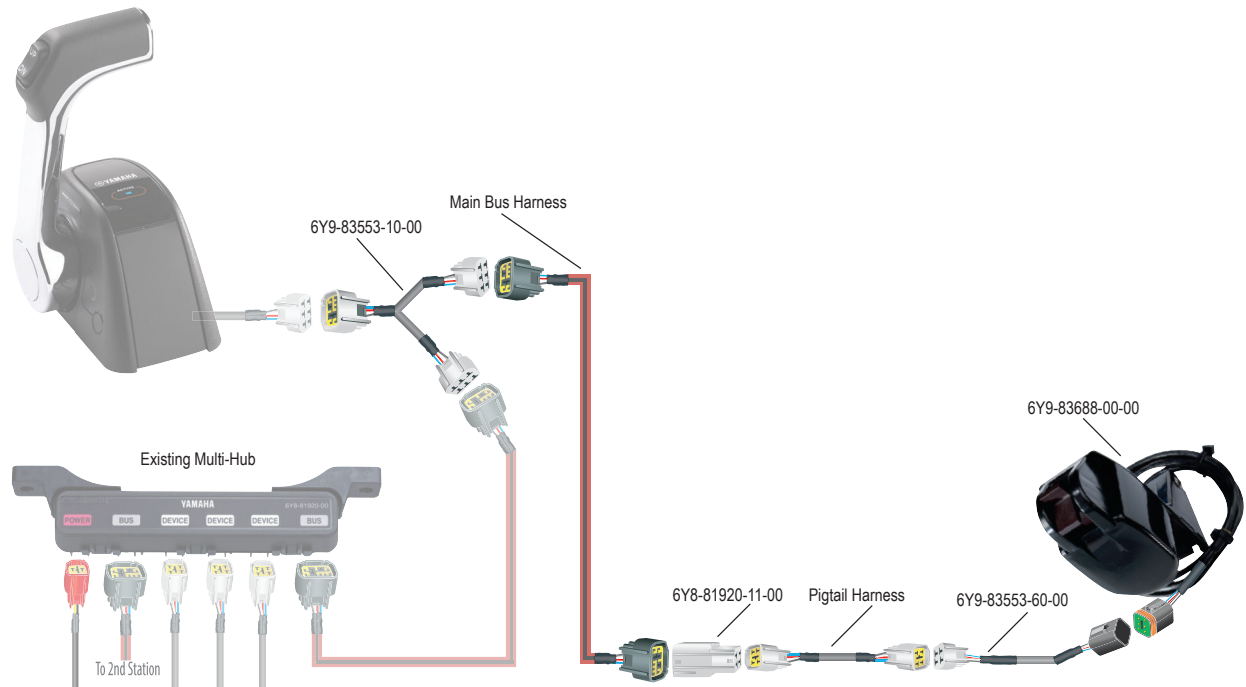

### Parts order list for basic installation:

Quantity	Description	Part Number
1	Command Link Plus® Multisensor Kit	MAR-3DCER-KT-00
1	Command Link Plus® Y Adaptor	6Y9-83553-10-00
1	Main Bus Harness	See List <sup>1</sup>

<sup>1</sup> Main Bus Harnesses	
1 ft.	6Y8-82553-01-00
10 ft.	6Y8-82553-50-00
15 ft.	6Y8-82553-11-00
20 ft.	6Y8-82553-21-00
25 ft.	6Y8-82553-31-00
30 ft.	6Y8-82553-41-00

## Y-COP® Installations

Y-COP® installed with a Single Engine

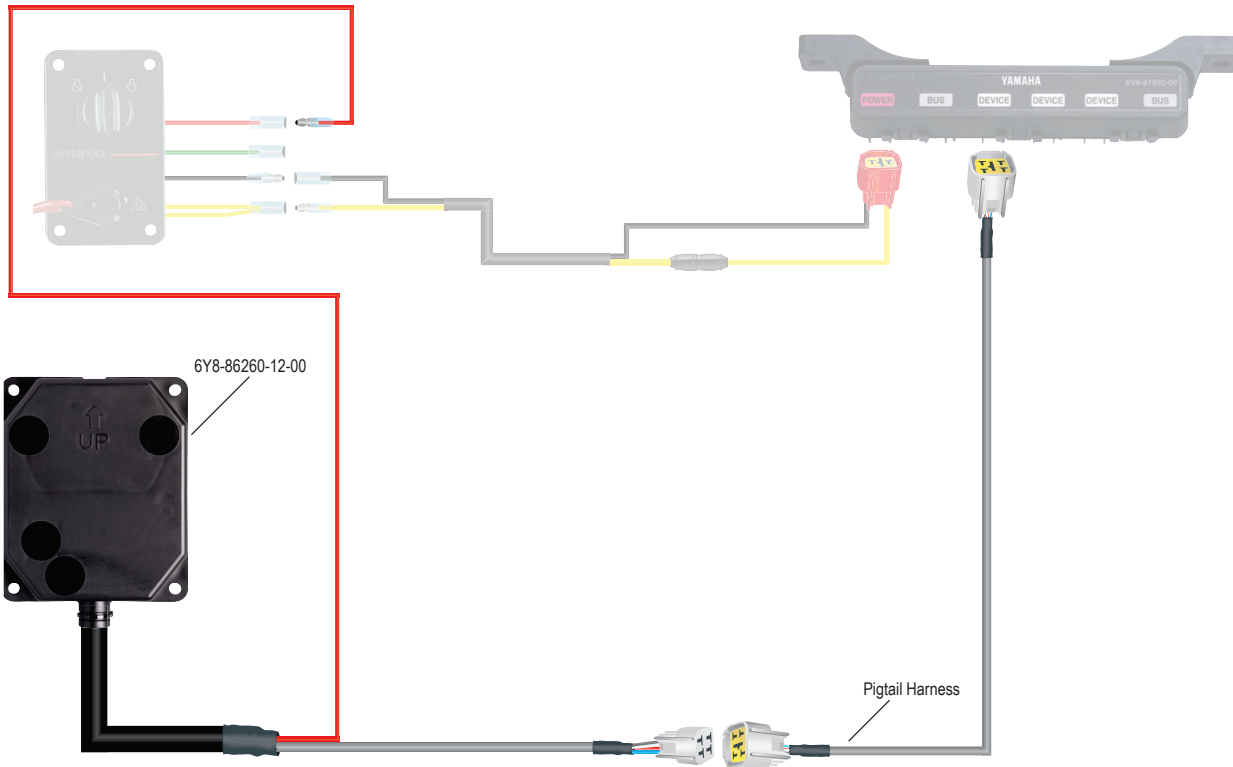

Parts order list for basic installation:

Quantity	Description	Part Number
1	Y-COP® Kit	6Y8-762D0-00-00
1	Pigtail Harness	See List <sup>1</sup>

<sup>1</sup> Pigtail Harnesses	
1 ft.	6Y8-82521-01-00
2 ft.	6Y8-82521-11-00
3 ft.	6Y8-82521-21-00
6 ft.	6Y8-82521-31-00
9 ft.	6Y8-82521-41-00
12 ft.	6Y8-82521-51-00

## Y-COP® installed with Twin or Triple installations with Command Link® Main Switches

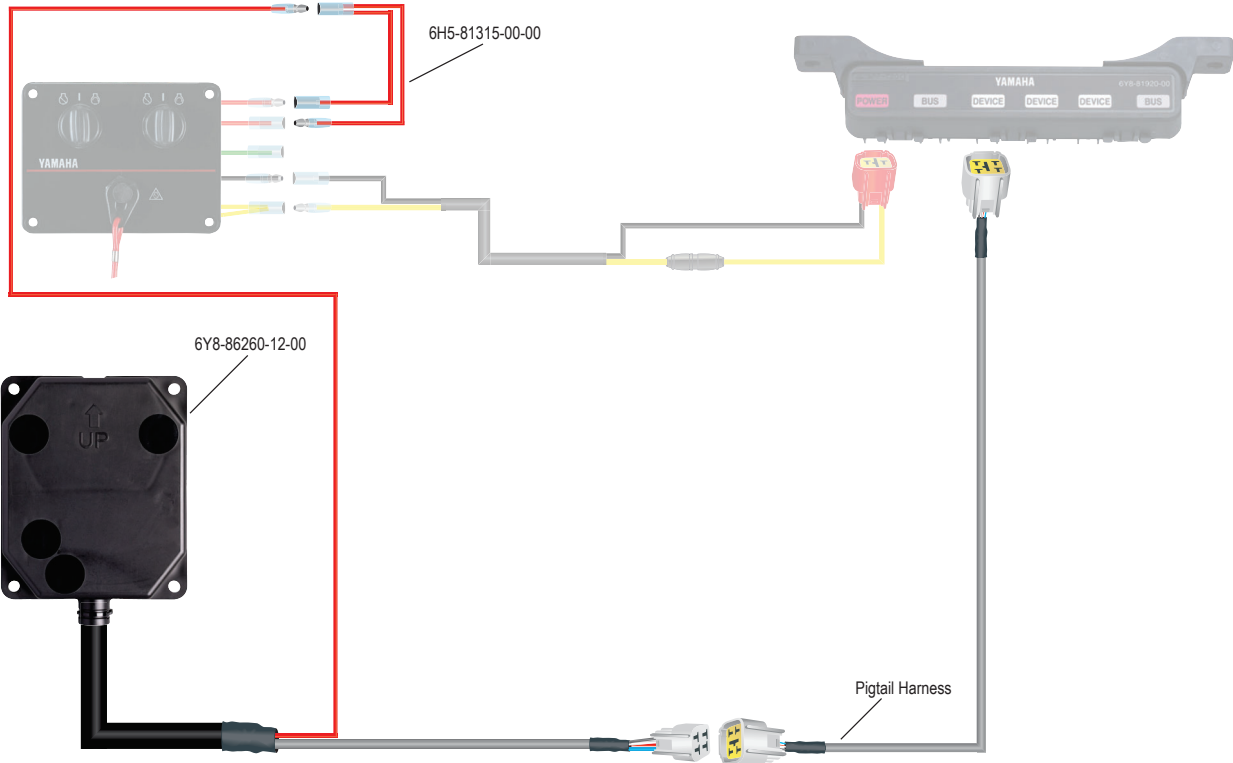

### Parts order list for basic installation:

Quantity	Description	Part Number
1	Y-COP® Kit	6Y8-762D0-00-00
1	Adaptor Harness	6H5-81315-00-00
1	Pigtail Harness	See List <sup>1</sup>

<sup>1</sup> Pigtail Harnesses	
1 ft.	6Y8-82521-01-00
2 ft.	6Y8-82521-11-00
3 ft.	6Y8-82521-21-00
6 ft.	6Y8-82521-31-00
9 ft.	6Y8-82521-41-00
12 ft.	6Y8-82521-51-00

# Rigging Estimate Guide

General Information

Rigging Estimate Guide (Diagrams)

Rigging Components

Electrical Components

Engine Accessories

Propellers

Maintenance Items

Yamalube & Trailer Supplies

Accessories & Apparel

## Y-COP® installed with Twin or Triple installations with Command Link Plus® Main Switches

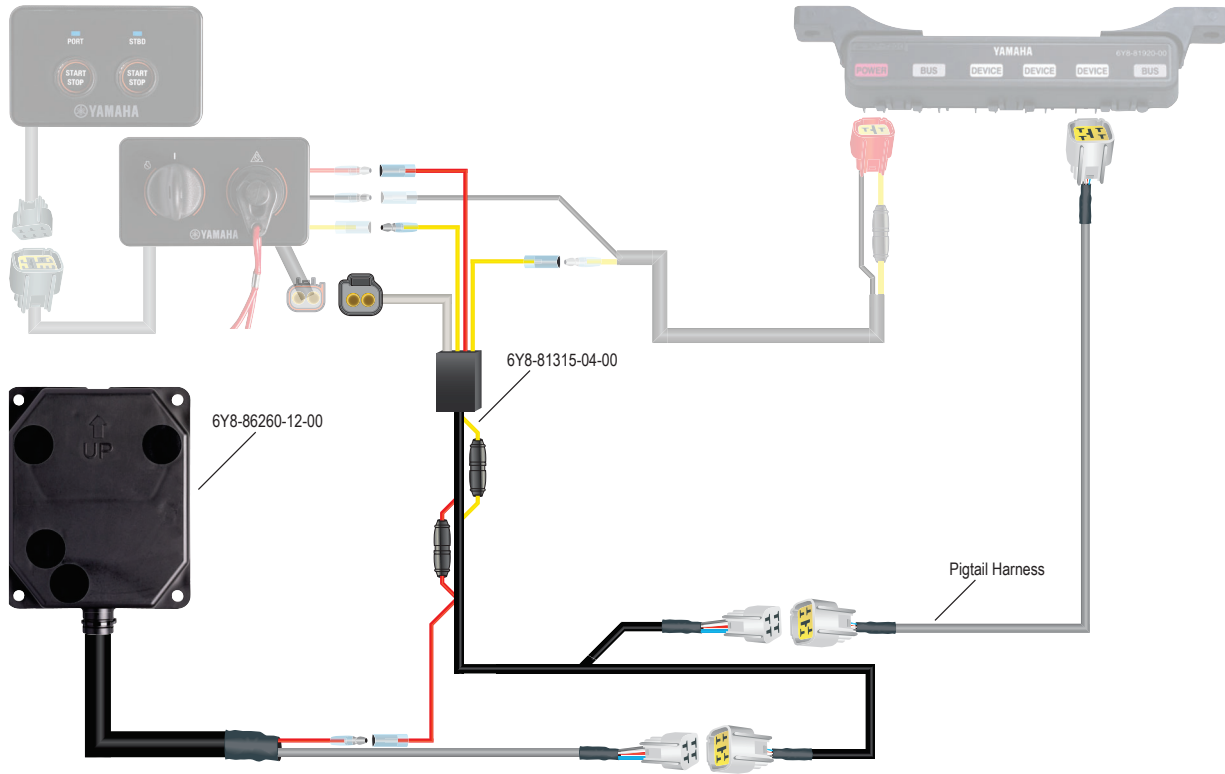

### Parts order list for basic installation:

Quantity	Description	Part Number
1	Y-COP® Kit	6Y8-762D0-00-00
1	Adaptor Harness	6Y8-81315-04-00
1	Pigtail Harness	See List <sup>1</sup>

<sup>1</sup> Pigtail Harnesses	
1 ft.	6Y8-82521-01-00
2 ft.	6Y8-82521-11-00
3 ft.	6Y8-82521-21-00
6 ft.	6Y8-82521-31-00
9 ft.	6Y8-82521-41-00
12 ft.	6Y8-82521-51-00

## Adding in a Bow Thruster Must have Full Maneuverability

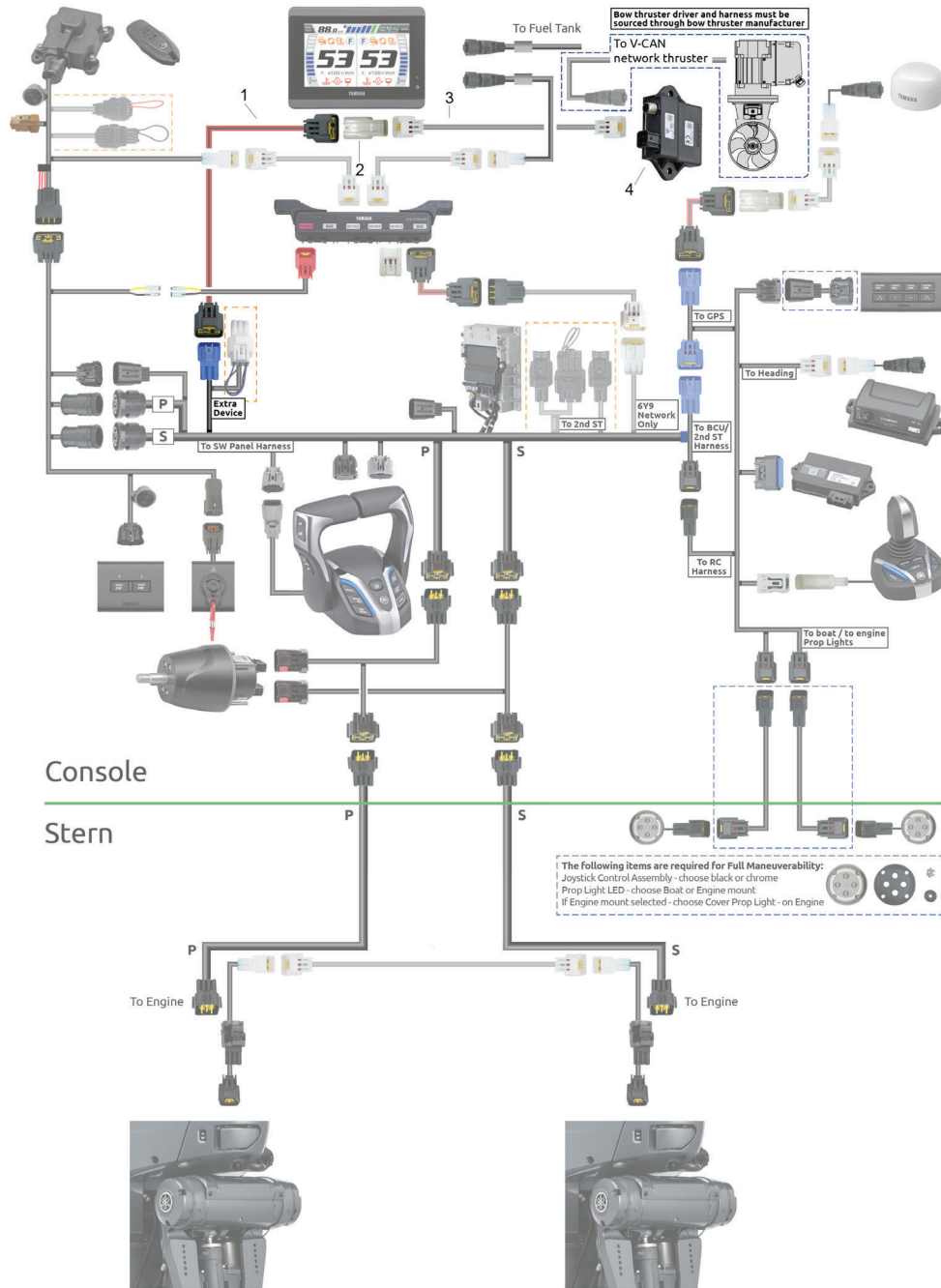

Ref #	Qty	Description	Part Number
1	1	Main Bus Wire	See List <sup>1</sup>
2	1	Inline Hub	6Y8-81920-11-00
3	1	Pigtail Bus Wire	See List <sup>2</sup>
4	1	Thruster Driver	6X9-86510-00-00

<sup>1</sup> Main Bus Wire	
1 ft.	6Y8-82553-01-00
10 ft.	6Y8-82553-50-00
15 ft.	6Y8-82553-11-00
20 ft.	6Y8-82553-21-00
25 ft.	6Y8-82553-31-00
30 ft.	6Y8-82553-41-00

<sup>2</sup> Pigtail Bus Wire	
1 ft.	6Y8-82521-01-00
2 ft.	6Y8-82521-11-00
3 ft.	6Y8-82521-21-00
6 ft.	6Y8-82521-31-00
9 ft.	6Y8-82521-41-00
12 ft.	6Y8-82521-51-00



<b>Description</b>	<b>Page</b>
Gauges	3-1
Combination Analog Gauges	3-6
Analog Gauges	3-7
Digital Electronic Control (DEC) Gauge Kits	3-9
Command Link® Gauge Kits	
Single Engine Gauge Kits	3-12
Twin Engine Gauge Kits	3-15
Multifunction Gauge Kits	
Single Engine Gauge Kits	3-16
Helm Master® EX Main Station Kits	3-17
Helm Master® EX Second Station Kits	3-21
Helm Master® EX Steering Kits	3-25
Control Boxes	
Helm Master® EX Digital Electronic Control Boxes	3-26
Mechanical Control Boxes	3-27
Tiller Handles	3-29
Control Cables	3-30
Control Cable Ends	3-31
Main Switches	
Helm Master® EX Main Switches	3-32
Command Link Plus® Main Switches	3-34
Command Link® and Conventional Main Station Switch Panels	3-36
Command Link® and Conventional Second Station Switch Panels	3-38
Replacement Keys and Key Covers	3-39

General  
Information

Rigging Estimate  
Guide (Diagrams)

**Rigging  
Components**

Electrical  
Components

Engine  
Accessories

Propellers

Maintenance  
Items

Yamaha® &  
Trailer Supplies

Accessories  
& Apparel



## Gauges



### MFD Interface Type 1

Yamaha's integrated information systems are simple. The MFD Interface Type-1 mounts under the helm and allows compatible Garmin® MFD's to display engine information and maintain touchscreen functionality.

**6YM-8A2D0-11-00**



### MFD Interface Type 2

An MFD Interface Type-2 mounts under the helm and provides Yamaha video data of engine information to Yamaha Approved, third-party MFD's Via an HDMI. An MFD Interface Type 2 must also use NMEA 2000®.

**6YM-8A201-01-00**

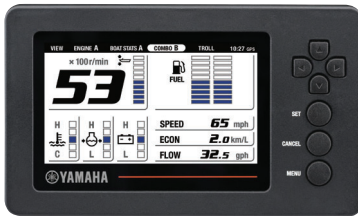

### 6YC Information Station

Today's boater demands convenience, and insists on accurate and instant information about boat and outboard systems. With the plethora of modern electronics, the call is for more information and more available dash space than ever before. Yamaha answers the call with the all-new 6YC "Information Station" display.

**6YC-83710-03-00**

Replacement Cover: 6YC-87278-00-00



### CL5 Display

An all-new, thin Yamaha CL5 touchscreen is small in size but big on information and ability. Its sophisticated, modern design features intuitive operation and matches the latest boat console trends, while its compact size leaves more room on the console for other equipment.

**6YM-83710-17-00**



### Command Link Plus®/Command Link® Round Gauges

Yamaha's integrated information systems are simple, streamlined and sophisticated. These new multi network gauges make the rigging process simple as well by working in both Command Link Plus® and Command Link® networks. Allows the use of the NEW F150's Variable Trolling Speed.

**Round Tachometer: 6Y8-8350T-23-00**

**Round Speed Fuel Meter: 6Y8-83500-23-00**

\* Part number is for gauge(s) only.

## Gauges

### Digital Multifunction Tachometer

Accurate information is available to let you fine tune settings to achieve the best overall efficiency and performance for operating conditions. Designed for optimum visibility and long-term durability. Displays: engine rpm, trim angle, oil level, warning lamps, overheat warning lamp, hour meter for trip (reset able) and total operating hours.

**6Y5-8350T-D2-00\***



### Digital Multifunction Speedometer

Accurate information is available to let you fine tune settings to achieve the best overall efficiency and performance for operating conditions. Designed for optimum visibility and long-term durability. Displays: Speed, trip, time, fuel, low fuel warning-flashes on the lowest bar, battery voltage reading-displays battery output (10~16 volts) and flashes the readout if the output falls below 12 volts.

**6Y5-83570-A1-00\***



### Digital Multifunction Fuel Management Meter

Accurate information is available to let you fine tune settings to achieve the best overall efficiency and performance for operating conditions. Designed for optimum visibility and long-term durability. Displays: Fuel consumption, fuel economy (using speedo or GPS input for readings), fuel contamination warning (when deluxe fuel/water separator is used), engine synchronization (for dual engine applications).

**6Y5-8350F-B2-00\***



### Sport Series Analog Speedometer (0-50 MPH)

This four-inch, backlit, analog gauge displays up to 100 KMH and 50 MPH. It features a modern faceplate design, and comes in either a chrome bezel with black, silver or white faceplates, or a black bezel with a black faceplate.

**White Face w/ Chrome Bezel - N80-8351A-00-00\***

**Silver Face w/ Chrome Bezel - N80-8351A-10-00\***

**Black Face w/ Chrome Bezel - N80-8351A-20-00\***

**Black Face w/ Black Bezel - N80-8351A-30-00\***



### Sport Series Analog Speedometer (0-75 MPH)

This four-inch, backlit, analog gauge displays up to 120 KMH and 75 MPH. It features a modern faceplate design, and comes in either a chrome bezel with black, silver or white faceplates, or a black bezel with a black faceplate.

**White Face w/ Chrome Bezel - N80-83510-00-00\***

**Silver Face w/ Chrome Bezel - N80-83510-10-00\***

**Black Face w/ Chrome Bezel - N80-83510-20-00\***

**Black Face w/ Black Bezel - N80-83510-30-00\***



\* Part number is for gauge(s) only.

## Gauges



### Sport Series Analog Tachometer

This four-inch, backlit, analog gauge displays engine RPMs up to 7000. It features a modern faceplate design, and comes in either a chrome bezel with black, silver or white faceplates, or a black bezel with a black faceplate. All gauge face styles feature warning indicators.

- White Face w/ Chrome Bezel - N80-83540-00-00\***
- Silver Face w/ Chrome Bezel - N80-83540-10-00\***
- Black Face w/ Chrome Bezel - N80-83540-20-00\***
- Black Face w/ Black Bezel - N80-83540-30-00\***



### Sport Series Analog Fuel Level Meter

This two-inch, backlit, analog gauge displays fuel tank levels with accuracy and easy readability. It features a modern faceplate design, and comes in either a chrome bezel with black, silver or white faceplates, or a black bezel with a black faceplate.

- White Face w/ Chrome Bezel - N80-85750-00-00\***
- Silver Face w/ Chrome Bezel - N80-85750-10-00\***
- Black Face w/ Chrome Bezel - N80-85750-20-00\***
- Black Face w/ Black Bezel - N80-85750-30-00\***



### Sport Series Analog Voltage Meter

This two-inch, backlit, analog gauge monitors battery charge level in an easy-to-read format. It features a modern faceplate design, and comes in either a chrome bezel with black, silver or white faceplates, or a black bezel with a black faceplate.

- White Face w/ Chrome Bezel - N80-83503-00-00\***
- Silver Face w/ Chrome Bezel - N80-83503-10-00\***
- Black Face w/ Chrome Bezel - N80-83503-20-00\***
- Black Face w/ Black Bezel - N80-83503-30-00\***



### Sport Series Analog Water Pressure Meter

This two-inch, backlit, analog gauge monitors outboard water pressure in PSI, to alert you to possible overheating. It features a modern faceplate design, and comes in either a chrome bezel with black, silver or white faceplates, or a black bezel with a black faceplate.

- White Face w/ Chrome Bezel - N80-83660-00-00\***
- Silver Face w/ Chrome Bezel - N80-83660-10-00\***
- Black Face w/ Chrome Bezel - N80-83660-20-00\***
- Black Face w/ Black Bezel - N80-83660-30-00\***

\* Part number is for gauge(s) only.

## Gauges

### Sport Series Analog Trim Meter

This two-inch, backlit, analog gauge displays trim position to ensure a smooth ride. It features a modern faceplate design, and comes in either a chrome bezel with black, silver or white faceplates, or a black bezel with a black faceplate.

- White Face w/ Chrome Bezel - N80-83670-00-00\***
- Silver Face w/ Chrome Bezel - N80-83670-10-00\***
- Black Face w/ Chrome Bezel - N80-83670-20-00\***
- Black Face w/ Black Bezel - N80-83670-30-00\***



### Classic Series Analog Speedometer (0-50 MPH)

This four-inch, backlit, analog gauge displays up to 100 KMH and 50 MPH. It features a crisp faceplate design, and comes in either a chrome bezel with black, silver or white faceplates, or a black bezel with a black faceplate.

- White Face w/ Chrome Bezel - N80-8351A-40-00\***
- Silver Face w/ Chrome Bezel - N80-8351A-50-00\***
- Black Face w/ Chrome Bezel - N80-8351A-60-00\***
- Black Face w/ Black Bezel - N80-8351A-70-00\***



### Classic Series Analog Speedometer (0-75 MPH)

This four-inch, backlit, analog gauge displays up to 120 KMH and 75 MPH. It features a crisp faceplate design, and comes in either a chrome bezel with black, silver or white faceplates, or a black bezel with a black faceplate.

- White Face w/ Chrome Bezel - N80-83510-40-00\***
- Silver Face w/ Chrome Bezel - N80-83510-50-00\***
- Black Face w/ Chrome Bezel - N80-83510-60-00\***
- Black Face w/ Black Bezel - N80-83510-70-00\***



### Classic Series Analog Tachometer

This four-inch, backlit, analog gauge displays engine RPMs up to 7000. It features a crisp faceplate design, and comes in either a chrome bezel with black, silver or white faceplates, or a black bezel with a black faceplate. All gauge face styles feature warning indicators.

- White Face w/ Chrome Bezel - N80-83540-40-00\***
- Silver Face w/ Chrome Bezel - N80-83540-50-00\***
- Black Face w/ Chrome Bezel - N80-83540-60-00\***
- Black Face w/ Black Bezel - N80-83540-70-00\***



\* Part number is for gauge(s) only.

General  
Information

Rigging Estimate  
Guide (Diagrams)

**Rigging  
Components**

Electrical  
Components

Engine  
Accessories

Propellers

Maintenance  
Items

Yamaha &  
Trailer Supplies

Accessories  
& Apparel

## Gauges



### Classic Series Analog Fuel Level Meter

This two-inch, backlit, analog gauge displays fuel tank levels with accuracy and easy readability. It features a crisp faceplate design, and comes in either a chrome bezel with black, silver or white faceplates, or a black bezel with a black faceplate.

**White Face w/ Chrome Bezel - N80-85750-40-00\***

**Silver Face w/ Chrome Bezel - N80-85750-50-00\***

**Black Face w/ Chrome Bezel - N80-85750-60-00\***

**Black Face w/ Black Bezel - N80-85750-70-00\***



### Classic Series Analog Voltage Meter

This two-inch, backlit, analog gauge monitors battery charge level in an easy-to-read format. It features a crisp faceplate design, and comes in either a chrome bezel with black, silver or white faceplates, or a black bezel with a black faceplate.

**White Face w/ Chrome Bezel - N80-83503-40-00\***

**Silver Face w/ Chrome Bezel - N80-83503-50-00\***

**Black Face w/ Chrome Bezel - N80-83503-60-00\***

**Black Face w/ Black Bezel - N80-83503-70-00\***



### Classic Series Analog Water Pressure Meter

This two-inch, backlit, analog gauge monitors outboard water pressure in PSI, to alert you to possible overheating. It features a crisp faceplate design, and comes in either a chrome bezel with black, silver or white faceplates, or a black bezel with a black faceplate.

**White Face w/ Chrome Bezel - N80-83660-40-00\***

**Silver Face w/ Chrome Bezel - N80-83660-50-00\***

**Black Face w/ Chrome Bezel - N80-83660-60-00\***

**Black Face w/ Black Bezel - N80-83660-70-00\***



### Classic Series Analog Trim Meter

This two-inch, backlit, analog gauge displays trim position to ensure a smooth ride. It features a crisp faceplate design, and comes in either a chrome bezel with black, silver or white faceplates, or a black bezel with a black faceplate.

**White Face w/ Chrome Bezel - N80-83670-40-00\***

**Silver Face w/ Chrome Bezel - N80-83670-50-00\***

**Black Face w/ Chrome Bezel - N80-83670-60-00\***

**Black Face w/ Black Bezel - N80-83670-70-00\***

\* Part number is for gauge(s) only.

## Analog Combo Gauges



### Chrome Bezel | White

These New 4 inch, backlit, Combination Gauges, feature the same styling cues, but with a space-saving design, they combine key functions so fewer gauges are required.

**Multifunction (Speed 75/Fuel) - N80-8350S-00-00\***

**Multifunction (Tach/Trim) - N80-8350T-00-00\***

**Multifunction (Speed 50/Fuel) - N80-8350S-40-00\***



### Chrome Bezel | Silver

These New 4 inch, backlit, Combination Gauges, feature the same styling cues, but with a space-saving design, they combine key functions so fewer gauges are required.

**Multifunction (Speed 75/Fuel) - N80-8350S-10-00\***

**Multifunction (Tach/Trim) - N80-8350T-10-00\***

**Multifunction (Speed 50/Fuel) - N80-8350S-50-00\***



### Chrome Bezel | Black

These New 4 inch, backlit, Combination Gauges, feature the same styling cues, but with a space-saving design, they combine key functions so fewer gauges are required.

**Multifunction (Speed 75/Fuel) - N80-8350S-20-00\***

**Multifunction (Tach/Trim) - N80-8350T-20-00\***

**Multifunction (Speed 50/Fuel) - N80-8350S-60-00\***



### Black Bezel | Black

These New 4 inch, backlit, Combination Gauges, feature the same styling cues, but with a space-saving design, they combine key functions so fewer gauges are required.

**Multifunction (Speed 75/Fuel) - N80-8350S-30-00\***

**Multifunction (Tach/Trim) - N80-8350T-30-00\***

**Multifunction (Speed 50/Fuel) - N80-8350S-70-00\***

## Gauges



### Pro Series™ (0-50 MPH) Speedometer

Yamaha's Pro Series quality instrumentation provides you with high accuracy, and easy readability in virtually all conditions. Direct faceplate illumination on gauges allows for easy night-time viewing. Displays MPH and KM/H.

**6Y5-83510-12-00\***



### Pro Series™ (0-75 MPH) MPH Speedometer

Yamaha's Pro Series quality instrumentation provides you with high accuracy, and easy readability in virtually all conditions. Direct faceplate illumination on gauges allows for easy night-time viewing. Displays MPH and KM/H.

**6Y5-83510-00-00\***



### Pro Series™ Tachometer

Yamaha's Pro Series quality instrumentation provides you with high accuracy, and easy readability in virtually all conditions. Direct faceplate illumination on gauges allows for easy night-time viewing.

**6Y5-83540-15-00\***



### Pro Series™ Tachometer for Four-Stroke Engines

Yamaha's Pro Series quality instrumentation provides you with high accuracy, and easy readability in virtually all conditions. Direct faceplate illumination on gauges allows for easy night-time viewing. Includes oil pressure and overheat warning indicators.

**6Y5-83540-22-00\***



### Pro Series™ Tachometer with Two-Stroke Oil Indicators

Yamaha's Pro Series quality instrumentation provides you with high accuracy, and easy readability in virtually all conditions. Direct faceplate illumination on gauges allows for easy night-time viewing.

**6Y5-83540-06-00\***

\* Part number is for gauge(s) only.

## Gauges



### Pro Series™ Fuel Level Meter

Yamaha's Pro Series quality instrumentation provides you with high accuracy, and easy readability in virtually all conditions. Direct faceplate illumination on gauges allows for easy night-time viewing.

**6Y5-85750-11-00\***



### Pro Series™ Voltage Meter

Yamaha's Pro Series quality instrumentation provides you with high accuracy, and easy readability in virtually all conditions. Direct faceplate illumination on gauges allows for easy night-time viewing.

**6Y5-83503-01-00\***



### Pro Series™ Water Temperature Meter

Yamaha's Pro Series quality instrumentation provides you with high accuracy, and easy readability in virtually all conditions. Direct faceplate illumination on gauges allows for easy night-time viewing. Requires temperature sender (688-83591-00-00) for installation.

**6Y5-83590-02-00\***



### Pro Series™ Water Pressure Meter

Yamaha's Pro Series quality instrumentation provides you with high accuracy, and easy readability in virtually all conditions. Direct faceplate illumination on gauges allows for easy night-time viewing. Requires pressure sender (688-83667-01-00) for installation.

**6Y5-83660-11-00\***



### Pro Series™ Trim Meter

Yamaha's Pro Series quality instrumentation provides you with high accuracy, and easy readability in virtually all conditions. Direct faceplate illumination on gauges allows for easy night-time viewing. Requires pressure sender.

**2 Wire Sender - 6Y5-83670-13-00\***



### Pro Series™ Hour Meter

Yamaha's Pro Series quality instrumentation provides you with high accuracy, and easy readability in virtually all conditions.

**6Y5-83504-13-00\***

\* Part number is for gauge(s) only.



## Digital Electronic Control (DEC) Gauge Kits

Yamaha's DEC gauge kits offer you convenient rigging solutions. There are several configurations to meet most applications, and offer a great price advantage over individual components. Most installations will require additional parts, see section 1 for additional rigging information.



### MFD Interface Type 1 Kit

Kit Includes:

Qty	Description	Part Number
1	MFD Interface Unit For compatible GARMIN® MFD	6YM-8A2D0-11-00



### MFD Interface Type 2 Kit MAR-CL000-KT-00

Kit Includes:

Qty	Description	Part Number
1	Gateway NMEA 2000® Wire Lead	6YG-82521-00-00
1	CL0 Unit & Remote For compatible Third Party MFD	6YM-8A201-01-00
1	HDMI Cable	6YM-8533A-00-00



### MFD Interface Installation Kit MAR-CL0D1-KT-00

Kit Includes:

Qty	Description	Part Number
1	Multi-Hub Assy	6Y8-81920-01-00
1	Cap 1 (4Pin)	6Y8-82582-11-00
1	Wire, Lead	6YM-8356N-00-00
1	Wire, Lead	6Y9-83553-00-00
1	CL0 Conv Harness	6YM-83553-10-00
1	Power Lead, 8ft.	6Y8-83553-02-00
1	Caution Tag	6X9-2818R-00-00



### CL5 Display Kit MAR-CL5DU-KT-00

Kit Includes:

Qty	Description	Part Number
1	CL5 Display Unit	6YM-83710-17-00
1	Wire Lead	6YM-83553-00-00



## Digital Electronic Control (DEC) Gauge Kits

### Command Link Plus® CL5/CL7 Display Installation Kit (DEC Engines)

#### MAR-CL7D1-KT-30

Kit Includes:

Qty	Description	Part Number
1	Multi-Hub	6Y8-81920-01-00
1	Cap 1, 4 Pin	6Y8-82582-11-00
1	Power Lead, 8ft.	6Y8-83553-02-00
1	Main Bus Harness	6Y9-83553-00-00
1	Fuel Tank Sender Lead	6YD-8356N-00-00



### Command Link Plus® Installation Kit

#### MAR-CLPDI-KT-10

Kit Includes:

Qty	Description	Part Number
1	Wire Lead for GPS	6Y9-8356N-01-00
1	Wire Lead for Fuel Tank Sender	6Y9-8356N-10-00
1	Wire Lead for CLP, Control Box to Main Bus	6Y9-83553-00-00
1	Multi-Hub Assembly	6Y8-81920-01-00
2	Cap, 4 Pin	6Y8-82582-11-00
1	Power Lead, 8ft.	6Y8-83553-02-00
1	Wiring Diagram	6Y9-2819K-E0-00



### 6YC Display Single/Twin Engine DEC Kit 6X6-0E83C-00-00

Kit Includes:

Qty	Description	Part Number
1	6YC Display	6YC-83710-03-00
1	Multi-Hub Assembly	6Y8-81920-01-00
2	Cap, 4 Pin	6Y8-82582-11-00
1	Power Lead, 8ft.	6Y8-83553-02-00
1	Fuel Sender and GPS Wire Lead	6Y8-8356N-01-00
1	Wire Lead for CLP, Control Box to Main Bus	6Y9-83553-00-00
1	6YC Meter Guide	6YC-2819U-70-E0



(Most installations will require additional parts, see section 2 for additional rigging information)

General Information

Rigging Estimate Guide (Diagrams)

Rigging Components

Electrical Components

Engine Accessories

Propellers

Maintenance Items

Yamaha & Trailer Supplies

Accessories & Apparel

## Digital Electronic Control (DEC) Gauge Kits



### DEC Single Engine Main Station Command Link® Kit Round Two Gauge Kit: 6X6-0E83R-21-00

Kit Includes:

Qty	Description	Part Number
1	Tachometer Assy.	6Y8-8350T-23-00
1	Meter Assy. (Speed/Fuel)	6Y8-83500-23-00
1	Multi-Hub Assembly	6Y8-81920-01-00
1	Power Lead, 8 ft.	6Y8-83553-02-00
1	Cap, 4 Pin	6Y8-82582-11-00
1	Fuel Sender and GPS Wire Lead	6Y8-8356N-01-00
1	User Operation Guide	6Y8-2819W-70-E0
1	CLP wire 1ft	6Y9-83553-00-00
1	Main Bus Harness, 1ft	6Y8-82553-01-00



### DEC Twin Engine Main Station Command Link® Kit Round Three Gauge Kit: 6X6-0E83R-31-00

Kit Includes:

Qty	Description	Part Number
2	Tachometer Assy.	6Y8-8350T-23-00
1	Meter Assy. (Speed/Fuel)	6Y8-83500-23-00
1	Multi-Hub Assembly	6Y8-81920-01-00
1	Power Lead, 8 ft.	6Y8-83553-02-00
1	Main Bus Harness, 1ft	6Y8-82553-01-00
1	Fuel Sender and GPS Wire Lead	6Y8-8356N-01-00
1	User Operation Guide	6Y8-2819W-70-E0
1	CLP wire 1ft	6Y9-83553-00-00



### DEC Triple Engine Main Station Command Link® Kit Round Four Gauge Kit: 6X6-0E83R-41-00

Kit Includes:

Qty	Description	Part Number
3	Tachometer Assy.	6Y8-8350T-23-00
1	Meter Assy. (Speed/Fuel)	6Y8-83500-23-00
2	Multi-Hub Assembly	6Y8-81920-01-00
1	Power Lead, 8 ft.	6Y8-83553-02-00
1	Cap, 2 Pin	6Y8-82582-01-00
2	Cap, 4 Pin	6Y8-82582-11-00
2	Main Bus Harness, 1ft	6Y8-82553-01-00
1	Fuel Sender and GPS Wire Lead	6Y8-8356N-01-00
1	User Operation Guide	6Y8-2819W-70-E0
1	CLP wire 1ft	6Y9-83553-00-00

(Most installations will require additional parts, see section 2 for additional rigging information)

## Command Link® Single Engine Gauge Kits

### Command Link® Single Engine Gauge Kit

(This kit DOES NOT allow for accessories like a gateway to be added)

#### Round One Gauge Kit: 6Y8-0E83R-81-00

Kit Includes:

Qty	Description	Part Number
1	Tachometer Assy.	6Y8-8350T-23-00
1	Orange Main Bus With Power Lead (14ft)	6Y8-82553-60-00
1	Dual Fuse Harness	6Y8-83553-N1-00
1	Pigtail Harness, 2ft.	6Y8-82521-11-00
1	Pigtail Harness, 12 ft.	6Y8-82521-51-00
2	Single Hub	6Y8-81920-11-00
1	User Operation Guide	6Y8-2819W-70-E0



### Command Link® Single Engine Gauge Kit

#### Round One Gauge Kit: 6Y8-0E83R-61-00

Kit Includes:

Qty	Description	Part Number
1	Tachometer Assy.	6Y8-8350T-23-00
2	Multi-Hub Assembly	6Y8-81920-01-00
1	Power Lead, 8 ft.	6Y8-83553-02-00
1	Cap, 2 Pin	6Y8-82582-01-00
4	Cap, 4 Pin	6Y8-82582-11-00
1	Pigtail Harness, Engine to Rear Hub, 9 ft.	6Y8-82521-41-00
1	User Operation Guide	6Y8-2819W-70-E0



### Command Link® Single Engine Gauge Kit

(This kit DOES NOT allow for accessories like a gateway to be added)

#### Round Two Gauge Kit: 6Y8-0E83R-91-00

Kit Includes:

Qty	Description	Part Number
1	Tachometer Assy.	6Y8-8350T-23-00
1	Meter Assy. (Speed/Fuel)	6Y8-83500-23-00
1	Y-Split	6Y8-82521-80-00
1	Dual Fuse Harness	6Y5-83553-N1-00
1	Orange Main Bus With Power Lead (14ft)	6Y8-82553-60-00
2	Single Hub	6Y8-81920-11-00
1	Pigtail Harness, 12 ft.	6Y8-82521-51-00
1	Fuel Sender and GPS Wire Lead	6Y8-8356N-01-00
1	Module 1 Sensor	60V-8A4L1-1C-00
1	User Operation Guide	6Y8-2819W-70-E0



(Most installations will require additional parts, see section 2 for additional rigging information)

## Command Link® Single Engine Gauge Kits

### Command Link® Single Engine Gauge Kit

#### Round Two Gauge Kit: 6Y8-0E83R-71-00

Kit Includes:



Qty	Description	Part Number
1	Tachometer Assy.	6Y8-8350T-23-00
1	Meter Assy. (Speed/Fuel)	6Y8-83500-23-00
1	Multi-Hub Assembly	6Y8-81920-01-00
1	In-Line Hub	6Y8-81920-11-00
1	Power Lead, 8 ft.	6Y8-83553-02-00
1	Cap, 4 Pin	6Y8-82582-11-00
1	Module 1 Sensor	60V-8A4L1-1C-00
1	Fuel Sender and GPS Wire Lead	6Y8-8356N-01-00
1	Pigtail Harness, Engine to Rear Hub, 6 ft.	6Y8-82521-31-00
1	User Operation Guide	6Y8-2819W-70-E0

### Command Link® Single Engine Gauge Kit

#### Round Two Gauge Kit: 6Y8-0E83R-41-00

Kit Includes:



Qty	Description	Part Number
1	Tachometer Assy.	6Y8-8350T-23-00
1	Meter Assy. (Speed/Fuel)	6Y8-83500-23-00
2	Multi-Hub Assembly	6Y8-81920-01-00
1	Power Lead, 8 ft.	6Y8-83553-02-00
1	Cap, 2 Pin	6Y8-82582-01-00
3	Cap, 4 Pin	6Y8-82582-11-00
1	Module 1 sensor	60V-8A4L1-1C-00
1	Fuel Sender and GPS Wire Lead	6Y8-8356N-01-00
1	Pigtail Harness, Engine to Rear Hub, 12 ft.	6Y8-82521-51-00
1	User Operation Guide	6Y8-2819W-70-E0

### Command Link® Single Engine 6YC Display Kit with In-Line Hub

#### 6YC Kit: 6YC-0E83C-30-00

Kit Includes:

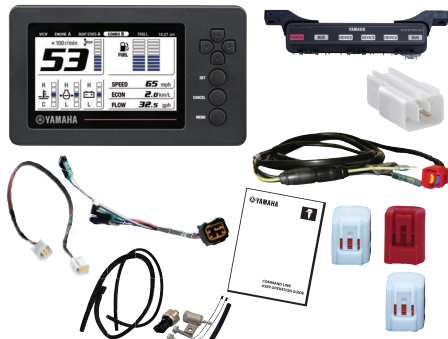

Qty	Description	Part Number
1	6YC Display	6YC-83710-03-00
1	Multi-Hub Assembly	6Y8-81920-01-00
1	In-Line Hub	6Y8-81920-11-00
2	Cap, 4 Pin	6Y8-82582-11-00
1	Power Lead, 8 ft.	6Y8-83553-02-00
1	Fuel Sender and GPS Wire Lead	6Y8-8356N-01-00
1	6 ft. Pig Tail, Engine to rear hub	6Y8-82521-31-00
1	Module 1 Sensor	60V-8A4L1-1C-00
1	6YC Meter Guide	6YC-2819U-70-E0

(Most installations will require additional parts, see section 2 for additional rigging information)

## Command Link® Single Engine Gauge Kits

### Command Link® Single/Twin Engine 6YC Display Kit

**6YC Kit: 6YC-0E83C-00-00**

Kit Includes:

Qty	Description	Part Number
1	6YC Display	6YC-83710-03-00
2	Multi-Hub Assembly	6Y8-81920-01-00
4	Cap, 4 Pin	6Y8-82582-11-00
1	Cap, 2 Pin	6Y8-82582-01-00
1	Power Lead, 8 ft.	6Y8-83553-02-00
1	Fuel Sender and GPS Wire Lead	6Y8-8356N-01-00
1	12 ft. Pig Tail, Engine to rear hub	6Y8-82521-51-00
1	Module 1 Sensor	60V-8A4L1-1C-00
1	6YC Meter Guide	6YC-2819U-70-E0



### Command Link® Single Engine 6YC Display Kit with 704 Control Box

**6YC Kit: 6YC-0E83C-10-00**

Kit Includes:

Qty	Description	Part Number
1	6YC Display	6YC-83710-03-00
1	704 Single Binnacle Control Box	704-48205-R1-00
1	Single Engine Main Switch	704-82570-13-00
2	Multi-Hub Assembly	6Y8-81920-01-00
4	Cap, 4 Pin	6Y8-82582-11-00
1	Cap, 2 Pin	6Y8-82582-01-00
1	Power Lead, 8 ft.	6Y8-83553-02-00
1	Fuel Sender and GPS Wire Lead	6Y8-8356N-01-00
1	12 ft. Pig Tail, Engine to rear hub	6Y8-82521-51-00
1	23ft. 10 Pin Main Harness	688-8258A-70-00
1	Module 1 Sensor	60V-8A4L1-1C-00
1	6YC Meter Guide	6YC-2819U-70-E0



*(Most installations will require additional parts, see section 2 for additional rigging information)*

## Command Link® Twin Engine Gauge Kits

### Command Link® Twin Engine Gauge Kit with 704 Control Box Round Three Gauge Kit: 6Y8-0E83R-51-00

Kit Includes:



Qty	Description	Part Number
2	Tachometer Assy.	6Y8-8350T-23-00
1	Meter Assy. (Speed/Fuel)	6Y8-83500-23-00
2	Multi-Hub Assembly	6Y8-81920-01-00
1	Power Lead, 8 ft.	6Y8-83553-02-00
1	Cap, 2 Pin	6Y8-82582-01-00
1	Cap, 4 Pin	6Y8-82582-11-00
1	Module 1 Sensor	60V-8A4L1-1C-00
1	704 Twin Engine Binnacle Control Box	704-48207-R1-00
1	Twin Engine Main Switch Panel Assembly	6Y8-82570-05-00
1	Fuel Sender and GPS Wire Lead	6Y8-8356N-01-00
1	Main Wire Harness, 10 Pin, 26.2 ft.	6K1-8258A-41-00
1	Main Wire Harness, 10 Pin, 31.2 ft.	61B-8258A-02-00
2	Pigtail Harness, Engine to Rear Hub, 12 ft.	6Y8-82521-51-00
1	User Operation Guide	6Y8-2819W-70-E0

### Command Link® Twin Engine 6YC Display Kit with 704 Control Box

**6YC Kit: 6YC-0E83C-20-00**

Kit Includes:



Qty	Description	Part Number
1	6YC Display	6YC-83710-03-00
1	704 Twin Binnacle Control Box	704-48207-R1-00
1	Twin Engine Main Switch	6Y8-82570-05-00
2	Multi-Hub Assembly	6Y8-81920-01-00
3	Cap, 4 Pin	6Y8-82582-11-00
1	Cap, 2 Pin	6Y8-82582-01-00
1	Power Lead, 8 ft.	6Y8-83553-05-00
1	Fuel Sender and GPS Wire Lead	6Y8-8356N-01-00
2	12 ft. Pig Tail, Engine to rear hub	6Y8-82521-51-00
1	31ft. 10 Pin Main Harness	61B-8258A-02-00
1	26ft. 10 Pin Main Harness	6K1-8258A-41-00
1	Module 1 Sensor	60V-8A4L1-1C-00
1	6YC Meter Guide	6YC-2819U-70-E0

(Most installations will require additional parts, see section 2 for additional rigging information)

## Multifunction Gauge Kits

### Multifunction Single Engine Fuel Management Kit\* Multifunction One Gauge Kit: 6Y5-W0088-57-00

Kit Includes:

Qty	Description	Part Number
1	Multifunction Fuel Management Gauge	6Y5-8350F-B2-00
1	Fuel Flow Sensor Harness, 8.0m	6Y5-83553-F1-00
1	Fuel Flow Sensor	6Y5-85752-02-00
2	Screw	90158-06003-00
1	Wire Extension	703-82531-00-00
1	Wire Lead	6Y5-82117-00-00
2	Clamp	90465-10098-00



\*For twin engines add one (1) 6Y5-85752-02-00

*(Most installations will require additional parts, see section 2 for additional rigging information)*



## Helm Master® EX Main Station Kits

### Single Engine Main Station Kit

YDIS Connection (BPS Scan Port Harness): 90890-06979-00



Level 1 through Level 4 Includes:

#### Level 1

Qty	Description	Part Number
1	6X9 Single Binnacle	6X9-48205-22-00
1	Gauge Kit	MAR-CL5DU-KT-00
1	CL5 Display	6YM-83710-17-00
1	Conversion Harness	6YM-83553-00-00
1	CL7/CL5 Install Kit	MAR-CL7D1-KT-30
1	Fuel Tank Wire	6YD-8356N-00-00
1	Multi-hub	6Y8-81920-01-00
1	Conversion Harness	6Y9-83553-00-00
1	Main Bus Wire	See Page 4-5
2	Pigtail Bus Wire	See Page 4-5
1	System Power Supply Wire	6Y8-83553-02-00
2	4-Pin Waterproof Cap	6Y8-82582-11-00
	EKS Kit	6X9-762E0-42-00
1	EKS Harness	6X9-82716-21-00
1	Engine Shut-off Switch	6X9-82570-71-00
1	Key Fob and Receiver Assy	6X9-762D0-15-00
1	2ft Pigtail	6Y8-82521-11-00
1	Main-Harness (16P)	See Page 4-5

#### Level 2

Qty	Description	Part Number
1	Steering Kit	6X9-762S0-03-00
1	Bolt-on Steering Actuator	6X9-42401-11-00
1	Split Harness	6X9-8258A-90-00
1	Steering Actuator Harness	See Page 4-3
1	Main-Harness (16P)	See Page 4-5
1	Helm and Tilt kit	6GR-762H0-11-00
1	Helm Unit Assy	6GR-615A0-11-00
1	Tilt Helm Unit	6GR-6154A-01-00
1	Fixed Helm Kit	6X9-762H0-10-00
1	Helm Harness (Main/Single)	See Page 4-2

#### Level 3

Qty	Description	Part Number
1	Autopilot Kit	6X9-762P0-0B-00
1	Autopilot Panel	6X9-8253V-02-00
1	GPS Unit	6X9-88107-02-00
1	Heading Sensor	6X9-8A410-02-00
1	BCU	6X9-8591T-15-00
1	Single Hub	6Y8-81920-11-00
1	BCU Harness	6X9-82386-02-00
2	Conversion Harness	6YM-83553-00-00
1	Main Bus Wire	See Page 4-5
1	Pigtail Bus Wire	See Page 4-5
1	BCU Harness Extension	See Page 4-3 (Optional)

#### Level 4

Qty	Description	Part Number
1	Joystick Kit	MAR-762J0-40-00
1	Joystick Controller Assy*	6X9-482A0-02-00 (Chrome)
2	LED Assy (Prop Lights)**	6ES-83720-03-00
1	Extension Harness	See Page 4-1

\*Joystick Controller Assy ALTERNATIVE PART NUMBER  
6X9-482A0-10-00 (BLACK)

\*\*Prop Light LED ( On Engine) 6KN-762A0-01-00  
See Page 2-20 for Prop Light Cover Options.

See Page number for Size Options.

## Helm Master® EX Main Station Kits

### Twin Engine Main Station Kit

YDIS Connection (BPS Scan Port Harness): 90890-06979-00



Level 1 through Level 4 Includes:

#### Level 1

Qty	Description	Part Number
1	6X9 Twin DEC	6X9-48207-22-00
1	Gauge Kit	MAR-CL5DU-KT-00
1	CL5 Display	6YM-83710-17-00
1	Conversion Harness	6YM-83553-00-00
1	CL7/CL5 Install Kit	MAR-CL7D1-KT-30
1	Fuel Tank Wire	6YD-8356N-00-00
1	Multi-Hub	6Y8-81920-01-00
1	Conversion Harness	6Y9-83553-00-00
1	Main Bus Wire	See Page 4-5
2	Pigtail Bus Wire	See Page 4-5
1	System Power Supply Wire	6Y8-83553-02-00
2	4-Pin Waterproof Cap	6Y8-82582-11-00
1	EKS Kit	6X9-762E0-52-00
1	Individual Start/Stop SW	6X9-82570-32-00
1	EKS Harness	6X9-82716-32-00
1	Engine Shut-off Switch	6X9-82570-81-00
1	Key Fob and Receiver Assy	6X9-762D0-15-00
1	2ft Pigtail	6Y8-82521-11-00
2	Main-Harness (16P)	See Page 4-5

#### Level 2

Qty	Description	Part Number
2	Steering Kit	6X9-762S0-03-00
2	Bolt-on Steering Actuator	6X9-42401-11-00
2	Split Harness	6X9-8258A-90-00
2	Steering Actuator Harness	See Page 4-3
2	Main-Harness (16P)	See Page 4-5
1	Helm and Tilt Kit	6GR-762H0-11-00
1	Helm Unit Assembly	6GR-615A0-11-00
1	Tilt Helm Unit	6GR-6154A-01-00
1	Fixed Helm Kit	6X9-762H0-10-00
2	Helm Harness (Main/Multi)	See Page 4-2
2	SCU Link Harness (Port/Stbd)	See Page 4-3
1	SCU Link Harness (Center)	See Page 4-3

#### Level 3

Qty	Description	Part Number
1	Autopilot Kit	6X9-762P0-0B-00
1	Autopilot Panel	6X9-8253V-02-00
1	GPS Unit	6X9-88107-02-00
1	Heading Sensor	6X9-8A410-02-00
1	BCU	6X9-8591T-14-00
1	Single Hub	6Y8-81920-11-00
1	BCU harness	6X9-82386-02-00
2	Conversion Harness	6YM-83553-00-00
1	Main Bus Wire	See Page 4-5
1	Pigtail Bus Wire	See Page 4-5
1	BCU Harness Extension	See Page 4-3 (Optional)

#### Level 4

Qty	Description	Part Number
1	Joystick Kit	MAR-762J0-50-00
1	Joystick Controller Assy*	6X9-482A0-02-00 (Chrome)
2	LED Assy (Prop Lights)**	6ES-83720-03-00
1	BCU	6X9-8591T-25-00
2	Extension Harness	See Page 4-1

\*Joystick Controller Assy ALTERNATIVE PART NUMBER  
6X9-482A0-10-00(BLACK)

\*\*LED Assy (On Engine) 6KN-762A0-01-00  
See page 2-27 for Prop Light Covers for on engine Install.

See Page number for Size Options.

## Helm Master® EX Main Station Kits

### Triple Engine Main Station Kit

YDIS Connection (BPS Scan Port Harness): 90890-06979-00



Level 1 through Level 4 Includes:

#### Level 1

Qty	Description	Part Number
1	6X9 Triple DEC	6X9-48208-11-00
1	Gauge Kit	MAR-CL5DU-KT-00
1	CL5 Display	6YM-83710-17-00
1	Conversion Harness	6YM-83553-00-00
1	CL7/CL5 Install Kit	MAR-CL7D1-KT-30
1	Fuel Tank Wire	6YD-8356N-00-00
1	Multi-Hub	6Y8-81920-01-00
1	Conversion Harness	6Y9-83553-00-00
1	Main Bus Wire	See Page 4-5
1	Pigtail Bus Wire	See Page 4-5
1	System Power Supply Wire	6Y8-83553-02-00
2	4-Pin Waterproof Cap	6Y8-82582-11-00
1	Switch Kit	6X9-762E0-61-00
1	Individual Start/Stop SW	6X9-82570-42-00
1	EKS Harness	6X9-82716-41-00
1	Engine Shut-off Switch	6X9-82570-C1-00
1	Key Fob and Receiver Assy	6X9-762D0-15-00
1	2ft Pigtail	6Y8-82521-11-00
3	Main-Harness (16P)	See Page 4-5

#### Level 2

Qty	Description	Part Number
3	Steering Kit	6X9-762S0-03-00
3	Bolt-on Steering Actuator	6X9-42401-11-00
3	Split Harness	6X9-8258A-90-00
3	Steering Actuator Harness	See Page 4-3
3	Main-Harness (16P)	See Page 4-5
1	Helm and Tilt Kit	6GR-762H0-11-00
1	Helm Unit Assembly	6GR-615A0-11-00
1	Tilt Helm Unit	6GR-6154A-01-00
1	Fixed Helm Kit	6X9-762H0-10-00
2	Helm Harness (Main/Multi)	See Page 4-2
2	SCU Link Harness (Port/Stbd)	See Page 4-3
1	SCU Link Harness (Center)	See Page 4-3

#### Level 3

Qty	Description	Part Number
1	Autopilot Kit	6X9-762P0-0B-00
1	Autopilot Panel	6X9-8253V-02-00
1	GPS Unit	6X9-88107-02-00
1	Heading Sensor	6X9-8A410-02-00
1	BCU	6X9-8591T-15-00
1	Single Hub	6Y8-81920-11-00
1	BCU Harness	6X9-82386-02-00
2	Conversion Harness	6YM-83553-00-00
1	Main Bus Wire	See Page 4-5
1	Pigtail Bus Wire	See Page 4-5
1	BCU Harness Extension	See Page 4-3 (Optional)

#### Level 4

Qty	Description	Part Number
1	Joystick Kit	MAR-762J0-60-00
1	Joystick Controller Assy*	6X9-482A0-03-00 (Chrome)
2	LED Assy (Prop Lights)**	6ES-83720-03-00
1	BCU	6X9-8591T-35-00
2	Extension Harness	See Page 4-1

\*Joystick Controller Assy ALTERNATIVE PART NUMBER  
6X9-482A0-10-00(BLACK)

\*\*LED Assy (On Engine) 6KN-762A0-01-00  
See page 2-31 for Prop Light Covers for on engine Install.

See Page number for Size Options.

## Helm Master® EX Main Station Kits Quad Engine Main Station

YDIS Connection (BPS Scan Port Harness): 90890-06979-00



Level 1 through Level 4 Includes:

### Level 1

Qty	Description	Part Number
1	6X9 Quad DEC	6X9-48209-11-00
1	Gauge Kit	MAR-CL5DU-KT-00
1	CL5 Display	6YM-83710-17-00
1	Conversion Harness	6YM-83553-00-00
1	CL7/CL5 Install Kit	MAR-CL7D1-KT-30
1	Fuel Tank Wire	6YD-8356N-00-00
1	Multi-Hub	6Y8-81920-01-00
1	Conversion Harness	6Y9-83553-00-00
1	Main Bus Wire	See Page 4-5
1	Pigtail Bus Wire	See Page 4-5
1	System Power Supply Wire	6Y8-83553-02-00
2	4-pin Waterproof Cap	6Y8-82582-11-00
1	EKS Kit	6X9-762E0-72-00
1	Individual Start/Stop SW	6X9-82570-52-00
1	EKS Harness	6X9-82716-91-00
1	Emergency Stop SW	6X9-82570-D1-00
1	Key Fob and Receiver Assy	6X9-762D0-15-00
1	2ft Pigtail	6Y8-82521-11-00
4	Main-Harness (16P)	See Page 4-5

### Level 2

Qty	Description	Part Number
4	Steering Kit	6X9-762S0-03-00
4	Bolt-on Steering Actuator	6X9-42401-11-00
4	Split Harness	6X9-8258A-90-00
4	Steering Actuator Harness	See Page 4-3
4	Main-Harness (16P)	See Page 4-5
1	Helm and Tilt Kit	6GR-762H0-11-00
1	Helm Unit Assembly	6GR-615A0-11-00
1	Tilt Helm Unit	6GR-6154A-01-00
1	Fixed Helm Kit	6X9-762H0-10-00
2	Helm Harness (Main/Multi)	See Page 4-2
3	Pigtail Bus Wire	See Page 4-5
2	SCU Link Harness (Center)	See Page 4-3
2	SCU Link Harness (Port/Stbd)	See Page 4-3
4	Main-Harness (16P)	See Page 4-5

### Level 3

Qty	Description	Part Number
1	Autopilot Kit	6X9-762P0-0B-00
1	Autopilot Panel	6X9-8253V-02-00
1	GPS Unit	6X9-88107-02-00
1	Heading Sensor	6X9-8A410-02-00
1	BCU	6X9-8591T-15-00
1	Single Hub	6Y8-81920-11-00
1	BCU Harness	6X9-82386-02-00
2	Conversion Harness	6YM-83553-00-00
1	Main Bus Wire	See Page 4-5
1	Pigtail Bus Wire	See Page 4-5
1	BCU Harness Extension	See Page 4-3 (optional)

### Level 4

Qty	Description	Part Number
1	Joystick Kit	MAR-762J0-70-00
1	Joystick Controller Assy*	6X9-482A0-02-00 (Chrome)
2	LED Assy (Prop Lights)**	6ES-83720-02-00
1	BCU	6X9-8591T-45-00
2	Extension Harness	See Page 4-1

\*Joystick Controller Assy ALTERNATIVE PART NUMBER 6X9-482A0-10-00 (BLACK)

\*\*LED Assy (On Engine) 6KN-762A0-01-00  
See page 2-35 for Prop Light Covers for on engine Install.

See Page number for Size Options.

General Information

Rigging Estimate Guide (Diagrams)

Rigging Components

Electrical Components

Engine Accessories

Propellers

Maintenance Items

Yamaha & Trailer Supplies

Accessories & Apparel

## Helm Master® EX Second Station Kits

### Single Engine Second Station Kit

YDIS Connection (BPS Scan Port Harness): 90890-06979-00



Level 1 through Level 4 Includes:

#### Level 1

Qty	Description	Part Number
1	6X9 Single Binnacle	6X9-48205-30-00
1	Gauge Kit	MAR-CL5DU-KT-00
1	CL5 Display	6YM-83710-17-00
1	Conversion Harness	6YM-83553-00-00
1	EKS Kit	6X9-762E0-81-00
1	EKS harness	6X9-82716-60-00
1	Emergency Stop SW	6X9-82570-71-00
1	Rigging Components Needed	
1	Single-Hub	6Y8-81920-11-00
1	Pigtail Bus Wire	See Page 4-5
1	Main Bus Wire	See Page 4-5
1	2nd Helm Harness	See Page 4-1
1	2nd Helm Harness	See Page 4-1

#### Level 3

Qty	Description	Part Number
1	Autopilot Kit	6X9-762P0-12-00
1	Autopilot Panel	6X9-8253V-02-00
1	BCU Harness	6X9-82386-10-00
1	BCU Harness Extension	See Page 4-3 (Optional)

#### Level 4

Qty	Description	Part Number
1	Joystick Controller Assy*	6X9-482A0-02-00 (Chrome)

\*Joystick Controller Assy ALTERNATIVE PART NUMBER  
6X9-482A0-10-00 (BLACK)

See Page number for Size Options.

#### Level 2

Qty	Description	Part Number
1	Helm and Tilt Kit	6GR-762H0-11-00
1	Helm Unit Assembly	6GR-615A0-11-00
1	Tilt Helm Unit	6GR-6154A-01-00
1	Fixed Helm Kit	6X9-762H0-10-00
1	Helm Harness (2nd station)	6X9-8258A-B1-00

## Helm Master® EX Second Station Kits Twin Engine Second Station Kit

YDIS Connection (BPS Scan Port Harness): 90890-06979-00



Level 1 through Level 4 Includes:

### Level 1

Qty	Description	Part Number
1	6X9 Twin DEC	6X9-48207-30-00
1	Gauge Kit	MAR-CL5DU-KT-00
1	CL5 Display	6YM-83710-17-00
1	Conversion Harness	6YM-83553-00-00
1	EKS Kit	6X9-762E0-91-00
1	Individual Start/Stop SW	6X9-82570-32-00
1	EKS Harness	6X9-82716-71-00
1	Emergency Stop SW	6X9-82570-81-00
1	Rigging Components Needed	
1	Single-Hub	6Y8-81920-11-00
1	Pigtail Bus Wire	See Page 4-5
1	Main Bus Wire	See Page 4-5
1	2nd Helm Harness (Port)	See Page 4-1
1	2nd Helm Harness (Stbd)	See Page 4-2

### Level 2

Qty	Description	Part Number
1	Helm and Tilt Kit	6GR-762H0-11-00
1	Helm Unit Assembly	6GR-615A0-11-00
1	Tilt Helm Unit	6GR-6154A-01-00
1	Fixed Helm Kit	6X9-762H0-10-00*
1	Helm Harness (2nd station)	6X9-8258A-B1-00*

\*Not Included in Kits

### Level 3

Qty	Description	Part Number
1	Autopilot Kit	6X9-762P0-12-00
1	Autopilot Panel	6X9-8253V-02-00
1	BCU Harness	6X9-82386-10-00
1	BCU Harness Extension	See Page 4-3 (Optional)

### Level 4

Qty	Description	Part Number
1	Joystick Controller Assy**	6X9-482A0-02-00 (Chrome)

\*\*Joystick Controller Assy ALTERNATIVE PART NUMBER  
6X9-482A0-10-00 (BLACK)

See Page number for Size Options.

## Helm Master® EX Second Station Kits

### Triple Engine Second Station Kit

YDIS Connection (BPS Scan Port Harness): 90890-06979-00



Level 1 through Level 4 Includes:

#### Level 1

Qty	Description	Part Number
1	6X9 Triple DEC	6X9-48207-30-00
1	Gauge Kit	MAR-CL5DU-KT-00
1	CL5 Display	6YM-83710-17-00
1	Conversion Harness	6YM-83553-00-00
1	EKS Kit	6X9-762E0-A1-00
1	Individual Start/Stop SW	6X9-82570-41-00
1	EKS Harness	6X9-82716-80-00
1	Emergency Stop SW	6X9-82570-C1-00
1	Rigging Components	
1	Single-Hub	6Y8-81920-11-00
1	Pigtail Bus Wire	See Page 4-5
1	Main Bus Wire	See Page 4-5
1	2nd Helm Harness (Port)	See Page 4-1
1	2nd helm Harness (Stbd)	See Page 4-2
1	2nd helm Harness (Center)	See Page 4-2

#### Level 2

Qty	Description	Part Number
1	Helm and Tilt Kit	6GR-762H0-11-00
1	Helm Unit Assembly	6GR-615A0-11-00
1	Tilt Helm Unit	6GR-6154A-01-00
1	Helm Unit Assembly	6X9-762H0-10-00*
1	Helm Harness (2nd Station)	6X9-8258A-B1-00*

\*Not Included in Kit

#### Level 3

Qty	Description	Part Number
1	Autopilot Kit	6X9-762P0-12-00
1	Autopilot Panel	6X9-8253V-02-00
1	BCU Harness	6X9-82386-10-00
1	BCU Harness Extension	See Page 4-3

#### Level 4

Qty	Description	Part Number
1	Joystick Controller Assy**	6X9-482A0-02-00 (Chrome)

\*\*Joystick Controller Assy ALTERNATIVE PART NUMBER  
6X9-482A0-10-00 (BLACK)

See Page number for Size Options.

## Helm Master® EX Second Station Kits

### Quad Engine Second Station Kit

YDIS Connection (BPS Scan Port Harness): 90890-06979-00



Level 1 through Level 4 Includes:

#### Level 1

Qty	Description	Part Number
1	6X9 QUAD DEC	6X9-48207-30-00
1	Gauge Kit	MAR-CL5DU-KT-00
1	CL5 Display	6YM-83710-17-00
1	Conversion Harness	6YM-83553-00-00
1	EKS Kit	6X9-762E0-B1-00
1	Individual Start/Stop SW	6X9-82570-52-00
1	EKS harness	6X9-82716-A0-00
1	Emergency Stop SW	6X9-82570-D1-00
1	Rigging Components	
1	Single-hub	6Y8-81920-11-00
1	Pigtail Bus Wire	See Page 4-5
1	Main Bus Wire	See Page 4-5
1	2nd helm harness (Port)	See Page 4-1
1	2nd helm harness (Stbd)	See Page 4-2
2	2nd helm harness (Center)	See Page 4-2

#### Level 2

Qty	Description	Part Number
1	Helm and Tilt Kit	6GR-762H0-11-00
1	Helm Unit Assembly	6GR-615A0-11-00
1	Tilt Helm Unit	6GR-6154A-01-00
1	Fixed Helm Kit	6X9-762H0-10-00*
1	Helm Harness (2nd Station)	6X9-8258A-B1-00*

\*Not Included in Kit

#### Level 3

Qty	Description	Part Number
1	Autopilot Kit	6X9-762P0-12-00
1	Autopilot Panel	6X9-8253V-02-00
1	BCU harness	6X9-82386-10-00
1	BCU harness extension	See Page 4-3 (Optional)

#### Level 4

Qty	Description	Part Number
1	Joystick Controller Assy**	6X9-482A0-02-00 (Chrome)

\*\*Joystick Controller Assy ALTERNATIVE PART NUMBER  
6X9-482A0-10-00 (BLACK)

See Page number for Size Options.



## Helm Master® EX Steering Kits



### Single Engine Steering Kit 6X9-762S0-03-00

Kit Includes:

Description	Qty	Part Number
Bolt-On steering actuator	1	6X9-42401-11-00
Split Harness	1	6X9-8258A-90-00
Steering Actuator Harness	1	See Page 4-3
Main Harness (16P)	2	See Page 4-5

### Twin Engine Steering Kit 6X9-762S0-03-00 Order X2

Kit Includes:

Description	Qty	Part Number
Bolt-On steering actuator	1	6X9-42401-11-00
Split Harness	1	6X9-8258A-90-00
Steering actuator Harness	2	See Page 4-3
Main Harness (16P)	4	See Page 4-5
SCU Link Harness	2	See Page 4-3
Pigtail Bus Wire	1	See Page 4-5

### Triple Engine Steering Kit 6X9-762S0-03-00 Order X3

Kit Includes:

Description	Qty	Part Number
Bolt-On steering actuator	1	6X9-42401-11-00
Split Harness	1	6X9-8258A-90-00
Steering Actuator Harness	3	See Page 4-3
Main-Harness (16P)	6	See Page 4-5
SCU Link Harness (Port/Stbd)	2	See Page 4-3
SCU Link Harness (Center)	1	See Page 4-3
Pigtail Bus Wire	2	See Page 4-5

### Quad Engine Steering Kit 6X9-762S0-03-00 Order X4

Kit Includes:

Description	Qty	Part Number
Bolt-On steering actuator	1	6X9-42401-11-00
Split Harness	1	6X9-8258A-90-00
Steering Actuator Harness	4	See Page 4-3
Main-Harness (16P)	8	See Page 4-5
SCU Link Harness (Port/Stbd)	2	See Page 4-3
SCU Link Harness (Center)	2	See Page 4-3
Pigtail Bus Wire	3	See Page 4-5

### Helm and Tilt Kit\* 6GR-762H0-11-00

Kit Includes:

Description	Qty	Part Number
Helm Unit Assy	1	6GR-615A0-11-00
Tilt Helm Unit	1	6GR-6154A-01-00
Tilt Helm Set up Manual	1	6GR-2819K-L1-00
Helm Harness	1	See Page 4-2

### Helm and Tilt Kit\* 6GR-762H0-10-00

Kit Includes:

Description	Qty	Part Number
Helm Unit Assy	1	6GR-615A0-11-00
Tilt Helm Unit	1	6GR-6154A-01-00
Tilt Helm Set up Manual	1	6GR-2819K-L1-00
Helm Harness	2	See Page 4-2

### Helm and Tilt Kit\* 6GR-762H0-10-00

Kit Includes:

Description	Qty	Part Number
Helm Unit Assy	1	6GR-615A0-11-00
Tilt Helm Unit	1	6GR-6154A-01-00
Tilt Helm Set up Manual	1	6GR-2819K-L1-00
Helm Harness	2	See Page 4-2

### Helm and Tilt Kit\* 6GR-762H0-10-00

Kit Includes:

Description	Qty	Part Number
Helm Unit Assy	1	6GR-615A0-11-00
Tilt Helm Unit	1	6GR-6154A-01-00
Tilt Helm Set up Manual	1	6GR-2819K-L1-00
Helm Harness	2	See Page 4-2

\*Required if adding Steering **BOLD= KIT**

## Helm Master® EX Digital Electronic Control Boxes

### Helm Master® EX Digital Electronic Controls

The new Digital Electronic Control binnacle is equipped with Integral Power and an All Start/Stop directly on the unit, eliminating the need for separate Power and All Start/Stop switches on the console for both main and second stations. The new Digital Electronic Control grip echoes soft tech grip used on Yamaha's popular Helm Master® EX joystick. Customers can also choose between optional black trim or traditional chrome to customize the binnacle. Installation is simple, whether setting up Helm Master® EX for the first time or performing an upgrade.

Optional black trim must be purchased as trim pieces for remote control main body and wither single or multi-levers.

In single engine applications. Configurations for twin or more outboards continue to use multi-engine start/stop panels to provide individual outboard starting capability.

**Important Compatibility Information:** For use with NEW DEC control Boxes, an additional harness is needed for PY22 and earlier EKS (Electronic Key Switch). The conversion harness is required on all 2nd Station applications. Required on Single, Triple, and Quad main Stations. Please see 4-4.



**Single Engine Flush Control**  
 6X9-48206-21-00  
 6X9-48206-30-00 (Black)  
**Second Station Control**  
 6X9-48206-12-00  
 6X9-48206-40-00 (Black)



**Single Engine Binnacle Control**  
 6X9-48205-22-00  
**Second Station Control**  
 6X9-48205-30-00



**Twin Engine Binnacle Control**  
 6X9-48207-22-00  
**Second Station Control**  
 6X9-48207-30-00



**Triple Engine Binnacle Control**  
 6X9-48208-11-00  
**Second Station Control**  
 6X9-48207-30-00



**Quad Engine Binnacle Control**  
 6X9-48209-11-00  
**Second Station Control**  
 6X9-48207-30-00



**Quint Engine Binnacle Control**  
 6X9-48210-10-00  
**Second Station Control**  
 6X9-48207-30-00



**Main body**  
 6X9-48400-20-00



**Single Lever Cover Kit**  
 6X9-46130-00-00



**Multi Lever Cover Kit**  
 6X9-46130-10-00

## Mechanical Control Boxes

### Mechanical Control Boxes

Classic style and function combined with Yamaha's high standards. The perfect line up of control boxes for mechanical controlled engines.



### 704 Premium Control Boxes

Top-mount binnacle control with a sleek, rounded look that is sure to please today's boater. The 704 allows for effortless, one-hand operation of the throttle and shift of an outboard. Intuitive designs place a thumb-operated, engine trim/tilt switch comfortably on the handle, and feature easily accessible neutral warm-up controls and externally adjustable throttle friction. Stylish chrome finish.

**Single Engine: 704-48205-R1-00**

**Single Engine with Neutral Stop switch: 704-48205-T0-00**

**Twin Engine: 704-48207-R1-00**



### Triple Binnacle Control Box

This uniquely designed triple control box allows for one hand operation for easier maneuverability. The unique triple control box has a built-in water drain tube for added reliability & long term durability. Easy access cable connection location for faster & easier rigging.

**6X5-48207-03-00**

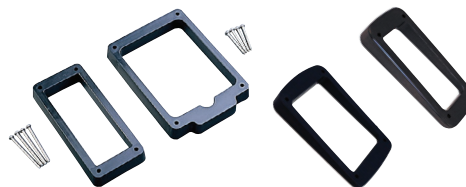

### Mechanical Binnacle Spacers

Designed to raise the 704 Binnacle Control to provide more clearance for the lever in idle and full-throttle positions.

**Standard Single Flat Spacer: 704-48293-00-00**

**Premium Single Flat Spacer: 704-48293-20-00**

**Premium Single Angled Spacer: MAR-SHIM8-63-00**

**Premium Twin Flat Spacer: 704-48293-30-00**

**Premium Twin Angled Spacer: MAR-SHIM8-64-00**

## Mechanical Control Boxes



### Flush Mount Control Boxes

Includes thumb-operated trim/tilt switch, neutral switch and push-button neutral warm-up. Fits most single engine applications and they're perfect for a bass boat.

#### Flush Mount Control Box:

Right Side Mount\* (w/ stop switch) - **6X3-48206-11-00**

Left Side Mount (w/o stop switch) - **6X3-48206-22-00**

\* Right Side Mount emergency stop lanyard  
682-82556-00-00



### Mechanical 703 Side Mount Control Boxes

Designed for use with electric start Yamaha outboards. Features include:

Convenient easy-to-use fast-idle lever for fast warm-up. Key switch for added security forward/reverse lever. 703 control boxes include a key switch, stop lanyard, and 16 foot main harness.

**Push to Open, 10 Pin Harness: 703-48207-25-00**

**Pull to Open w/ Choke, 7 Pin Harness: 703-48230-24-00**

**Trim switch cover: 703-48224-00-00**

**Replacement 10 Pin Harness: 688-8258A-20-00**

**Replacement 7 Pin Harness: 688-82586-21-00**

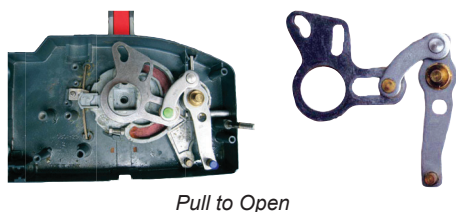

Pull to Open

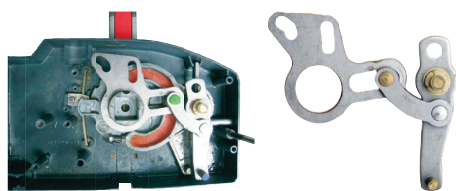

Push to Open

### Side Mount Throttle Conversion

Although the control boxes available may not meet your throttle style, the parts below can be ordered to convert a side mount box to the throttle style you need.

**703 Push to Open Conversion: 703-48261-01-00**

**703 Pull to Open Conversion: 703-48261-11-00**

**701 Push to Open Conversion: 701-48261-20-00**

**701 Pull to Open Conversion: 701-48261-00-00**



### Mechanical 701 Side Mount Control Boxes

Designed specifically for most manual start Yamaha outboards. A single forward/reverse control lever and a separate fast idle lever provide easy operation.

**Port Side Mount, Pull to Open Throttle:**

**703-48260-23-00**

## Tiller Handles

Yamaha's Multifunction Tiller Handle combines ergonomic design, smooth shifting, fingertip controls and an extended throttle handle for virtually effortless maneuverability. Add to that Yamaha's exclusive Variable Trolling RPM Switch (VTS® F40LA through F90 models only) and a 90° throttle rotation angle, and steering is not only easy, it's more comfortable too. It's easy to see why our Multifunction Tiller Handle won an IBEX® Innovation Award in 2005.

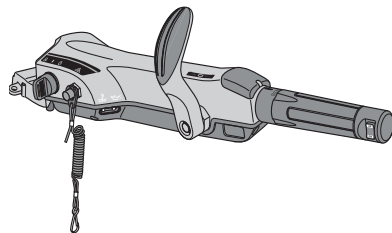

### F25 Complete Tiller Handle Assembly (~2016)

Includes everything required to mount a tiller handle on F25 Outboard produced until 2016.

**6X4-42103-0E-00**



### Tiller Handle Main Assembly

The tiller handle main assembly requires the use of a fitting kit below to mount to a Yamaha Outboard.

**6X4-42103-5C-00**

### Tiller Handle Fitting Kits

The fitting kits are used along with the Main Handle Assembly. They typically include the wire harness and mounting hardware.



#### 2-Stroke Fitting Kits

Application	Part Number
40 / 50	6X4-42102-65-00
60 / 70	6X4-42102-53-00
80 / 90	6X4-42102-43-00

#### 4 Stroke Fitting Kits

Application	Part Number
F20B	6X4-42102-K2-00
F/T25C*	6X4-42102-E2-00
F40B (carbureted)	6X4-42102-33-00
F30 / F40LA (EFI)	6X4-42102-72-00
F/T50 / F/T60 / F70	6X4-42102-24-00
F75A / F90A	6X4-42102-14-00
F75B / F90B / VF90A	6X4-42102-J3-00
F115/F115A	6X4-42102-04-00
F115B / VF115B	6X4-42102-H3-00

\*F25C kit comes w/ VTS switch and steering friction  
\*Non PTT F25C models will need a smaller friction plate which is sold separately, 6FM-42525-00-00

## Control Cables

### Premier II™ Control Cables

Yamaha is pleased to offer Premier II cables. They offer an ultra-low-friction splined inner core. The design allows tighter tolerances resulting in reduced end play. We highly recommend the use of Premier II cables for boats with several applications and long cable lengths, on dual-station boats, and on any boat for unrivaled smoothness. (cables do not include cable ends)

Cable Length	Individual Part Number	10 Pack Part Number
4 Ft.	MAR-CABLE-04-SC	N/A
6 Ft.	MAR-CABLE-06-SC	MAR-CABLE-06-BK
7 Ft.	MAR-CABLE-07-SC	MAR-CABLE-07-BK
8 Ft.	MAR-CABLE-08-SC	MAR-CABLE-08-BK
9 Ft.	MAR-CABLE-09-SC	MAR-CABLE-09-BK
10 Ft.	MAR-CABLE-10-SC	MAR-CABLE-10-BK
11 Ft.	MAR-CABLE-11-SC	MAR-CABLE-11-BK
12 Ft.	MAR-CABLE-12-SC	MAR-CABLE-12-BK
13 Ft.	MAR-CABLE-13-SC	MAR-CABLE-13-BK
14 Ft.	MAR-CABLE-14-SC	MAR-CABLE-14-BK
15 Ft.	MAR-CABLE-15-SC	MAR-CABLE-15-BK
16 Ft.	MAR-CABLE-16-SC	MAR-CABLE-16-BK
17 Ft.	MAR-CABLE-17-SC	MAR-CABLE-17-BK
18 Ft.	MAR-CABLE-18-SC	MAR-CABLE-18-BK
19 Ft.	MAR-CABLE-19-SC	MAR-CABLE-19-BK
20 Ft.	MAR-CABLE-20-SC	MAR-CABLE-20-BK
21 Ft.	MAR-CABLE-21-SC	MAR-CABLE-21-BK
22 Ft.	MAR-CABLE-22-SC	MAR-CABLE-22-BK
23 Ft.	MAR-CABLE-23-SC	MAR-CABLE-23-BK
24 Ft.	MAR-CABLE-24-SC	MAR-CABLE-24-BK
25 Ft.	MAR-CABLE-25-SC	MAR-CABLE-25-BK
26 Ft.	MAR-CABLE-26-SC	MAR-CABLE-26-BK
27 Ft.	MAR-CABLE-27-SC	MAR-CABLE-27-BK
28 Ft.	MAR-CABLE-28-SC	MAR-CABLE-28-BK
29 Ft.	MAR-CABLE-29-SC	MAR-CABLE-29-BK
30 Ft.	MAR-CABLE-30-SC	MAR-CABLE-30-BK
32 Ft.	MAR-CABLE-32-SC	N/A
34 Ft.	MAR-CABLE-34-SC	N/A
36 Ft.	MAR-CABLE-36-SC	N/A
38 Ft.	MAR-CABLE-38-SC	N/A
40 Ft.	MAR-CABLE-40-SC	N/A

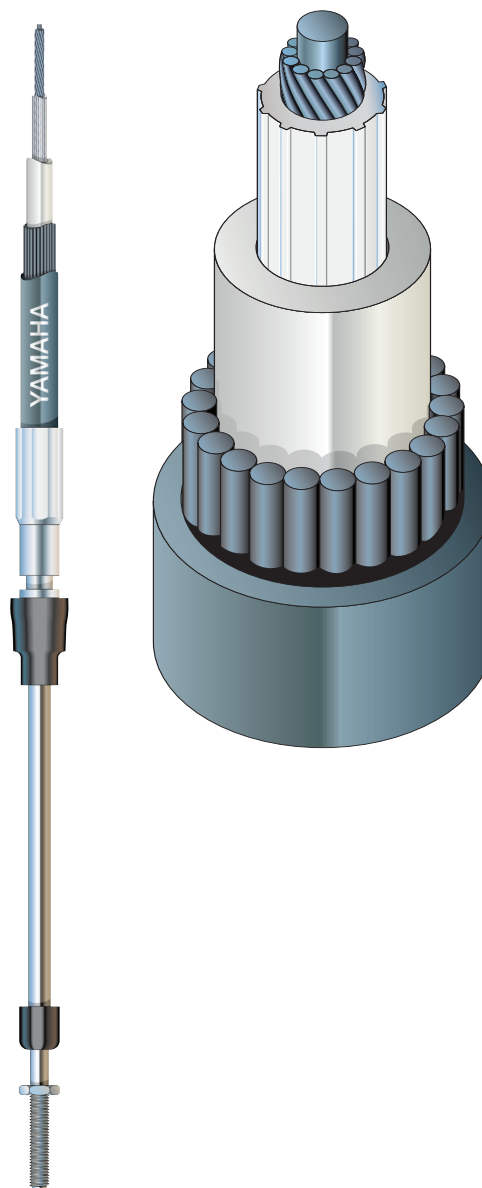

# Rigging Components

## Throttle and Shift Cable Ends

From time to time control cables need new ends. The following list provides a guide to selecting the correct one. The most current information can always be found using Parts Manager Pro™ Online through YMBS.



## Control Cable Ends

**Shift and Throttle Ends: 703-48345-01-00**  
**Fastener for Cables Ends: 93430-06024-00**

### Engine Control Cable Ends

#### Four Stroke

MODEL	THROTTLE	SHIFT	FASTENER
F6, F/T8, F/T9.9(05~)	6FM-48344-00-00	6FM-48344-00-00	90468-18008-00 (Clip)
F/T9.9(~04)	6G8-26363-00-00	6G8-26363-00-00	6G8-26364-00-00 (Slide)
F15 / F20 / F/T25	6FM-48344-00-00	6FM-48344-00-00	90468-18008-00 (Clip)
F20C / F25C / T25C	6FM-48344-00-00	6FM-48344-00-00	90468-18008-00 (Clip)
F30 / F40(06-08)	67C-48344-10-00	67C-48344-10-00	90468-18008-00 (Clip)
F40(99), F/T50(~04)	6G8-26363-00-00	6G8-26363-00-00	90468-18008-00 (Clip)
F40(09~), F/T50(05~), F/T60(02~), F70(11~)	69W-48344-00-00	69W-48344-00-00	90468-18008-00 (Clip)
F75(~16), F80, F90(~16), F/L115(~14)	6FM-48344-00-00	6FM-48344-00-00	90468-18008-00 (Clip)
F90B / F/L115(14~), F/L150~300	6E5-48344-00-00	6E5-48344-00-00	90468-18008-00 (Clip)
VF90 / VF/L115 ~ 250	6E5-48344-00-00	6E5-48344-00-00	90468-18008-00 (Clip)

#### Two Stroke

MODEL	THROTTLE	SHIFT	FASTENER
9.9(96~), 15(96~)	6FM-48344-00-00	6FM-48344-00-00	90468-18008-00 (Clip)
6, 8, 9.9(~95), 15(~95)	682-48340-50-00*	682-48330-50-00*	See Note
25 2cyl., 25/30 3cyl.	6G8-26363-00-00	6G8-26363-00-00	6G8-26364-00-00 (Slide)
C25, C30, C40 2cyl.(89~)	648-48340-50-00*	648-48330-50-00*	See Note
40/50 (~94)	6H4-48344-00-00 (Elec) 6FM-48344-00-00 (Man)	6H4-48344-00-00	90468-18008-00 (Clip)
40/50 (95~)	6H4-48344-00-00 63D-48344-00-00(Man)	6FM-48344-00-00(Elec)	90468-18008-00 (Clip)
C403cyl.(97~02), C50	6H4-48344-00-00	6FM-48344-00-00	90468-18008-00 (Clip)
P50	6H4-48344-00-00	6H4-48344-00-00	90468-18008-00 (Clip)
P60 (~95)	6FM-48344-00-00	6FM-48344-00-00	90468-18008-00 (Clip)
60, P60(96~), C60, C70, 70(96~)	6H3-48344-00-00	6FM-48344-00-00	90468-18008-00 (Clip)
C55 / C75 / P75 / C80 / C85	6FM-48344-00-00	6FM-48344-00-00	90468-18008-00 (Clip)
70(~95)	6FM-48344-00-00	6FM-48344-00-00	90468-18008-00 (Clip)
90 / B90 / C90	6FM-48344-00-00	6FM-48344-00-00	90468-18008-00 (Clip)
S115~130(96~97) 115~200 (84~95)	6E5-48344-00-00	6E5-48344-00-00	90185-06062-00 (Nut)
115~130 (96~)	6E5-48344-00-00	6E5-48344-00-00	90185-06M07-00 (Nut) 90468-18008-00 (Clip)
D/DX 150	6E5-48344-00-00	6E5-48344-00-00	90468-18008-00 (Clip)
Z/LZ/VZ 150~300	6E5-48344-00-00	6E5-48344-00-00	90468-18008-00 (Clip)
S, L, SX, LX 150~250	6E5-48344-00-00	6E5-48344-00-00	90468-18008-00 (Clip)
150~200(96~), 225, 250	6E5-48344-00-00	6E5-48344-00-00	90468-18008-00 (Clip)
V6Spec/V6Excel	6E5-48344-00-00	6E5-48344-00-00	90468-18008-00 (Clip)
V/VX/150~250	6E5-48344-00-00	6E5-48344-00-00	90468-18008-00 (Clip)

\*Includes cable end, cable hook, spring, pin, and washer

## Helm Master® EX Main Switches



### Single Engine Main Station Switch

Yamaha's all new Helm Master® EX keyless panels offer the latest in technology and durability, with a new keyless design. To be used with the new Helm Master® EX EKS System. (Kit Includes Power Switch 6X9-82570-71-00, EKS Harness 6X9-82716-21-00, Emergency Stop Switch 6X9-82570-71-00 and the Key Fob and Receiver 6X9-762D0-15-00)

**6X9-762E0-42-00**



### Twin Engine Main Station Switch Kit

The Twin Engine Main Station Kit offers the latest in technology energizing the ignition system of multiple outboards with a key fob. Optional "All Start" Switch can be added for additional convenience. (Kit includes Individual Start/Stop Switch 6X9-82570-32-00, EKS Harness 6X9-82716-32-00, Emergency Stop Switch 6X9-82570-80-00 and the Key Fob and Receiver 6X9-762D0-15-00)

**6X9-762E0-52-00**



### Triple Engine Main Station Switch Kit

The Triple Engine Main Station Kit offers the latest in technology energizing the ignition system of multiple outboards with a key fob. Optional "All Start" switch can be added for additional convenience. (Kit Includes, EKS Harness 6X9-82716-41-00, Individual Start/Stop Switch 6X9-82570-41-00, Emergency Stop Switch 6X9-82570-C1-00 and the Key Fob and Receiver 6X9-762D0-15-00)

**6X9-762E0-62-00**



### Quad Engine Main Station Switch Kit

The Quad Engine Main Station Kit offers the latest in technology energizing the ignition system of multiple outboards with a key fob. Optional "All Start" switch can be added for additional convenience. (Kit Includes EKS Harness 6X9-82716-91-00, Individual Start/Stop Switch 6X9-82570-52-00, Emergency Stop Switch 6X9-82570-D1-00 and the Key Fob and Receiver 6X9-762D0-15-00)

**6X9-762B0-77-00**



### All Start/ Stop Switch

Allows Multiple Engine Applications to be started successively (to prevent high amperage draw on the starting battery) or stopped simultaneously with the touch of a single button.

**6X9-82570-B2-00**



## Helm Master® EX Second Station Switches



### Single Engine Second Station Kit

Yamaha's Helm Master® EX Second Station Kit allows starting and stopping of the engine with a push of the button from either station. (Kit Includes Start/Stop Switch 6X9-82570-B2-00, EKS Harness 6X9-82716-60-00, Emergency Stop Switch 6X9-82570-71-00)

**6X9-762E0-81-00**



### Twin Engine Second Station Kit

Yamaha's Helm Master® EX Second Station Kit allows starting and stopping of the engine with a push of the button from either station. (Kit includes Individual Start Stop Switch 6X9-82570-32-00, EKS Harness 6X9-82716-71-00, Emergency Stop Switch 6X9-82570-81-00)

**6X9-762E0-91-00**



### Triple Engine Second Station Kit

Yamaha's Helm Master® EX Second Station Kit allows starting and stopping of the engine with a push of the button from either station. (Kit includes Individual Start/Stop Switch 6X9-82570-41-00, EKS Harness 6X9-82716-80-00, Emergency Stop Switch 6X9-82570-C1-00)

**6X9-762E0-A1-00**



### Quad Engine Second Station Kit

Yamaha's Helm Master® EX Second Station Kit allows starting and stopping of the engine with a push of the button from either station. (Kit includes Individual Start/Stop Switch X9-82570-52-00, EKS Harness 6X9-82716-A0-00, Emergency Stop Switch 6X9-82570-D1-00)

**6X9-762E0-B1-00**

## Command Link Plus® Main Switches



### Single Engine Main Station Switch

Yamaha's Command Link Plus® key panels offer the latest in technology and durability, with a new ergonomic key design and new functionality. The single engine switch is the only Command Link Plus key switch to use the conventional key switch connector. Three position switch.

**6X6-82570-34-00**



### Twin Engines Main Station Switch Kit

The Twin Engine Main Switch Kit offers the latest in technology energizing the ignition system of multiple outboards with only one key. Optional "All Start" switch can be added for additional convenience. (Kit includes Main Switch Panel 6X6-82570-41-00 and Twin Start/Stop Panel 6X6-82570-60-00.)

**6X6-762B0-01-00**



### Triple Engines Main Station Switch Kit

The Triple Engine Main Switch Kit offers the latest in technology energizing the ignition system of multiple outboards with only one key. Optional "All Start" switch can be added for additional convenience. (Kit includes Main Switch Panel 6X6-82570-51-00 and Triple Start/Stop Panel 6X6-82570-70-00.)

**6X6-762B0-11-00**



### Quad Engines Main Station Switch Kit

Yamaha's Command Link Plus® key panels offer the latest in technology and durability, with a new ergonomic key design and new functionality. Four keyed alike switches help keep things simple and straight forward. (Kit includes Key Switch Set 6X6-82570-M3-00, Lanyard Panel Assembly 6X6-82570-V0-00, Key Switch Harness 6X6-8258A-L0-00, and Stop Switch Harness 6X6-8258A-U0-00)

**MAR-QUAD1-KT-00**



### All Start/Stop Switch

Allows twin or triple engines to be started successively (to prevent high amperage draw on the starting battery) or stopped simultaneously with the touch of a single button. For convenience and protection, engines cannot be started while running. The All Start/Stop switch can be installed on the main station of triple or twin engine installations only.

**6X6-82570-D0-00**

## Command Link Plus® Main Switches



### Single Engine Second Station Switch Kit

Stylish and functional, Command Link Plus® second station switch kits allow the transfer of control between stations or starting and stopping the engine with the push of a button. (Kit includes two station selector switches 6X6-82570-B0-00, Lanyard Panel Assembly 6X6-82570-90-00, and Start/ Stop Switch 6X6-82570-80-00)

**6X6-762B0-20-00**



### Twin Engines Second Station Switch Kit

Stylish and functional, Command Link Plus® second station switch kits allow the transfer of control between stations or starting and stopping the engine with the push of a button. (Kit includes two station selector switches 6X6-82570-B0-00, Lanyard Panel Assembly 6X6-82570-90-00, and Start/ Stop Switch 6X6-82570-E0-00)

**6X6-762B0-30-00**



### Triple Engines Second Station Switch Kit

Stylish and functional, Command Link Plus® second station switch kits allow the transfer of control between stations or starting and stopping the engine with the push of a button. (Kit includes two station selector switches 6X6-82570-B0-00, Lanyard Panel Assembly 6X6-82570-90-00, and Start/ Stop Switch 6X6-82570-F0-00)

**6X6-762B0-40-00**



### Quad Engines Second Station Switch Kit

Stylish and functional, Command Link Plus® second station switch kits allow the transfer of control between stations or starting and stopping the engine with the push of a button. (Kit includes two station selector switches 6X6-82570-L0-00, Lanyard Panel Assembly 6X6-82570-V0-00, Port Start/ Stop Switch 6X6-82570-J0-00, and Starboard Start / Stop Switch 6X6-82570-K0-00)

**MAR-QUAD2-KT-00**

## Command Link® and Conventional Main Station Switch Panels

### Triple Engine Switch Panel

Designed exclusively for Yamaha's Command Link Integrated Marine Information System. Features interchangeable keys and a single engine stop lanyard for added convenience. Compact size maximizes dash space, simplifies installation. (Replacement Main Switch: 6X5-82510-02-00, Replacement Panel: 6X5-82571-00-00)

**6X5-82570-03-00**

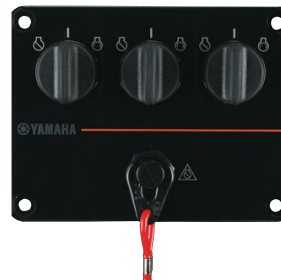

### Twin Engine Switch Panel

Push main switch to choke. With choke and engine warning buzzer. For use with conventional Yamaha rigging only. (Replacement Main Switch: 6K1-82510-08-00, Replacement Panel: 6K1-82571-02-00, Replacement Lanyard: 682-82556-00-00)

**6K1-82570-15-00**



### Command Link® Twin Engine Switch Panel

Designed to work exclusively with Command Link. Interchangeable keys add convenience, and a single engine stop lanyard cuts clutter. Compact size maximizes dash space, simplifies installation. (Replacement Main Switch: 6Y8-82510-03-00, Replacement Panel: 6Y8-82571-01-00, Replacement Lanyard: 682-82556-00-00)

**6Y8-82570-05-00**



### Single Engine Switch Panel

Push main switch to choke. With choke switch and engine warning buzzer. For use with either Command Link or conventional Yamaha rigging. (Replacement Main Switch: 704-82510-0B-00, Replacement Panel: 704-82571-02-00, Replacement Lanyard: 682-82556-00-00)

**704-82570-13-00**



### Single Engine Switch Panel

Includes multi-connector to main harness, connectors for instrument harness, and engine stop lanyard switch. With bullet connectors for generic engine stop lanyard switch. (Replacement Main Switch: 64D-82510-05-00, Replacement Panel: 64D-82571-00-00)

**Standard connector: 64D-82570-06-00**



## Command Link® and Conventional Main Station Switch Panels



### Lanyard Panel

For use with duplex connector and main switch assembly. (Replacement Lanyard: 682-82556-00-00)

**64D-82570-31-00**

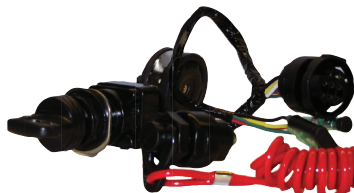

### Single Engine Key Switch Assembly

Main switch and lanyard used in the 704 single engine switch panel, but without the panel. Perfect for custom boat installations. (Replacement Main Switch: 704-82510-0B-00, Replacement Lanyard: 682-82556-00-00)

**704-8257C-04-00**

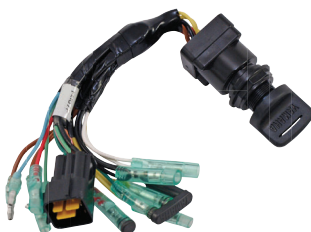

### Tiller Handle Key Switch

For use with the 6X4 tiller handle.

**6X4-82510-02-00**



### Single Engine Key Switch Assembly

With duplex connector for use with 6X3 Flush Side Control. (Replacement Main Switch: 64D-82510-04-00. If a panel is needed, use Single Main Switch on Panel 64D-82570-23-00)

**6X3-8257B-02-00**



### Lanyard Switch

An emergency stop switch without a panel. (Replacement Lanyard: 682-82556-00-00)

**688-82575-02-00**

## Command Link® and Conventional Second Station Switch Panels

### Single Engine Command Link® Second Station Switch Panel

Designed exclusively for Yamaha's Command Link® Integrated Marine Information System and the Synchro Control System. For use on second station only.

**Command Link® Panel: 6X6-82570-01-00**

**Conventional Panel: 6X1-82570-02-00**



### Twin Engine Conventional Second Station Switch Panel

Designed exclusively for use with the Synchro Control System. For use on second station only.

**Command Link® Panel: 6X6-82570-11-00**



### Triple Engine Command Link® Second Station Switch Panel

Designed exclusively for Yamaha's Command Link® Integrated Marine Information System. For use on second station only.

**6X6-82570-20-00**



### Command Link® Station Selector Switch

Designed exclusively for Yamaha's Command Link® Integrated Marine Information System. This switch will not connect to a Command Link® Plus control box.

**6X6-82570-A0-00**



### Command Link Plus® Station Selector Switch

Designed exclusively for Yamaha's Command Link Plus® Integrated Marine Information System. This switch will not connect to a Command Link® control box.

**6X6-82570-B0-00**



## Replacement Keys and Key Covers

### Replacement Keys

When a customer loses a key, Yamaha makes it easy for you to get them a new one.

**If all keys are missing, locate the key number on the main switch barrel.**

#### 700 Series Keys

Key	Part Number	Key	Part Number	Key	Part Number
721	90890-56004-00	732	90890-56008-00	750	90890-56012-00
727	90890-56005-00	733	90890-56009-00	751	90890-56013-00
730	90890-56006-00	741	90890-56010-00	752	90890-56014-00
731	90890-56007-00	747	90890-56011-00	753	90890-56015-00



#### 300 Series Keys

Key	Part Number	Key	Part Number	Key	Part Number
371	90890-55868-00	378	90890-55875-00	385	90890-55882-00
372	90890-55869-00	379	90890-55876-00	386	90890-55883-00
373	90890-55870-00	380	90890-55877-00	387	90890-55884-00
374	90890-55871-00	381	90890-55878-00	388	90890-55885-00
375	90890-55872-00	382	90890-55879-00	389	90890-55886-00
376	90890-55873-00	383	90890-55880-00	390	90890-55887-00
377	90890-55874-00	384	90890-55881-00		

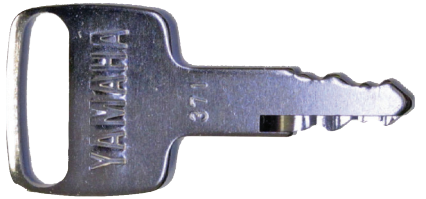

#### 800 Series Keys

Key	Part Number	Key	Part Number	Key	Part Number
821	90890-56016-00	832	90890-56020-00	850	90890-56024-00
827	90890-56017-00	833	90890-56021-00	851	90890-56025-00
830	90890-56018-00	841	90890-56022-00	852	90890-56026-00
831	90890-56019-00	847	90890-56023-00	853	90890-56027-00

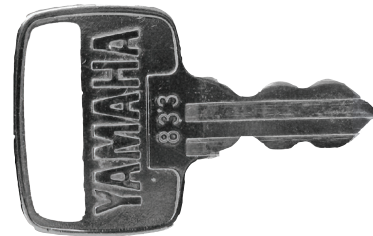

#### 400 Series Keys

Key	Part Number	Key	Part Number	Key	Part Number
451	90890-55820-00	458	90890-55827-00	465	90890-55834-00
452	90890-55821-00	459	90890-55828-00	466	90890-55835-00
453	90890-55822-00	460	90890-55829-00	467	90890-55836-00
454	90890-55823-00	461	90890-55830-00	468	90890-55837-00
455	90890-55824-00	462	90890-55831-00	469	90890-55838-00
456	90890-55825-00	463	90890-55832-00	470	90890-55839-00
457	90890-55826-00	464	90890-55833-00		



#### Command Link®/Command Link Plus® Series Keys

Key	Part Number	Key	Part Number	Key	Part Number
457	6X6-82511-09-A1	832	6X6-82511-09-A5	853	6X6-82511-09-A9
462	6X6-82511-09-A2	833	6X6-82511-09-A6		
463	6X6-82511-09-A3	847	6X6-82511-09-A7		
827	6X6-82511-09-A4	852	6X6-82511-09-A8		



#### Yamaha Key Covers

Key covers are weather resistant and branded with the Yamaha name. Replacement keys come without a cover.

300 / 700 Series Key Cover: 703-82577-00-00

14mm Switch Cover for 300 / 700 Series Keys: 6K1-82532-00-00

400 / 800 Series Key Cover: 676-82577-01-00

15mm Switch Cover for 300 / 700 Series Keys: 703-82532-00-00

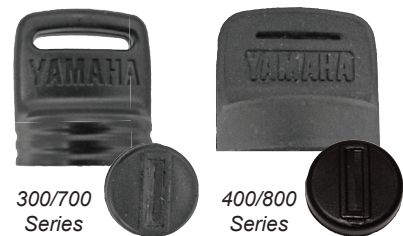

300/700 Series

400/800 Series







<b>Description</b>	<b>Page</b>
Helm Master® Harnesses	4-1
Command Link® and Command Link Plus® Harnesses	4-8
Command Link® and Command Link Plus® Accessories	4-13
Conventional Harnesses	4-17
Conventional Accessories	4-22
Charging, Starting, and Battery Cables	4-23
Switches and Indicators	4-25
Wire Connections and Circuit Protection	4-26

## Helm Master® Harnesses

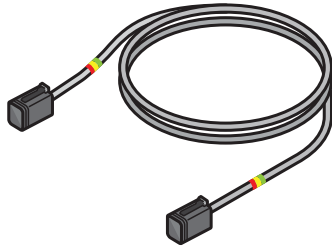

**Helm Control Unit (HCU) to Power Control Unit (PCU) Harness (Legacy Only)**

- 5 ft.- 6ES-82590-70-00
- 10 ft.- 6ES-82590-30-00
- 23 ft.- 6ES-82590-50-00
- 36 ft.- 6ES-82590-10-00

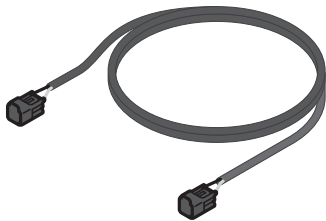

**Steering Sensor Extension Harness (Legacy Only)**

- 6 ft.- 6ES-8258A-90-00
- 12 ft.- 6ES-8258A-A0-00
- 18 ft.- 6ES-8258A-B0-00

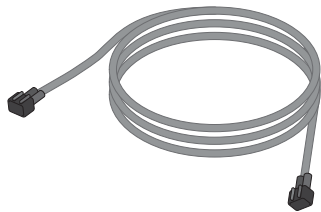

**Prop Light Extension Harness**

- 20 ft.- 6X9-82586-20-00
- 30 ft.- 6X9-82586-30-00
- 40 ft.- 6X9-82586-40-00

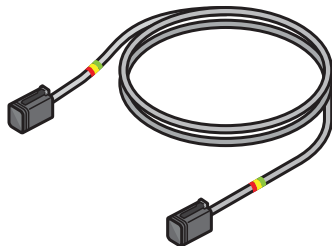

**Steering Control Unit (SCU) to PCU Extension Harness**

- 3.5 ft.- 6ES-8258A-C0-00

## Helm Master®/Helm Master® EX Harnesses

### 2nd Helm Harness Single Engine (Port)

16 ft.- 6X9-8258A-01-00  
 26 ft.- 6X9-8258A-11-00  
 38 ft.- 6X9-8258A-21-00



### 2nd Helm Harness Multiple Engine (Stbd)

16 ft.- 6X9-8258A-31-00  
 26 ft.- 6X9-8258A-41-00  
 38 ft.- 6X9-8258A-51-00



### 2nd Helm Harness Multiple Engine (Center)

16 ft.- 6X9-8258A-60-00  
 26 ft.- 6X9-8258A-70-00  
 38 ft.- 6X9-8258A-80-00



### Split Harness

6X9-8258A-90-00



### Single Engine Helm Harness

Main Station: 3 ft.- 6GR-8258A-01-00  
 6 ft.- 6GR-8258A-41-00  
 (Legacy) 2nd Station: 3 ft.- 6GR-8258A-21-00  
 (EX) 2nd Station: 3 ft.- 6X9-8258A-A1-00



### Multiple Engine Helm Harness

Main Station: 3 ft.- 6GR-8258A-11-00  
 6 ft.- 6GR-8258A-51-00  
 9 ft.- 6GR-8258A-61-00  
 (EX) 2nd Station: 3 ft.- 6X9-8258A-B1-00



## Helm Master® EX Harnesses



**Steering Control Unit (SCU) Link Harness Port/Starboard**

1 ft.- 6X9-81115-00-00  
5 ft.- 6GR-81115-00-00  
10 ft.- 6GR-81115-10-00



**Steering Control Unit (SCU) Link Harness Center Engine(s)**

1 ft.- 6X9-81115-10-00  
5 ft.- 6GR-81115-20-00  
10 ft.- 6GR-81115-30-00

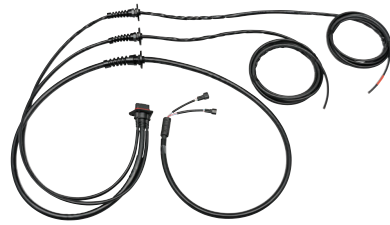

**Steering Actuator Harnesses**

8 ft.- 6X9-438A0-01-00  
15 ft.- 6X9-438A0-11-00  
8 ft. 180° - 6X9-438A0-21-00  
15 ft. 180° - 6X9-438A0-31-00  
No Bulk Head - 6X9-438A0-41-00

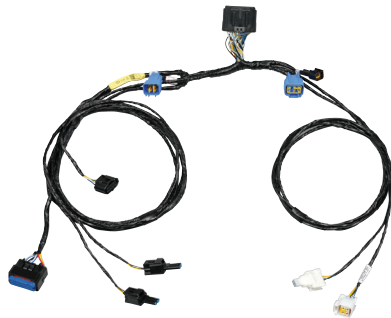

**BCU Harness**

6X9-82386-02-00



**BCU Harness Extension**

15 ft.- 6X9-82521-00-00  
30 ft.- 6X9-82521-10-00



**BCU Harness 2nd Station (only)**

6X9-82386-10-00

## Helm Master® EX Harnesses

### EKS Key Fob and Receiver Assy

**6X9-762D0-15-00**  
**Replacement FOB 6X9-86261-12-00**



- Item may look different than picture shown.

### EKS Harness

**Single Engine - 6X9-82716-21-00**  
**Twin Engine - 6X9-82716-50-00\***  
**Triple Engine - 6X9-82716-41-00\***  
**Quad Engine - 6X9-82716-91-00\***



### EKS Harness 2nd Station

**Single Engine - 6X9-82716-60-00**  
**Twin Engine - 6X9-82716-71-00\***  
**Triple Engine - 6X9-82716-80-00\***  
**Quad Engine - 6X9-82716-A0-00\***



### EKS Conversion harness (Old EKS to New DEC)

**Single Engine - 6X9-8258A-F0-00**  
**Triple Engine - 6X9-8258A-F0-00**  
**Quad Engine - 6X9-8258A-F0-00**

- Twin Engine must have 6X9-82716-32-00 to work properly.



### EKS Conversion Harness (Old EKS to New DEC) 2nd Station

**All 2nd Station DEC Configurations - 6X9-8258A-G0-00**



\*Items May look different than picture shown

## Helm Master® EX Harnesses

### 6x6 to 6x9 Remote Control Harness

*Triple and Quad - 6X9-83553-60-00*



### Switch Extension Harness 23FT

- For use with Joystick Station Kit

**6X9-83553-70-00**



### Switch Extension Harness 32FT

- For use with Joystick Station Kit

**6X9-83553-80-00**



## Helm Master® Harnesses

**6X6 TO 6X9 Single Engine 2nd Station Conversion Harness**

**6X9-83553-20-00**



**6X6 TO 6X9 Twin Engine 2nd Station Conversion Harness**

**6X9-83553-30-00**



**6X6 TO 6X9 Triple Engine 2nd Station Conversion Harness**

**6X9-83553-40-00**



**6X6 TO 6X9 Quad Engine 2nd Station Conversion Harness**

**6X9-83553-50-00**



**XTO 2nd Station Wire harness  
(Only required on 425s with 2nd Station)**

**6GR-8258A-V0-00**



\*Items May look different than picture shown

General Information

Rigging Estimate Guide (Diagrams)

Rigging Components

**Electrical Components**

Engine Accessories

Propellers

Maintenance Items

Yamaha & Trailer Supplies

Accessories & Apparel



General Information

Rigging Estimate Guide (Diagrams)

Rigging Components

**Electrical Components**

Engine Accessories

Propellers

Maintenance Items

Yamalube & Trailer Supplies

Accessories & Apparel

## Helm Master® Harnesses



**Digital Communication Kit**

**6X8-762Y0-00-00**



**Conversion Harness (6-4 Pin)**

**6X9-83553-10-00**



**Battery Management System**

\*Requires Yamaha DEC- capable outboards equipped with Helm Master® EX rigging

*Twin/Triple/Quad* **6X9-762C0-04-00**

*Quint* **6X9-762C0-04-00**

## Command Link® and Command Link® Plus Harnesses

### DEC (Digital Electronic Control) Main Harness

The DEC 16 pin main harness works for both Command Link® Plus (CLP) and the current Command Link® systems. The DEC main harness connects the engine to the main station control box. One per engine is required when rigging.

<b>5 ft.- 6X6-8258A-91-00</b>	<b>26 ft.- 6X6-8258A-21-00</b>
<b>12 ft.- 6X6-8258A-51-00</b>	<b>3.5 ft.- 6X6-8258A-31-00</b>
<b>17 ft.- 6X6-8258A-61-00</b>	<b>39 ft.- 6X6-8258A-41-00</b>
<b>20 ft.- 6X6-8258A-01-00</b>	<b>49 ft.- 6X6-8258A-71-00</b>
<b>23 ft.- 6X6-8258A-11-00</b>	<b>79 ft.- 6X6-8258A-81-00</b>



### Main Bus Harness

The Main Bus Harness is used in Command Link® (CL) and Command Link Plus® systems. The harness has one 6 pin connection on each end and is used to connect multi hubs into the network.

<b>1 ft.- 6Y8-82553-01-00</b>	<b>20 ft.- 6Y8-82553-21-00</b>
<b>10 ft.- 6Y8-82553-50-00</b>	<b>25 ft.- 6Y8-82553-31-00</b>
<b>15 ft.- 6Y8-82553-11-00</b>	<b>30 ft.- 6Y8-82553-41-00</b>



### Command Link® Main Bus Harness with Power Leads

For use with Command Link® systems. Combines the power harness and Main Bus harness to simplify rigging. 14 ft. in length

**6Y8-82553-60-00**

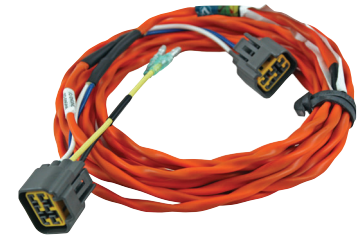

### Pigtail Bus Harness

The Pigtail Harness is used in Command Link® and Command Link Plus® systems. The harness has one 4 pin connection on each end and is used to connect gauges and other items into the network.

<b>1 ft.- 6Y8-82521-01-00</b>	<b>6 ft.- 6Y8-82521-31-00</b>
<b>2 ft.- 6Y8-82521-11-00</b>	<b>9 ft.- 6Y8-82521-41-00</b>
<b>3 ft.- 6Y8-82521-21-00</b>	<b>12 ft.- 6Y8-82521-51-00</b>



### Command Link® Pigtail Y Harness

For use with Command Link® systems. Allows two gauges to be connected to the Command Link® Main Bus with Power Leads with an In-Line Hub.

**6Y8-82521-80-00**



\*Items May look different than picture shown

General  
Information

Rigging Estimate  
Guide (Diagrams)

Rigging  
Components

**Electrical  
Components**

Engine  
Accessories

Propellers

Maintenance  
Items

Yamaha &  
Trailer Supplies

Accessories  
& Apparel

## Command Link® and Command Link® Plus Harnesses



### CL0 Conversion Harness

This 3ft harness supplies power to an MFD Interface Type-1 and Type-2, From the multi hub. Can be used in Command Link, Command Link Plus and Helm Master® EX.

**6YM-83553-10-00**



### CL5 Conversion Harness

The CL5 Conversion Harness connects power from the MFD to the Multi-Hub so that the MFD can display gauges and other information. Compatible with Command Link, Command Link Plus, and Helm Master® EX.

**6YM-83553-00-00**



### HDMI Cable

The HDMI cable is for use with the MFD type-2 to display the information on an approved third-party MFD.

**6YM-8533A-00-00**



### 8 ft. Power Lead Harness

The 8 ft. Power Lead Harness connects power from the key switch to the multi hub for gauges and other components. The harness is used in Command Link® and Command Link Plus® systems.

**6Y8-83553-02-00**



### Multi-Hub Assembly

The Multi-Hub is used in both Command Link and Command Link Plus® systems to allow devices to connect into the network with 1 power supply connector, 2 main BUS connectors, and 3 device connectors.

**6Y8-81920-01-00**



### In-Line Hub Assembly

The In-Line hub is used in both Command Link® and Command Link Plus® systems. The hub works great with the Multisensor or in a simple Command Link® installation. Connects a pigtail harness to a main bus harness.

**6Y8-81920-11-00**

## Command Link® and Command Link® Plus Harnesses

### Red Power 2 Pin Connection Cap

During the installation and rigging process, the number of multi-hubs required may result in unused connector positions. In most installations only one multi-hub will have a used power connection. The rest will require a protective cap.

**6Y8-82582-01-00**



### White Pigtail 4 Pin Connection Cap

During the installation and rigging process, the number of multi-hubs required may result in unused connector positions. The 4 pin cap covers any unused device ports on the multi-hub.

**6Y8-82582-11-00**



### Grey Main Bus Connection Cap with Resistor

During the installation and rigging process, the number of multi-hubs required may result in unused connector positions. One resistor cap is included with a multi-hub assembly.

**6Y8-85371-01-00**



### Command Link Plus® Second Station Primary Harness

The CLP second station primary harness connects the main station control box with the second station control with the help of a secondary harness. The primary harness has one 6 pin connector, one 4 pin connector, and one 3 pin connector on each end. One second station primary harness is required per engine when rigging a second station. For use with CLP control boxes.

**16 ft.- 6X6-8258A-G1-00**

**40 ft.- 6X6-8258A-J1-00**

**26 ft.- 6X6-8258A-H1-00**



### Command Link® 2nd Station Main Harness

The DEC second station main harness connects the main station control box with the second station control with the help of a secondary harness. The second station main harness has one 6 pin, one 4 pin, and one 3 pin connections on each end. One second station primary harness is required per engine when rigging a second station. For use with current Command Link® controls ONLY because of a different style 3 pin connector. Because of the different 3 pin connector, an adaptor harness will be required when a CLP main station is connected to a current Command Link® second station.

**16 ft.- 6X6-8258A-A1-00**

**40 ft.- 6X6-8258A-E1-00**

**26 ft.- 6X6-8258A-C1-00**



## Command Link® and Command Link® Plus Harnesses



### DEC 2nd Station Secondary Harness

The DEC second station primary harness connects the main station control box with the second station control with the primary harness. The secondary harness has one 12 pin connector on the main station side and one 2 pin connection on the second station side. One second station secondary harness is required per engine when rigging a second station. For use with CLP and current Command Link® controls.

**16 ft.- 6X6-8258A-B1-00**  
**26 ft.- 6X6-8258A-D1-00**

**40 ft.- 6X6-8258A-F1-00**



### Quad Second Station Harness

The Quad second station harness connects the main station control box with the second station control with the help of the primary and secondary harness. The Quad second station harness has two 12 pin connectors on the main station side and two 3 pin connectors on the second station side. One Quad second station harness is required along with two CLP primary and two secondary harnesses when rigging a second station. For use with CLP only.

**16 ft.- 6X6-8258A-R0-00**  
**26 ft.- 6X6-8258A-S0-00**

**40 ft.- 6X6-8258A-T0-00**



### Second Station Primary Harness Adaptor

The CLP and original DEC second station controls use a different style 3 pin connector on the primary harness. The adaptor harness will allow the use of a CLP control box for the main station and an original DEC control on the second stations. Perfect for the customer looking to re-power.

**6X6-8258A-K0-00**



### CLP AGI/Gateway Harness

The .3 ft. harness connects a Pigtail Harness to either the AGI or a Gateway. The harness has a wrap of green tape and a male 6 pin at one end with a male 4 pin at the other.

**6Y9-83553-50-00**

### CLP NMEA 2000® Gateway Harness for 6YG Gateway

**6YG-82521-00-00**



### CLP Multisensor Harness

The Multisensor harness has a female 6 pin connector on one end and a male connector on the other. The .7 ft. harness connects a Pigtail Harness to the Multisensor and has a wrap of yellow tape.

**6Y9-83553-60-00**

## Command Link® and Command Link® Plus Harnesses

### CLP Display Harness

The Command Link Plus Display Harness has a 6 pin male connection on one end and a 4 pin female connection on the other. The .5 ft. harness connects a Pigtail Harness to the Command Link Plus Display and has a wrap of black tape in the middle.

**6Y9-83553-40-00**



### Main Bus Y Harness

The Main Bus Y Harness connects the 6 pin control box lead into two main bus harnesses. This harness is used in installations with a CLP Display, Multisensor, and two stations. Please see appropriate diagram for more details.

**6Y9-83553-10-00**



### CLP Main Bus Adaptor Harness

The adaptor harness connects the 6 pin control box lead to a main bus harness. This harness is used in installations with a CLP Display and has a 6 pin connection each end. Please see appropriate diagram for more information.

**6Y9-83553-00-00**



### Fuel Harness for CLP

The Fuel Harness allows the vessel fuel information to be used with the Command Link Plus® Display.

**6Y9-8356N-10-00**



### GPS Harness for CLP

The GPS Harness allows the GPS speed information from a GPS unit to be used with the Command Link Plus® Display.

**6Y9-8356N-01-00**



## Command Link® and Command Link® Plus Accessories



### Fuel Harness for CLP CL5/CL7 Display

The Fuel Harness allows the vessel fuel information to be fed to the Command Link Plus® CL5/CL7 Display.

**6YD-8356N-00-00**

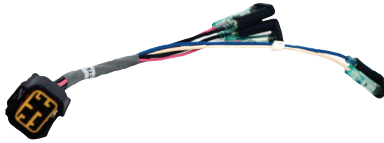

### GPS/Fuel Harness for CL

The GPS/Fuel Harness allows the speed of the vessel from a GPS and the fuel system information from the vessel to be used with the Command Link® system.

**6Y8-8356N-01-00**

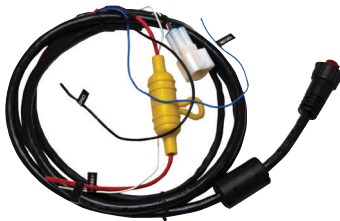

### GPS/Power Harness for CLP CL7 Display

The GPS Harness allows the GPS speed information to be fed to the Command Link Plus® CL7 Display. Also includes the power leads for the GPS antenna.

**6YD-83553-00-00**



### Main Station Key Switch Adaptor Harness

The Main Station Key Switch Adaptor Harness allows the use of a current key switch with a Command Link Plus® control box. One harness is required per key switch, except single engine installations.

**6X6-8258A-L0-00**



### Single 2nd Station Key Switch Adaptor Harness

The adaptor harness allows the use of a current key switch with a Command Link Plus® control box. One harness is required per installation.

**6X6-8258A-M0-00**



### Twin 2nd Station Key Switch Adaptor Harness

The adaptor harness allows the use of a current key switch with a Command Link Plus® control box. One harness is required per installation.

**6X6-8258A-N0-00**



### Triple 2nd Station Key Switch Adaptor Harness

The adaptor harness allows the use of a current key switch with a Command Link Plus® control box. One harness is required per installation.

**6X6-8258A-P0-00**



### 6X7 Flush Mount Key Switch Extension Harness

Used to connect main key switch that would otherwise be too far away for the control box connector to reach.

**6X7-82590-30-00**

## Command Link® and Command Link® Plus Accessories

### Y-COP®

The Electronic Control Module disables the ignition system via an operator controlled key fob. When the operator wishes to use the outboard, a simple command via the wireless key fob activates the ignition system. Two water resistant key fobs are provided with each system. (Replacement Remote: 6AA-86261-22-00, Replacement Unit: 6Y8-86260-12-00, Replacement Decal: 6Y8-48277-00-00) Includes a 2ft. pigtail harness.

**6Y8-762D0-00-00**  
\*Kit Discontinued



**Y-COP® CL Key Switch Harness for Twin and Triple Engine Installations**  
The harness has three one pin connectors to tie Y-COP® into the key switches. Photo not available.

**6Y8-81315-04-00**



### Y-COP® Harness for Multiple Engine Installations

The harness connects to the Key Switches, Power Supply, the Y-COP®, and a Pigtail Bus Harness. This harness is required when using Y-COP® in twin and triple installations with the new CLP key switches.

**6Y8-81315-04-00**

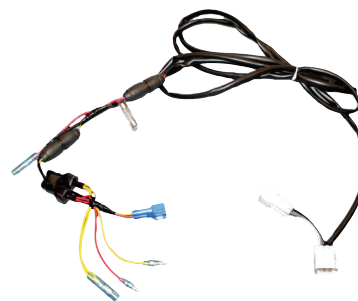

### Power Y Harness for CLP

The Power Y Harness connects the 8 ft. Power Lead to two Multi-Hub assemblies for use with the new CLP Display and CL gauges. Please see appropriate diagram for more details.

**6Y9-83553-20-00**

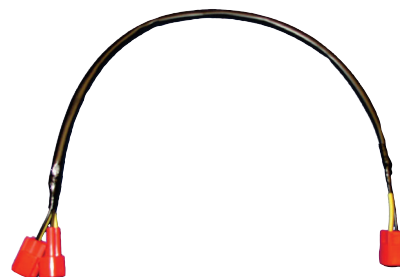



## Command Link® and Command Link® Plus Accessories



### Command Link®/Command Link Plus® Gateway

Yamaha's Gateways allow certain engine and boat data to be displayed on NMEA-2000® compatible displays that are external to the Yamaha system. The Gateway is for installation with a Command Link® or Command Link Plus® networks, such as those found with mechanical controls and/or DEC controls. (2 ft. Command Link and NMEA 2000® pigtails included)

**MAR-GTWAY-KT-20**



### Command Link®/Command Link Plus® Analog Gauge Interface

The Analog Gauge Interface, or AGI, allows Command Link® Plus or Command Link® equipped boats to display selected engine and boat performance data on analog gauges, be they Yamaha or those of most aftermarket manufacturers. The AGI is for installation with a Command Link® or Command Link Plus® network, such as those found with mechanical controls and/or DEC controls. (requires pigtail harness for installation)

**6YH-8A2D0-02-00**

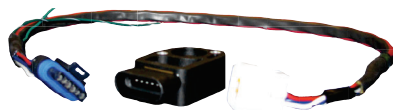

### Command Link® Auto Trim Tab Retractor Interface

The trim tab retractor interface provides up to two engine analog tachometer outputs needed for some automatic trim tab retractors.

**MAR-6X6DA-C0-00**



### Command Link®/Command Link Plus® Multisensor

The multisensor is utilized to provide water depth, water temperature, and water speed information to the Command Link Plus display or Command Link® Gauges. This multisensor has only one plug to power the unit and send signals to the ECU. It is powered through the Command Link Plus network. (Kit Includes: In-Line Hub 6Y8-81920-11-00, 1 ft. Pigtail Harness 6Y8-82521-01-00, Adaptor Harness 6Y9-83553-60-00, Multisensor 6Y9-83688-00-00)

**MAR-3DCER-KT-00**



### Electronic Cooling Water Pressure Sensor

The water pressure sensor kit taps into the engine block's cooling passage and converts the pressure readings to an electrical signal that is sent to the engines' ECU. The ECU can then display this data on the tachometer. This sensor kit is optional for Command Link Plus® and Command Link®, and there are two types depending on model of the engine. These sensors plug into harness leads that are part of the engine's wiring harness. V8 engines come standard with a cooling water pressure sensor. (Replacement sensor: 6AW-8366B-10-00)

**Kit for F40-F115, VF90, VF115, and HPDI: 60V-8A4L0-1B-00**  
**Kit for F150-F250, 4.2L VMAX SHO®, and 4.2L Offshore: 69J-8A4L0-16-00**

## Command Link® and Command Link® Plus Accessories

### Thermostat Cover for VMAX SHO®

Allows the installation of sensor kit 60V-8A4L0-1A-00 on VMAX SHO® engines.

**4.2L - 6CE-12413-C0-9S**  
**VF150, and VF175 - 6DA-1241B-A0-9S**



### Electronic Speed Sensor

The speed sensor converts the water pressure from the lower units' pitot tube to a digital signal inside the Engine's ECU. The ECU then displays the speed on the speedometer. The kit contains all of the components necessary to connect the sensor to the pitot hose coming from the lower unit and one kit fits all. V8 outboards do not have speedo tube required for connection to this sensor. (Replacement Sensor: 6AW-8366B-01-00)

**60V-8A4L1-1C-00**



### Display Cover for Command Link® Displays

Protect your display with this stylish and durable cover.

**Command Link Plus® Display: 6Y9-87278-00-00**  
**6YC Display: 6YC-87278-00-00**  
**CL7 Display: 6YD-87278-00-00**  
**CL5 Display: 6YM-87278-00-00**



### Remote Variable Trolling RPM Switch Kit (VTS)

With this new switch, increased VTS functionality is at your fingertips by adjusting the RPM without the gauge. The switch is compatible with F25C, F30 through F115 and VF115 (remote control models only). This helm-mounted remote switch connects to tiller handle input on the outboard. A brand new way to make fishing (and boating) easier at a low cost with huge benefits. The switch comes with a 26 foot harness length.

**MAR-VTSSW-00-KT**

**MAR-VTSSW-PN-L0**

*\*Panel with Screws*

**703-82117-00-00**

*Wire Lead*

**MAR-VTSSW-00-00**

*Remote Variable RPM switch*



## Conventional Harnesses

### Main Harness

The main harness is used to connect the engine to the electrical part of conventional controls. Available in both 7 Pin and 10 Pin configurations. 7 Pin harnesses do not contain the wires for power trim and tilt.

<b>7 Pin</b>	<b>16.4 ft.-</b>	<b>688-82586-51-00</b>
<b>10 Pin</b>	<b>16.4 ft.-</b>	<b>688-8258A-50-00</b>
<b>10 Pin</b>	<b>19.7 ft.-</b>	<b>688-8258A-60-00</b>
<b>10 Pin</b>	<b>23 ft.-</b>	<b>688-8258A-70-00</b>
<b>10 Pin</b>	<b>26.6 ft.-</b>	<b>6K1-8258A-41-00</b>
<b>10 Pin</b>	<b>31.2 ft.-</b>	<b>61B-8258A-02-00</b>



### Main Harness Extension

The harness extension is used to connect the engine to the main harness, perfect for those special applications.

<b>7 Pin</b>	<b>6.6 ft.-</b>	<b>688-82586-12-00</b>	<b>10 Pin</b>	<b>9.8 ft.-</b>	<b>688-8258A-30-00</b>
<b>10 Pin</b>	<b>6.6 ft.-</b>	<b>688-8258A-10-00</b>			



### 703 Control Box Main Harness

The replacement main harness for the 703 control box has the standard engine connection on one end and bullet connectors on the other. Both the 7 and 10 pin harnesses are 16 feet in length.

<b>7 Pin</b>	<b>688-82586-21-00</b>	<b>10 Pin</b>	<b>688-8258A-20-00</b>
--------------	------------------------	---------------	------------------------



### Dual Fuse Gauge Harness

Used to connect conventional gauges to key one power, battery positive, and other important sources. 10 ft.

**6Y5-83553-N1-00**

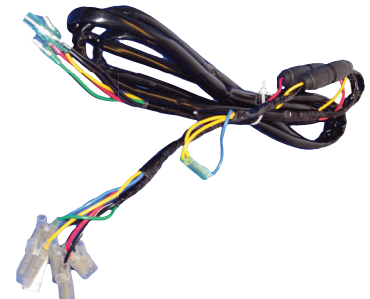

## Conventional Harnesses

### 7 to 10 Pin Adaptor Harness

The 7-10 Pin harness is used to connect 7 Pin engines to 10 Pin main harnesses. 1.6 ft.

**703-8258A-01-00**



### 2005 and Later Trim and Oil Harness

Used on outboards to transfer information to conventional gauges. One white 4 pin connection on each end.

<b>16.4 ft.- 6Y5-83653-00-00</b>	<b>26.3 ft.- 6Y5-83653-30-00</b>
<b>19.7 ft.- 6Y5-83653-10-00</b>	<b>30 ft.- 6Y5-83653-40-00</b>
<b>23 ft.- 6Y5-83653-20-00</b>	<b>35 ft.- 6Y5-83653-50-00</b>



### 2004 and Prior Trim and Oil Harness

Used on outboards to transfer information to conventional gauges. Two white 4 pin connection on each end.

<b>16.4 ft.- 68F-82553-50-00</b>	<b>26.3 ft.- 68F-82553-80-00</b>
<b>20 ft.- 68F-82553-60-00</b>	<b>31.2 ft.- 68F-82553-90-00</b>
<b>23 ft.- 68F-82553-70-00</b>	<b>32.8 ft.- 68F-82553-A0-00</b>



### Trim Harness

Used to transfer the trim signal to aftermarket gauges on 2004 and prior outboards. One white 4 pin connection on each end.

<b>10 ft.- 6R3-82553-30-00</b>	<b>26.3 ft.- 6R3-82553-80-00</b>
<b>16.4 ft.- 6R3-82553-50-00</b>	<b>31.2 ft.- 6R3-82553-90-00</b>
<b>23 ft.- 6R3-82553-70-00</b>	

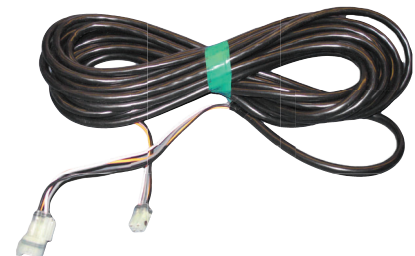

### Oil Tank Harness

Used on two stroke outboards to connect the remote oil tank with one blue 4 pin connection on each end.

<b>9.8 ft.- 6R3-85721-30-00</b>	<b>26.3 ft.- 6R3-85721-80-00</b>
<b>16.4 ft.- 6R3-85721-50-00</b>	



General Information

Rigging Estimate Guide (Diagrams)

Rigging Components

**Electrical Components**

Engine Accessories

Propellers

Maintenance Items

Yamaha & Trailer Supplies

Accessories & Apparel

## Conventional Harnesses



### Fuel Management Harness

Multifunction gauge to fuel flow sender and tank sender. Can connect up to two fuel flow senders.

**26 ft.- 6Y5-83553-F1-00**

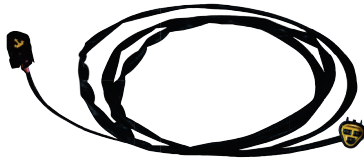

### Fuel Flow Sender to Wire Harness Extension

Installs between a fuel sender and the fuel sender harness to accommodate longer runs. 9.8 ft.

**6X1-82531-00-00**



### Wire Extensions Bullet Connector

If more than one instrument is used, additional jumpers will be required. These are available color coded to match the gauge harness. 1 foot in length and available in black, blue, and yellow.

**Black: 6Y5-82117-00-00**

**Yellow: 6Y5-82521-00-00**

**Blue: 6Y5-82149-00-00**



### 2 Pin Connector to Bullet Connector Adaptor

For use on 64D stop lanyard

**Female 2 Pin to 2 Male Bullet Connectors: 6X3-81971-00-00**

**Male 2 Pin Connector to 2 Female connectors: 6X3-81971-10-00**



### Multifunction to GPS Harness

Connects the multifunction speedometer to a GPS input.

**6Y5-87122-S0-00**



### Tachometer Harness

For applications with no remote control or a 701 control box. 16.4 ft.

**6Y5-83553-10-00**



### Extension Harness for remote mount PTT Switch

Three lead bullet connector extension 6.6 ft.

**6H5-82553-00-00**

## Conventional Harnesses

### Yamaha Main Harness to Aftermarket Control Box Connector

The sub harness is used to connect the 10 pin harness to an aftermarket control box. It includes the connections for PTT and neutral safety switch.

**704-82541-10-00**



### Aftermarket Main Harness to Yamaha Control Connector

This harness connects an aftermarket main harness to a 704 control box.

**704-85721-00-00**

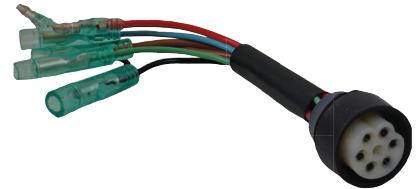

### Oil Tank Adapter Harness Square Female to Round Male

Used on 2 stroke engines with an in boat tank to connect the Trim and Oil Harness and oil tank harness.

**6R3-82541-00-00**

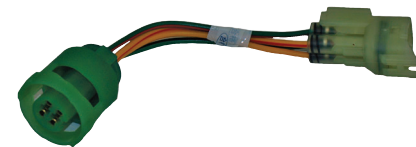

### Oil Tank Adapter Harness Square Male to Round Female

Used on 2 stroke engines with an in boat tank to connect the Trim and Oil Harness and oil tank harness.

**6R3-82541-10-00**



### Tachometer Adapter Harness

Adapter for one lead tach (-90) to 2004 and prior engines.

**6Y5-85335-10-00**



### Tachometer Adapter Harness

Adapter for two lead Tach (-82) to 2005 and later engines.

**6Y5-85335-00-00**



## Conventional Harnesses

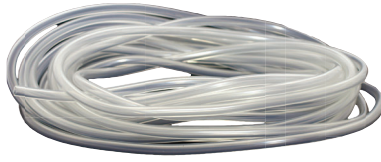

### Speedometer Tubing

For connecting analog signal speedometers to the speed pick up.

**30' length: 6Y5-83557-10-00**

**300' length: 6Y5-83557-40-00**



### Water Temperature Sender

Two wire sender for cooling water temperature gauges.

**688-83591-00-00**

## Conventional Accessories

### Yamaha Engine Meters

To help you maintain your generator at proper service intervals, the intervals are pre-programmed into this meter (10 hours initial, every 50 hours thereafter). Upon reaching the specified service interval, the meter displays a flash alert for a two-hour period.

**Deluxe Hour Meter (Hour Meter Only):** *ENG-METER-2C-01*

**Deluxe Hour Meter & Tachometer:** *ENG-METER-4C-02*



### Water Pressure Adaptor

Provides most Yamaha Outboards a water-jacket tap with a hose barb to adapt aftermarket pressure gauges which use a 1/8" ID (3/16" OD) rubber hose.

**MAR-WPRES-AD-TR**

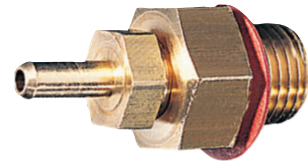

### Water Pressure Sender

Includes water jacket tap, hose, and nuts for installation on most Yamaha Outboards. (Ferrule and Nut 663-83668-00-00, Gasket 90430-14115-00 for gauge side)

\*Included hose is 32.8 ft. in length

**688-83667-01-00**

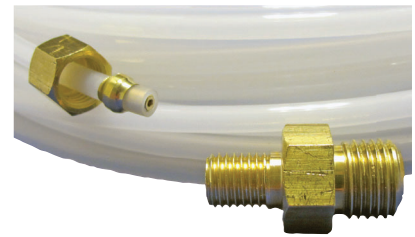

### Speedometer Pickup Sender

The speedometer pick up can assist in high-performance applications, where the engine is mounted at elevated levels, or with the Yamaha V8 outboards without a speed pick up in the lower unit.

**688-83556-00-00**



### Fuel Flow Sensor

Replacement sensor for use with Yamaha's fuel management and speed/fuel gauges.

**6Y5-85752-02-00**





## Charging, Starting, and Battery Cables

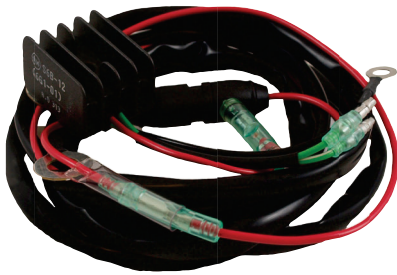

### Rectifier Kit

For manual start models with a lighting coil. May require additional parts: Washer 92990-06600-00, screw 98580-05525-00, and Bolt 97013-06010-00.

**676-81970-02-00**

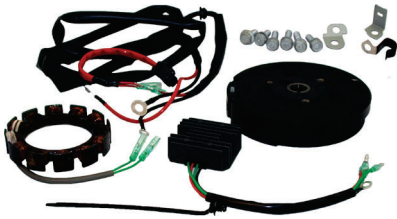

### F6/F4 Charge Kit

Allows the customer to have voltage output from the engine. For use on current F4 and F6 engines.

**6EE-762A0-00-00**



### Lighting Coil Extension Harness

Allows regulators and rectifiers to be mounted outside of the cowl in cases where electrical parts or portable engines may need to be removed for storage.

**682-84380-00-00**



### Battery Isolator Leads

With 50A Circuit Protection 13.5 ft:

**MAR-69JIS-0L-ED**

Without Circuit Protection 12 ft:

**69J-81949-03-00**

For use on 2.8L outboards

4.2 L 100A Circuit Protection 14 ft:

**MAR-6CEIS-1L-ED**

(Includes circuit breaker and 14 ft. lead to battery)

4.2L without Circuit Protection:

**6KW-81949-00-00**

(Includes connection for outboard and ring terminal)

With 200A Breaker 12ft:

**MAR-6GRIS-LE-D0**

With Cable, Washer, Nut No Fuse 12ft:

**6GR-762W0-01-00**

## Charging, Starting, and Battery Cables

### 4 Stroke F6 (~04/06)\*, F8, F9.9 (04/08~) Electric Start Kit

Convert a manual start engine into electric start. F6 will require additional parts listed below.

**6DR-W8180-13-00**

\* Requires additional parts listed below.

QTY	Description	Part Number
1	Starter Motor Bracket	68T-81822-01-00
2	Bolt	97013-08055-00
3	Washer	92990-08600-00
1	Bolt	97014-08040-00
1	Clamp	90465-10098-00
1	Clamp	90465-08M99-00
1	Bolt	97080-06012-00
1	Washer	92990-06600-00



### F25C Electric Start Kit

Convert a manual start engine into electric start.

**6FM-W8180-03-00**



### Battery Engine Cables

Used to connect Yamaha Outboards to 12 V batteries.

#### 2 Stroke Battery Cables

40-50	7.3ft.	63D-82105-J1-00
60,70, 90	7.8 ft.	6H0-82105-J3-00
115	9.4 ft.	6R3-82105-J3-00
V6 Carb	8.5 ft.	64D-82105-02-00
V6 EFI	8.7 ft.	67H-82105-01-00
2.6L HPDI	8.6 ft.	68F-82105-01-00
3.3L Z	11.2 ft.	60V-82105-01-00
3.3L VZ	8.1 ft.	60X-82105-01-00

#### 4 Stroke Battery Cables

F25C	6.6 ft.	6FM-82105-01-00
F50-F60	7.3 ft.	6C5-82105-U2-00
F75-F115	9.3 ft.	68V-82105-J2-00
VF115		68V-82105-02-00
F150	8.6 ft.	63P-82105-01-00
VF150/175/200		6DA-82105-02-00
F200/F225*	11.2 ft.	69J-82105-01-00
VF200-250	11.5 ft.	6CB-82105-03-00
F250 (3.3L)	11.2 ft.	6P2-82105-03-00
V8	11.5 ft.	6AW-82105-02-00
4.2L V6	11.5 ft.	6CB-82105-03-00
V8 XF425/450	11.5 ft.	6GR-82105-02-00



## Switches and Indicators



### Pull Style Light Switch

Two position, On - Off switch with a classic look.

**688-82520-00-00**

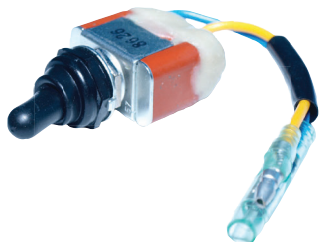

### On - Off Toggle Switch

Two position toggle switch with protective cover.

**688-82526-00-00**



### Remote Mount Trim Switch

Place trim/tilt functions right where you want them. Connects easily to main harness using the leads provided.

**688-82563-10-00**



### Lighting Rocker Switch

These high quality attractive switches are great for adding additional components to a customer's rig.

**F1C-U8026-00-00**



### Indicator Lamp

A durable red lamp with many useful purposes. Two lead connection.

**663-84301-01-00**



### 12 Volt Accessory Socket

Great for customers who like to use electronic gadgets or charge their cell phone on the water.

**F0K-U8284-00-00**

## Wire Connections and Circuit Protection

The wire connectors listed below are available through Marine Rigging and Parts. For a complete wiring kit, contact K&L Tools at 1-800-708-3184.

### Spade Connectors

Type	Size	Part Number	Minimum Order Qty.
Male	2.8 mm	90890-06432-00	10
Female	2.8 mm	90890-06433-00	10
Male	6.3 mm	90890-06434-00	10
Female	6.3 mm	90890-06435-00	10



### Bullet Connectors

Type	Sockets	Part Number	Minimum Order Qty.
Male	1	90890-05159-00	10
Female	1	90890-05160-00	10
Female	2	90890-06436-00	10



### Eye Connectors

Size	Part Number	Minimum Order Qty.
4 mm	90890-06438-00	10
6 mm	90890-06439-00	10
8 mm	90890-06440-00	10



### Insulators

Type	Part Number	Minimum Order Qty.
Male Bullet	90890-06441-00	10
Female Bullet	90890-06442-00	10
Twin Female Bullet	90890-06437-00	10



### Miscellaneous Connectors

Type	Part Number	Minimum Order Qty.
Butt connector	90890-06441-00	10
50 Pack Male Terminal Pins, trim and oil harness	90890-06442-00	1
50 Pack Female Terminal Pins, trim and oil harness	90890-06443-00	1



General Information

Rigging Estimate Guide (Diagrams)

Rigging Components

**Electrical Components**

Engine Accessories

Propellers

Maintenance Items

Yamaha & Trailer Supplies

Accessories & Apparel

## Wire Connections and Circuit Protection

The fuses and breakers listed here are for reference only. Always refer to PartsManager Pro™ for the correct protection for your engine application.



### Standard Blade Fuses

Amps	Part Number	Minimum Order Qty.
5	1NL-82151-00-00	10
7.5	2KW-82151-00-00	1
10	42X-82151-00-00	10
15	36Y-82151-00-00	1
20	2GV-82151-00-00	10
30	1AE-82151-00-00	1
40	5EA-82151-00-00	1



### Mini Blade Fuses

Amps	Part Number	Minimum Order Qty.
2	5JJ-82151-80-00	1
3	67F-82151-30-00	1
4	5JJ-82151-40-00	1
5	67F-82151-20-00	1
7.5	5JJ-82151-00-00	1
10	67F-82151-40-00	1
15	67F-82151-50-00	1
20	5JJ-82151-20-00	1
25	5JJ-82151-70-00	1
30	5JJ-82151-60-00	1



### 30 mm Glass Fuses

Amps	Part Number	Minimum Order Qty.
5	5G2-82151-00-00	10
10	1E6-82151-00-00	1
15	1UY-82151-00-00	1
20	682-82151-02-00	1
30	705-82151-01-00	1



### 20 mm Glass Fuses

Amps	Part Number	Minimum Order Qty.
7	27V-82151-00-00	10
10	1A0-82151-00-00	1
30	2H7-82151-00-00	10

## Wire Connections and Circuit Protection

### Breakers

Amp Rating	Part Number
3 amp	F1C-U8348-10-00
4 amp	F1C-U8348-20-00
5 amp	F1C-U8348-00-00
10 amp	F1C-U8348-30-00
Cover for Breaker (Screw on)	F0R-U8188-10-00

\*Insulated cover shown is sold separately

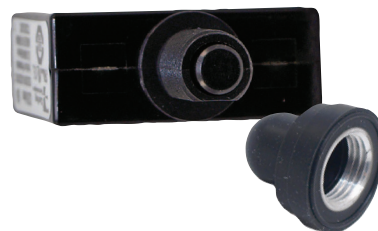

### Fuse Cartridges

Amps	Part Number	Minimum Order Qty.
50	63P-82151-00-00	1
60	6P2-82151-00-00	1
80	61A-82151-00-00	1
100	6CE-82151-00-00	1

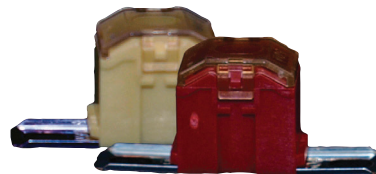

General Information

Rigging Estimate Guide (Diagrams)

Rigging Components

**Electrical Components**

Engine Accessories

Propellers

Maintenance Items

Yamaha & Trailer Supplies

Accessories & Apparel



<b>Description</b>	<b>Page</b>
Fuel System Components	5-1
2-Stroke Oil Systems	5-4
Rigging Tubes and Grommets	5-5
Steering System	5-6
Remote Control Attachment Kits	5-9
Cowling Covers	5-12
Engine Security	5-14
General Engine Accessories	5-15
Siren Marine®	5-18
Bennett Marine Common Replacement Parts & Accessories	5-19

General  
Information

Rigging Estimate  
Guide (Diagrams)

Rigging  
Components

Electrical  
Components

**Engine  
Accessories**

Propellers

Maintenance  
Items

Yamaha® &  
Trailer Supplies

Accessories  
& Apparel



## Fuel System Components



### 10-Micron Fuel/Water Separating Filter

They are a primary line of defense against ethanol-related fuel system issues. Highly recommended for all two stroke and four stroke EFI outboards and two stroke HPDIs. Also excellent for carbureted engines. New, improved 10-micron filter provides superior filtration ahead of the engine's onboard filters and injectors. Large filtering and water capture areas maximizing filtration while maintaining adequate flow rate for larger engines.

#### Assemblies

Assembly Stainless Steel Head **MAR-10MAS-10-00**

Assembly Stainless Steel Head 3/8" Fittings **MAR-10MAS-20-00**

Assembly Aluminum Head **MAR-10MAS-00-00**

#### Elements

Spin-On Filter Only **MAR-10MEL-00-00**

Bulk pack of 12 **MAR-10MEL-00-BK**

#### Filter Heads

Aluminum Filter Head 12 Pack **MAR-FLTHD-00-BK**

Stainless Steel Filter Head 12 Pack **MAR-FLTHD-10-BK**

Stainless Steel Filter Head 3/8" Fittings 12 Pack **MAR-FLTHD-20-BK**

#### Mini-10™

Assembly Aluminum Head **MAR-M10AS-00-00**

Spin-On Filter only **MAR-M10EL-00-00**

#### Brass Plugs

1/4" Brass Plug (fits all except 3/8") **MAR-BRASP-LG-14**

3/8" Brass Plug **MAR-BRASP-LG-38**

### Yamaha Remote Filter

Spin-on element bowl and water sensor probe. Requires Yamaha Multifunction Fuel Management Gauge for water detection indication.



#### Assemblies

#### Filter Bowls

Replacement Water Probe **MAR-10171-30-00**



### Portable Gas Tank

Meets Environmental Protection Agency (EPA) regulations that became effective January 1, 2011.

25 Liter (6.6 gallon) **6YK-24201-44-00**

12 Liter (3.1 gallon) **6YL-24201-24-00**

\* For above deck use only

## Fuel System Components

### Replacement Fuel Tank Parts for EPA Style Tank

Filler Cap with Gasket **6YL-24610-10-00**

Filler Cap Gasket Only **6YL-24641-10-00**

Filler Cap Lock Ring **6YL-24629-00-00**



### Replacement Fuel Tank Parts for Pre-EPA Fuel Tank

Filler Cap Gasket for both 6.6 and **MAR-COMBI-GS-KT**  
3.1 Gallon Tanks

Pick Assembly for 3.1 Gallon Tank **97951-24261-00**

Pick Assembly for 6.6 Gallon Tank **97951-24262-00**



### Yamaha Fuel Line Assemblies

Fuel line built to last. Your engine doesn't run without fuel, so make sure it has a steady supply. Yamaha's fuel line is built to strict standards and meets EPA regulations.

Inside Diameter	Engine Side Connection	Tank Side Connection	Length	Part Number
8mm	Conventional	Conventional	9.8 ft	6YK-24306-64-00
6mm	Conventional	Conventional	9.5 ft	6YL-24306-64-00



### Yamaha Fuel Line

8mm Fuel line only. Primer bulb and connections are not included. Yamaha's fuel line is built to strict standards and meets EPA regulations.

Application	Length	Part Number
F150	3.5 ft	63P-24316-21-00
F200, F225, F250	3.5 ft	6P2-24314-11-00
F75 / F90 / F115	4.3 ft	90445-13025-00
115 / V150 / HPDI	8.9 ft	90445-13016-00



### Yamaha Bulk Fuel Line

6mm and 8mm 30M Fuel line. Primer bulb and connections are not included. Yamaha's fuel line is built to strict standards and meets EPA regulations.

Diameter	Length	Part Number
6mm	98 ft	90798-1M599-00
8mm	98 ft	90798-1M598-00

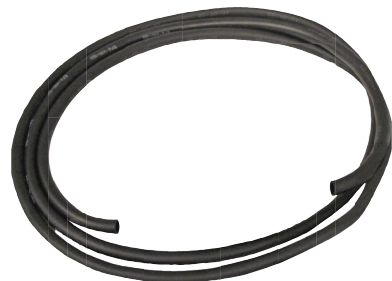

\*Yamaha recommends the use of these size Oetiker® clamps for these fuel lines  
11.5mm to 14mm for 6mm fuel line/13.2mm to 15.7mm for 8mm fuel line

General Information

Rigging Estimate Guide (Diagrams)

Rigging Components

Electrical Components

Engine Accessories

Propellers

Maintenance Items

Yamaha & Trailer Supplies

Accessories & Apparel

## Fuel System Components

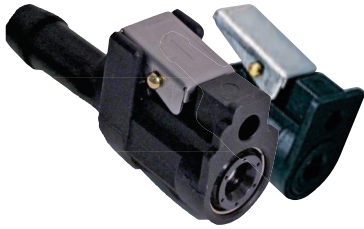

### Fuel Line Connections

Connection Description	Style	6mm Part Number	8mm Part Number
Hose Mounted Tank Side	Conventional	6Y1-24305-06-00	6Y2-24305-06-00
Hose Mounted Engine Side	Conventional	6G1-24305-05-00	6E5-24305-06-00



### Primer Bulbs

Size	Application	Part Number
8mm	F70~F225, 2-S 115~V150 & HPDI	6YK-24360-73-00
8mm	XTO, F350, F300, F250, 4.2L Engines	6AW-24360-02-00
6mm	Portable Outboards	6YL-24360-63-00
6mm	F4 / F6 Under the Cowl	6BX-24360-10-00



### Miscellaneous Fuel Line Connections

Joints are used to connect two pieces of fuel line together. The plug is a great tool for plugging off open fuel line to prevent debris from entering the fuel line.

Description	Part Number
6mm to 8mm Joint (5 pack)	67F-24377-00-BK
8mm Joint	6R3-24377-10-00
Joint Cover	68V-24452-00-00
Plug	689-85547-01-00

## 2-Stroke Oil Systems

### Oil Deck Filler Kits

Threaded reduction fitting with deck plate and “keyless” screw-on cap. Has restrictor and oil label to deter someone from accidentally filling your oil tank with gasoline. Angled version swivels for a precise fit. Uses 1 1/2" ID oil-resistant hose (not included).

Straight Deck Fill **ABB-PLATE-DE-CK**

*Replacement Parts*

90 Degree Joint **6E5-24478-01-00**

O-ring **ABB-ORING-DE-CK**

Gasket **6E5-24482-00-00**



### Remote 2.8 Gallon Oil Tank Kit

All the required parts to install a remote oil tank in one easy to order kit.

**6YR-762A0-01-00**

Kit Includes:

Quantity	Description	Part Number
1	Oil Tank Sub Assy (10.5L)	6E5-21733-30-00
1	Clamp	90465-13M11-00
1	Bracket, Damper Assy	6E5-21798-01-33
1	Hose Clamp Assy	90450-10M07-00
1	Nut	95380-06600-00
1	Clamp	90465-10098-00
1	Holder, Sub Oil Tank	6E5-21734-01-33
1	Bolt	97080-06100-00
1	Washer, Plain	92990-06600-00
1	Oil Feed Pump	6E5-81900-01-00
1	Oil Level Gauge	6E5-85720-06-00
1	Primer Bulb Assembly	6AW-24360-02-00
1	Oil Line	90445-11M00-00



## Rigging Tubes and Grommets



### Transom Fitting for Rigging Hose

An easy install. Just thread the Rigging Hose onto the fitting. Requires no clamp, yet provides positive engagement. Use with Rigging Grommet (sold separately) for quick, easy rigging.

2" Black	<b>MAR-THRUT-RS-M2</b>
2.5" Black	<b>MAR-TFLNG-25-BK</b>
2" White	<b>MAR-FLNG2-0W-T0</b>
2.5" White	<b>MAR-TFLNG-25-WT</b>
2.0" Chrome	<b>ABA-THRUT-RA-SM</b>



### Rigging Grommet

Choose the grommet for your engine. Simply thread the Rigging Grommet onto the Rigging Hose and thread the Transom Fitting (sold separately) onto the other end. Provides positive engagement without clamps.

F75-F115, 2-Stroke 115-250 **MAR-GROMM-ET-01**

F150 **MAR-GRMMT-F1-50**

F200-F250 **MAR-GRMMT-LG-4S**

*Other '02 ~ V4 and V6 models include the main grommet, but requires the following hardware to attach the rigging hose.*

*Fastener **68F-42753-00-00***

*Clip **90601-20022-00***



### Rigging Hose

High-quality hose is flexible, crush-resistant with UV inhibitors for added protection. Black, Gray, or Metallic Blue.

25' Black 2" (one roll)	<b>MAR-RIGHS-BK-25</b>
25' Black 2.5" (one roll)	<b>MAR-RHS25-BK-25</b>
100' Black 2" (two 50' rolls)	<b>MAR-RIGHS-BK-50</b>
100' Black 2.5" (two 50' rolls)	<b>MAR-RHS25-BK-50</b>
25' Gray 2" (one roll)	<b>MAR-RIGHS-GY-25</b>
100' Gray 2" (two 50' rolls)	<b>MAR-RIGHS-GY-50</b>
25' Metallic Blue 2" (one roll)	<b>ABB-RIGHS-BE-25</b>
25' White 2" (one roll)	<b>MAR-RHS20-WT-25</b>
25' White 2.5" (one roll)	<b>MAR-RHS25-WT-25</b>
100' White 2" (two 50' rolls)	<b>MAR-RHS20-WT-50</b>
100' White 2.5" (two 50' rolls)	<b>MAR-RHS25-WT-50</b>

*\*F300B - 2.0" ; XF425 - 2.5"*

## Steering Link Arm Kits

Connects Yamaha outboards to the boat's steering system. Some Yamaha outboards will come with a steering link arm kit in the crate. Please refer to the latest Product Information Guide for more details.

2-Stroke Model	Steering Guide Kit
9.9 / 15	63V-61350-00-00
25 / 30	689-61350-02-00
40 / 50 (~1995)	689-61350-02-00
40 / 50 (1996~)	63D-61350-00-00
60 - 90	688-61350-10-00
115 - 300	6E5-61350-02-00
4-Stroke Model	Steering Guide Kit
F8 (~04/2006)	68T-61350-00-00
F8 (04/2007~)	68T-61350-10-00
T8	68T-61350-00-00
F9.9 (~04/2005)	6G8-61350-00-00
F9.9 (2)	63V-61350-00-00
F9.9F	68T-61350-10-00
T9.9 (~04/2005)	6G8-61350-00-00
T9.9(2)	63V-61350-00-00
T9.9B	68T-61350-10-00
F15	63V-61350-00-00
F15C / F20	6AH-61350-00-00
F25 (~04/2005)	65W-61350-00-00
F25C / T25C	6BG-61350-00-00
T25 (~04/2006)	65W-61350-00-00
F30	65W-61350-00-00
F40 (1999)	63D-61350-00-00
F40 (2000~)	65W-61350-00-00
F40A	6BG-61350-00-00
F50 / T50 (1996~2004)	63D-61350-00-00
F50 / T50 (2005~)	65W-61350-00-00
F60 / T60	65W-61350-00-00
F70	65W-61350-00-00
F75 - F100	67F-61350-00-00
F115B (2014~)	6EK-61350-00-00
F115 - F300 (V6)	6E5-61350-02-00

## Steering System



## Steering System

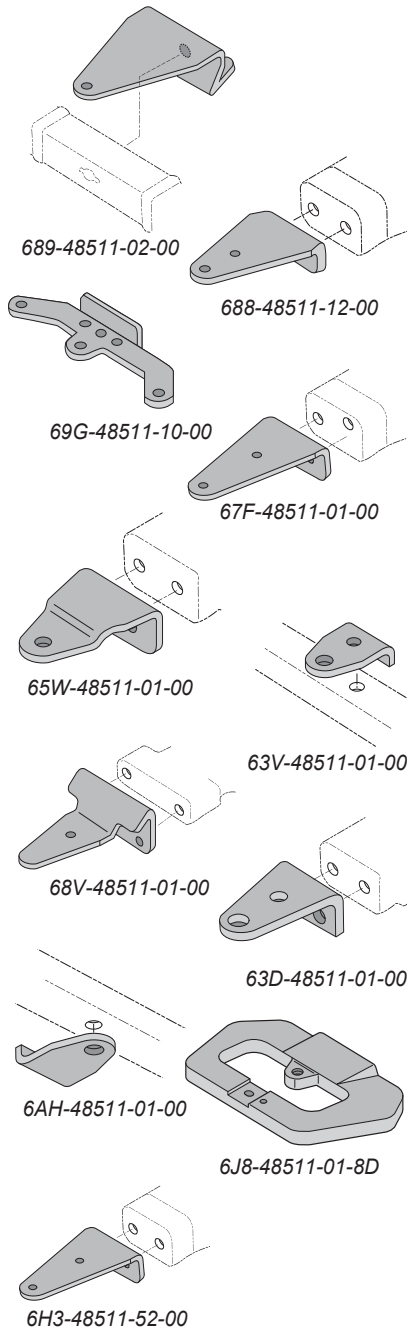

### Steering Hooks

Used to attach the steering arm to the outboard. Will require bolts or studs, nuts and washers to install. Please refer to PartsManager Pro™ for additional part numbers required.

2-Stroke Model	Steering Hook
9.9 / 15	99999-02878-00
25 (1989-1993), C40, CV40	689-48511-02-00
25 (2001, 2005-2007), 30 (2001)	6J8-48511-52-00

2-Stroke Model	Steering Hook
40, C40, 50, C50	63D-48511-01-00
60, C60, 70, C70	6H3-48511-52-00
90, B90, C75, C85, C90	688-48511-12-00

4-Stroke Model	Steering Hook
F8	63V-48511-01-00
T8 (2001)	63V-48511-01-00
T8 (except 2001)	69G-48511-10-00
F9.9-2, F9.9 (04/2006~)	63V-48511-01-00
T9.9G, T9.9A	69G-48511-10-00
T9.9 (~04/2005)	6G8-48511-20-00*
T9.9-2	63V-48511-01-00
F15	63V-48511-01-00
F15C	6AH-48511-01-00
F20	6AH-48511-01-00
F25	65W-48511-01-00
T25	65W-48511-01-00
F30	65W-48511-01-00

4-Stroke Model	Steering Hook
F40 (1999)	63D-48511-01-00
F40 (~2000)	65W-48511-01-00
F50 (~2004)	63D-48511-01-00
F50 (2005~)	65W-48511-01-00
T50 (~2004)	63D-48511-01-00
T50 (2005~)	65W-48511-01-00
F60	65W-48511-01-00
T60	65W-48511-01-00
F70	65W-48511-01-00
F75A	67F-48511-01-00
F80	67F-48511-01-00
F90A	67F-48511-01-00
F100	67F-48511-01-00
F115 (06/2011~)	68V-48511-01-00
F75B / F90B, F115B	688-48511-02-00

\*Discontinued

## Steering System

### Dual Steering Cable Bracket

Strong, 7-gauge stainless construction, with aluminum steering tube. Conforms to ABYC® standards. Features a steel shield over the steering tube to provide additional protection. Fits 70–300hp engines.

**ABA-DUALS-TE-ER**

Replacement Tube (not shown) **ABA-DUALS-TR-01**

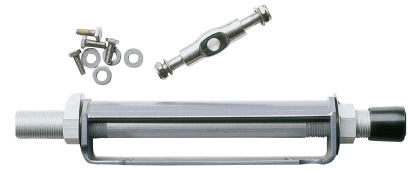

### Universal Dual Steering Bracket

Pre-drilled to fit all major outboard motor brands. Features an aluminum steering tube and stainless steel bracket. Fits 70–300hp engines.

**ABA-42110-00-00**



### Dual Steering Tie Bar Kit

Strong, stainless steel tie bar provides dual engine steering control for Yamaha outboards. Adjustable from 11" to 36". Includes necessary hardware.

**ABA-DUALT-IE-BR**



### Outboard Steering Centering Clips

Outboard steering centering clips for use with front mounted hydraulic steering cylinders having an 8 inch total stroke length (side to side). Helps the outboard remain centered while trailered. The clips also help limit the load applied to the hydraulic system that may occur when an outboard is tilted and partially turned. The clips are quickly and easily installed over the hydraulic cylinder steering rods. Sold in pairs.

Black (Rubber): **MAR-CNTRC-LP-08**

Orange: **6ES-23326-00-00**

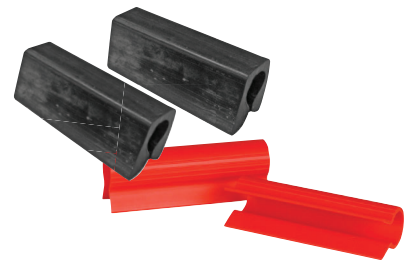

### Zerk Nut

Stainless steel, with high pressure O-ring seal. Attaches to steering tube to keep lubrication in, contaminants out.

**MAR-ZERKN-UT-01**



General Information

Rigging Estimate Guide (Diagrams)

Rigging Components

Electrical Components

Engine Accessories

Propellers

Maintenance Items

Yamaha & Trailer Supplies

Accessories & Apparel



## Remote Control Attachment Kits

The remote control kits listed below may also be listed with additional parts required to install the remote control attachment kits. For the most accurate information always refer to PartsManager Pro™.

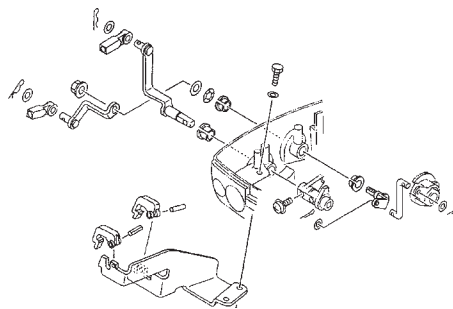

### 9.9/15 Outboards

Quantity	Description	Part Number
1	Throttle & Shift Kit	63V-48501-00-00
1	Steering Guide Attachment	63V-61350-00-00
1	Longer Steering Tilt Tube	63V-43131-10-00
1	Steering Hook	63V-48511-01-00
1	Bolt	97095-08035-00
1	Washer	92990-08600-00
1	Nut	688-48511-12-00

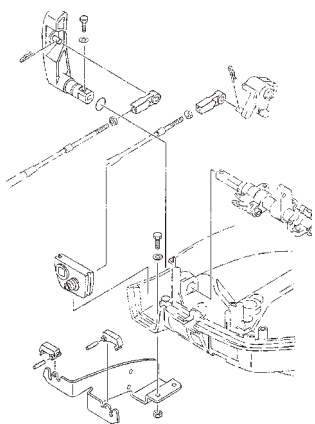

### F6/F8 Outboards

Quantity	Description	Part Number
1	Throttle & Shift Kit	6DR-48501-03-00
1	Steering Guide Attachment	68T-61350-00-00
1	Steering Hook	69G-48511-10-00
2	Bolt	97095-08035-00
1	Nut	95780-08300-00
1	Nut	90185-06M07-00
1	Wire Harness (For Connection to Control)	69G-82590-01-00

### F/T9.9 Models 85~06 1st Generation Outboards

Quantity	Description	Part Number
1	Throttle & Shift Kit	6G8-48501-03-00
1	Steering Guide Attachment	6G8-61350-00-00
1	Steering Hook (Steering Guide Type)	6G8-48511-20-00*
1	Steering Hook (Ball Post Type)	6G8-48511-10-00
2	Bolt	97D95-06016-00
2	Washer	92990-06600-00
1	Wire Harness (For Connection to Control)	6G8-82580-00-00

\*6G8-48511-20-00 Discontinued as of 02/2023

## Remote Control Attachment Kits

### F/T9.9, F15 Models 01~05 2nd Generation, F/T9.92 06~07 Outboards

Quantity	Description	Part Number
1	Throttle & Shift Kit (Comes with hook)	66M-48501-01-00
1	Steering Guide Attachment	63V-61350-00-00
1	Longer Steering Tilt Tube	63V-43131-10-00
1	Wire Harness (For Connection to Control)	66M-82590-10-00*

\*66M-82590-10-00 discontinued as of 11/2020

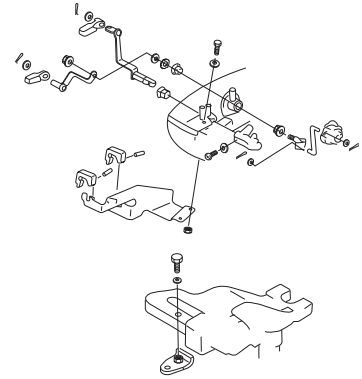

### F/T9.9G 08~ Outboards

Quantity	Description	Part Number
1	Throttle Shift Kit F/T9.9 08~	6DR-48501-03-00
1	Steering Guide Attachment	68T-61350-10-00
1	Steering Hook (F9.9 08~)	63V-48511-01-00
1	Steering Hook (T9.9 08~)	69G-48511-10-00
2	Bolt W/Washer	97E75-08535-00
1	Self-Locking Nut	95780-08300-00
1	Self-Locking Nut (For T9.9)	90185-06M07-00
1	Wire Harness (To Control For T9.9 Power Tilt)	69G-82590-01-00
1	Wire Harness (To Control For F9.9 Electric/Manual)	69G-82580-02-00

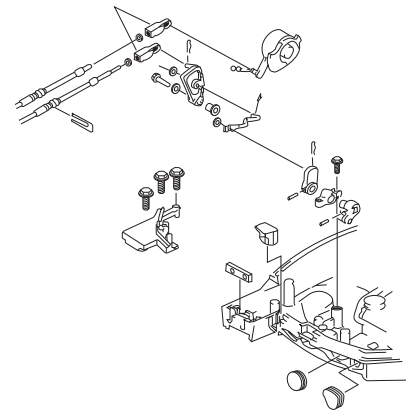

### F15C / F20 Outboards

Quantity	Description	Part Number
1	Throttle and Shift Kit	6AH-48501-02-00
1	Steering Arm	6AH-61350-00-00
1	Steering Hook	6AH-48511-01-00
1	Bolt	97095-08025-00
1	Washer	92990-08600-00
1	Nut	95780-08300-00
1	Cap	6AH-44194-00-00
1	Wire Harness	99999-04179-00
1	Steering Tube for F15C only	69A-43131-00-00

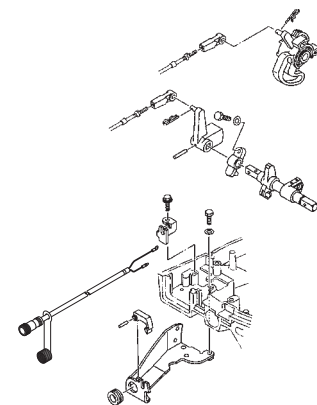

General Information

Rigging Estimate Guide (Diagrams)

Rigging Components

Electrical Components

Engine Accessories

Propellers

Maintenance Items

Yamaha & Trailer Supplies

Accessories & Apparel

## Remote Control Attachment Kits

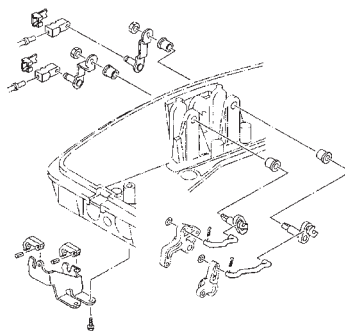

### 25E Outboards

Quantity	Description	Part Number
1	Throttle & Shift Kit	6L2-48501-11-00
1	Steering Guide Attachment Kit	689-61350-02-00
1	Steering Hook	6J8-48511-52-00
1	Wire Harness (For Connection to Control)	6L2-82590-00-00

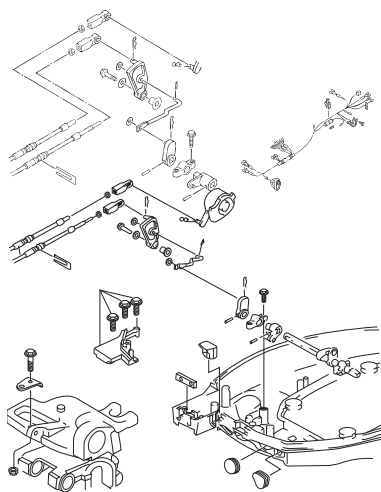

### F25 Models SE/SM/LE/LM 09~18 Outboards

Quantity	Description	Part Number
1	Throttle & Shift Attachment Kit (Comes with hook)	6BL-48501-02-00
1	Steering Guide Attachment	6BG-61350-00-00
2	Stud Bolt (For Hook)	90116-10064-00
1	Washer (For Hook)	92990-10600-00
1	Wire Harness SMHA/LMHA Models (To Control)	6BL-82590-20-00
1	Wire Harness SEHA/LEHA Models (To Control)	6BL-82590-20-00

### F25C Outboards

Quantity	Description	Part Number
1	Remote Control Attachment Kit	6FM-48501-02-00
1	Steering Friction for W Model	6FM-42508-12-00
1	Steering Friction for Non-PTT Models	6FM-42508-02-00

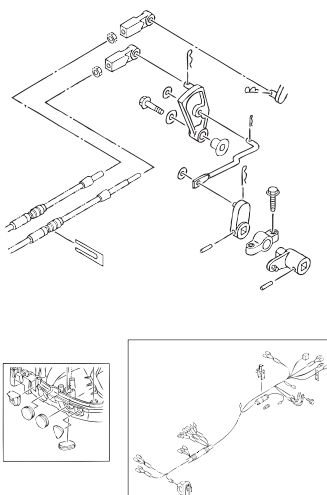

### F25 ~06 Outboards

Quantity	Description	Part Number
1	Throttle & Shift Attachment Kit (Comes with hook)	65W-48501-01-00
1	Steering Guide Attachment	65W-61350-00-00
2	Stud Bolt (For Hook)	90116-10063-00
2	Nut (For Hook)	90185-10027-00
1	Wire Harness EH Models (Connection to Control)	65W-82590-20-00*
1	Wire Harness MH Models (Connection to Control)	65W-82590-40-00

\*65W-82590-20-00 discontinued as of 11/2020

## Cowling Covers

Super heavy-duty protection for your Yamaha outboard's cowling. Constructed of ultra-durable Sur Last® solution dyed polyester fabric for the ultimate protection against fading and the elements, this non-abrasive, water resistant cover is resistant to UV, mildew and mold. The cover has a soft fabric inner liner for added paint protection, and screened on factory logos for unmatched style. Includes a snap-buckle strap and stretch cord for a snug fit.

V8 Application	Engine Cover	Lining
5.6L XTO Offshore Outboards	MAR-MTRCV-RX-T0	Yes
5.3L V8 Outboards	MAR-MTRCV-11-V8	Yes

V6 Application	Engine Cover	Lining
4.3L F350	MAR-MTRCV-R0-24	Yes
4.2L Offshore Outboards (B-Generation DEC)	MAR-MTRCV-F4-20	Yes
4.2L Offshore Outboards	MAR-MTRCV-F4-2L	Yes
3.3L F250 Outboards	MAR-MTRCV-11-25	Yes
3.3L F225 Outboards	MAR-MTRCV-11-00	Yes
3.3L F200 Outboards	MAR-MTRCV-11-00	Yes

F40 ~ F15C Application	Engine Cover	Lining
F40 Outboards	MAR-MTRCV-11-40	No
F30 Outboards	MAR-MTRCV-11-30	No
F20 Outboards	MAR-MTRCV-11-15	No
F15C Outboards	MAR-MTRCV-11-15	No

F200 ~ F50 Application	Engine Cover	Lining
F200 (Inline) / F150B / F175	MAR-MTRCV-F2-01	Yes
F150 / F200 w/Integrated Steering	MAR-MTRCV-R0-23	Yes
F150TXR / F150A Outboards	MAR-MTRCV-1C-15	Yes
F115 / F115B Outboards	MAR-MTRCV-11-50	No
F100 Outboards	MAR-MTRCV-11-50	No
F75 / F90B Outboards	MAR-MTRCV-F9-0B	No
F90A Outboards	MAR-MTRCV-11-50	No
F80 Outboards	MAR-MTRCV-11-50	No
F75 Outboards	MAR-MTRCV-11-50	No
F70 Outboards	MAR-MTRCV-FS-70	Yes
F/T50B / F/T60B	MAR-MTRCV-FS-70	Yes
T/F60 Outboards	MAR-MTRCV-11-80	No
T/F50 Outboards	MAR-MTRCV-11-30	No

Application	Engine Cover	Lining
VMAX® 200/225/250 Outboards (B-Generation)	MAR-MTRCV-SH-00	Yes
VMAX® 200 / 225/250 Outboards	MAR-MTRCV-ER-SH	Yes
175/150 VMAX SHO® Outboards	MAR-MTRCV-15-S1	Yes
115 VMAX SHO® Outboards	MAR-MTRCV-11-5S	No
VMAX 90 SHO® Outboards	MAR-MTRCV-VF-90	No

V6 Application	Engine Cover	Lining
VMAX HPDI 2.6L Outboards	MAR-MTRCV-11-10	Yes
VMAX HPDI 3.3L Outboards	MAR-MTRCV-1M-30	Yes
P, V, VX, D, DX 2.6L VMAX® Outboards	MAR-MTRCV-11-V6	Yes
VX VMAX® 3.1L Outboards	MAR-MTRCV-1M-20	Yes

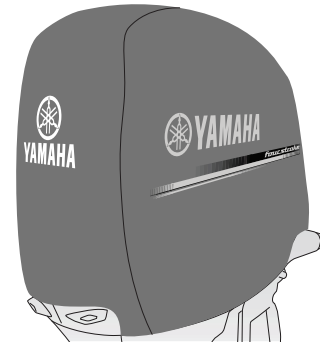

## Cowling Covers



Application	Engine Cover	Lining
S, SX, L, LX 150 - 250 Outboards	MAR-MTRCV-11-SS	Yes

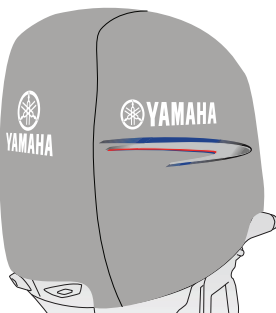

Application	Engine Cover	Lining
HPDI 2.6L Outboards	MAR-MTRCV-11-11	Yes
HPDI 3.1L Outboards	MAR-MTRCV-11-20	Yes

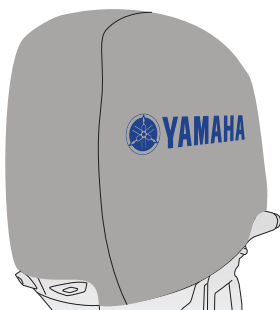

Application	Engine Cover	Lining
150 - 200 2 Stroke Outboards	MAR-MTRCV-ER-70	No
115 - 130 2 Stroke Outboards	MAR-MTRCV-ER-60	No
C75 - 90 2 Stroke Outboards	MAR-MTRCV-ER-40	No
30 - 70 2 Stroke Outboards	MAR-MTRCV-ER-20	No
6 - 25 2 Stroke Outboards	MAR-MTRCV-ER-10	No
F25C / T25C	MAR-MTRCV-F2-5C	No
F25 Outboards	MAR-MTRCV-ER-20	No
F4 - F15 Outboards	MAR-MTRCV-ER-10	No



Description	Cover
Tuning Fork Logo Spare Tire Cover	MAR-TIREC-OV-ER
Skeeter® Logo Spare Tire Cover	MAR-TIREC-OV-SK
Propeller Cover	MAR-PROPB-AG-BK

## Cowling Covers Graphics



### F9.9 / T9.9 (01/13~) Cowling with VMAX SHO® graphics

The top cowling allows both engines to have matching graphics in applications where a kicker motor is used along with a VMAX SHO® V6 outboard. Fits 9.9hp engine with factory 6EA cowling.

**6EA-42610-V2-00**

## Engine Security

### McGard® Outboard Lower Unit Lock Bolt

The lock is designed to secure the lower unit to the mid-section of the outboard while in storage, on the trailer, or in use. A free-spinning collar turns if attacked by gripping tools, helping protect against costly lower unit theft. Simply replace one of the standard lower unit mounting bolts with a McGard® lower unit locking bolt. Use the included special key to remove the McGard® lower unit locking bolt when removal of the lower unit is required. Stainless steel, through hardened construction. Fits Yamaha outboards F75 - F350 without 5" extension.

**MAR-LWRUN-LK-00**



### McGard® Wheel Locks

McGard®'s easy to use, one-piece wheel lock functions like a regular lug nut, but requires a special key tool for installation and removal. Its design allows for an unlimited number of different computer generated lock and key patterns. This unique wheel lock system is continually being refined and improved upon. McGard® Locks are made right here in the United States to meet or exceed O.E.M. standards for safety and durability.

Single Axle Trailer (2 locking nuts): **MAR-TRLK7-40-42**

Dual Axle Trailer (4 locking nuts): **MAR-TRLK7-40-41**



### Prop Lock

Helps protect your propeller investment. Easy-to install and cost effective. Does not interfere with operation (i.e., motor can be used with a lock installed). Suitable for use on regular and counter rotating props.

115hp ~ V6 Outboards: **MAR-PRLK7-40-40**

40hp ~ 90hp Outboards: **MAR-PLOCK-KE-Y1**



## General Engine Accessories



### Engine Mounting Bolts

Application	Length	Part Number
25 - 40	100mm (3.9 in)	90101-12M37-00
25 - 90	95mm (3.7 in)	90101-12062-00
25 - 90	105mm (4.1 in)	90101-12063-00
75 - 200	115mm (4.5 in)	90101-12064-00
90 - 250	130mm (5.1 in)	90101-12065-00
115 - 300	150mm (5.9 in)	90101-12066-00
350 - 425	150mm (5.9 in)	90101-12067-00
350 - 425	170mm (6.7 in)	90101-12068-00
350	85mm (3.3 in)	90101-12051-00
350 - 425	110mm (4.3 in)	90101-12072-00
350 - 425	180mm (7 in)	90101-12073-00
350 - 425	200mm (7.9 in)	90101-12074-00
350 - 425	210mm (8.2 in)	90101-12069-00
350 - 425	230mm (9 in)	90101-12070-00

\*M12 Washer 90201-12426-00 (Qty 4), 90201-13M01-00 (Qty 8), M12 Nut 95380-12600-00 (Qty 8)  
see Info Exchange RP2020-009



### XTO Ram Tilt Motor Support

Trailer Motor Support with Yamaha Tuning Fork logo designed for XTO® only, requires two per engine.

**MAR-MTSPT-GR-00**

### Trailer Support For Single Trim Ram Models

Designed to work with T25 - F115B.

**MAR-MTSPT-SR-00**

**MAR-MTSPT-SM-00**

All integrated steering inline F150 / F200 DEC or Mechanical



### Trailer Support (Twin Trim Ram Models)

One Yamaha Motor Trailing Support will provide adequate support for the F115 - V6 four-stroke and all 70 - 300 two-stroke models while trailering. V8 models require two supports. The Yamaha Motor Trailing Support is quickly and easily installed over the port trim rod on F115 - F250 four-stroke and all 70 - 300 two-stroke models or both trim rods on the V8 models. Fits F115 - F350 Four-Stroke and all 70 - 300 Two-Stroke models with Power Trim and Tilt. Does Not work with new F115B.

**MAR-MTSPT-YM-10**



### Yamaha Transom plate

A great way to add style and show off your Yamaha Pride. Laser Etched with the Yamaha Logo.

F30A ~ V6,V4 outboards: **YME-09TP0-01-00**

V8 outboards: **YME-09TP1-01-00**

## General Engine Accessories

### Engine Flushers

Connects in seconds to a common garden hose to flush out harmful sand, salt, and other contaminants.

Application	Part Number
VZ225, VZ250, VZ300, V-MAX SHO®	MAR-FLUSH-ER-VF
3, 4, 5, 9.9, FT9.9, 15 and all jet drive	ABB-FLUSH-JD-00
6, 8, 25-Z300HP	ABB-MOTOR-FL-SH

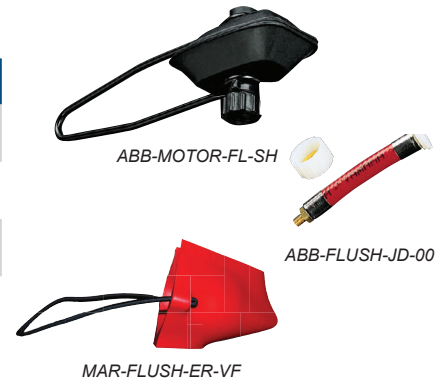

### Tilt Limiters

The tilt limiter for the new Yamaha Outboards was introduced to assist in customer satisfaction. The new limiter will help improve customer satisfaction in applications where the top cowling would come in contact with the boat at full tilt. Please select the correct tilt limiter from the charts below.

#### Tilt Limiter for Mechanical Controlled F115, F150, F200 (inline) & VMAX SHO® Outboards

Model	Serial Number Range	Part Number
4.2L Mechanical	All 4.2L Mechanical	63P-825EY-02-00
F115 / F115B / VF115	68V 1124466 / All F115B and VF115	63P-825EY-02-00
LF115 / LF115B	68W 1005001~ / All LF115B	63P-825EY-02-00
F150 / VF150 / F175 / VF175 / F200	63P 1106291~	63P-825EY-02-00
LF150	64P 1013389~	63P-825EY-02-00
VF200	6CD 1000832~	63P-825EY-02-00
VF225	6CC 1001056~	63P-825EY-02-00
VF250	6CB 1002436~	63P-825EY-02-00

#### Tilt Limiter for DEC Controlled 4.2L Offshore Outboards & F200 (inline) DEC Outboards

Model	Production Date Range	Part Number
F200 (inline) / F225	01/2012 ~	6CE-825EY-02-00
F250	01/2012 ~	6CE-825EY-02-00
F300	01/2012 ~	6CE-825EY-02-00

#### Tilt Limiter for F75, F90 Outboards

Model	Production Date Range	Part Number
F75	01/2012~	6D8-825EY-01-00
F90	01/2012~	6D8-825EY-01-00

#### Tilt Limiter for F50, T50, F60, T60, F70 Outboards

Model	Production Date Range	Part Number
F50	04/2012~	6C5-825EY-00-00
F60	04/2012~	6C5-825EY-00-00
F70	04/2012~	6C5-825EY-00-00





## General Engine Accessories

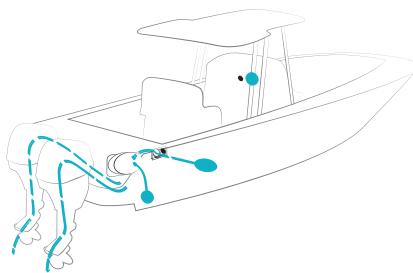

### Automatic Flushing System (All Models)

Connects in seconds to flush out harmful sand, salt, and other contaminants.

Application	Part Number
Single Engine Fitting Kit	MAR-FLSHF-T1-00
Twin Engine Automatic Flushing System	MAR-FLUSH-20-00
Twin Engine Fitting Kit	MAR-FLSHF-T2-00
Triple Engine Automatic Flushing System	MAR-FLUSH-30-00
Triple Engine Fitting Kit	MAR-FLSHF-T3-00
Quad Engine Automatic Flushing System	MAR-FLUSH-40-00
Quad Engine Fittings Kit	MAR-FLSHF-T4-00

### Flushing Installation Components

Component	Part Number
Remote Switch w/ 3' Harness Assembly	MAR-FLSHS-W6-00
Remote Switch w/ 9' Harness Assembly	MAR-FLSHS-W1-20
Remote Switch w/ 15' Harness Assembly	MAR-FLSHS-W1-80
Remote Switch w/ 19' Harness Assembly	MAR-FLSHS-W1-90
Inlet Hose Install Kit - 3'	MAR-FLSHH-S3-00
Inlet Hose Install Kit - 6'	MAR-FLSHH-S6-00
Inlet Hose Install Kit - 9'	MAR-FLSHH-S9-00
Quick Disconnect Deck Kit with 1/2" MNPT x 3/4" Hose Barb Straight Fitting	MAR-FLSHQ-D0-00
Quick Disconnect Deck Kit with 1/2" MNPT x 3/4" Hose Barb 90 degree Elbow	MAR-FLSHQ-D9-00
Quick Disconnect Mounting Kit - Standard	MAR-FLSQD-KS-00
Quick Disconnect Mounting Kit - 90 Degree Turn	MAR-FLSQD-K9-00
Quick Disconnect Mounting Kit - 180 Degree Turn	MAR-FLSQD-K1-80
Quick Disconnect Mounting Kit - 270 Degree Turn	MAR-FLSQD-K2-70
Quick Disconnect Mounting Kit - No Switch	MAR-FLSQD-K0-00
1/2" ID Bulk Flushing Hose 25' Roll	MAR-FLSHH-S2-50*

\*MAR-FLSHH-S2-50 Discontinued

**Note:** See [www.reversopumps.com](http://www.reversopumps.com) for more information.



Product	Part Number
<b>Siren 3 Pro</b>	
Siren 3 Pro, 917 MHz Band	6X8-85B11-02-00
<b>Siren 3 Pro Sensors</b>	
Wireless Sensor Siren 3 Battery	6X8-85B21-00-00
Wireless Sensor Siren 3 Bilge	6X8-85B23-00-00
Wireless Sensor Siren 3 Entry	6X8-85B24-00-00
Wireless Sensor Siren 3 High Water	6X8-85B22-00-00
Wireless Sensor Siren 3 Temperature	6X8-85B25-00-00
Sensor, Canvas Snap Cover	6X8-85B31-00-00
Sensor, Infrared Motion	6X8-85B32-00-00
Switch, Magnetic Reed	6X8-85B41-00-00
Sensor, Micro ePIR Motion	6X8-85B33-00-00
<b>Siren 3 Pro Accessories</b>	
SirenSat Offshore	6X8-85B82-00-00
Sensor Plug, Shore Power	6X8-85B34-00-00
Relay, AC Shore Power	6X8-85B51-00-00
AC Relay, 240v AC	6X8-85B52-00-00
Relay, DC Accessory	6X8-85B53-00-00
Audible Alarm	6X8-85B61-00-00
Blue Sea Systems® Battery Switch 7713	6X8-85B42-00-00
NMEA 2000® Cable and T Connector, S3P	6X8-82521-00-00
Wiring Cable 2, S3P	6X8-8356N-00-00
External GPS Antenna	6X8-85B81-00-00
Remote Cellular & GPS Antenna: Adhesive-Mount Puck	6X8-85B83-00-00
Remote Cellular & GPS Antenna: Threaded-Mount Dome	6X8-85B84-00-00
Wireless Battery Replacement	6X8-85B71-00-00



## Siren 3 Pro

### Siren Marine's Next Gen Technology

Welcome to the next gen tech – providing the ultimate Connected Boat® experience that keeps you connected 24/7 regardless of boat size, type or use. Together with our easy-to-use App & offering global cellular & optional satellite connectivity, our smart boat device connects you to your boat anywhere, anytime. Control your boat’s lights, A/C & digital switching systems from the palm of your hand.

Siren Marine provides remote monitoring, helping your boat stay safe, secure & ready to enjoy.

# Engine Accessories

## Bennett Marine Common Replacement Parts & Accessories

General Information

Rigging Estimate Guide (Diagrams)

Rigging Components

Electrical Components

Engine Accessories

Propellers

Maintenance Items

Yamalube & Trailer Supplies

Accessories & Apparel



**A1101A**  
6BT-50063-82-00



**A1103**  
6BT-50005-78-00



**A1109**  
6BT-50005-84-00



**A1113**  
6BT-50086-62-00



**A1115**  
6BT-50005-90-00



**A1117**  
6BT-50005-94-00



**A1120**  
6BT-50086-60-00



**ATPBOLCTRL**  
6BT-50011-08-00



**ATPDISP/ATPDISPBR**  
6BT-50011-12-00 / 6BT-50011-13-00



**ATPHYDCTRL**  
6BT-50011-19-00



**ATPSENSTD**  
6BT-50092-59-00



**BAW20**  
6BT-50011-80-00  
Available 5'- 20'  
(5' Increments)



**BEA2000**  
6BT-50012-02-00



**BEA2100**  
6BT-50012-07-00



**BRC4000**  
6BT-50017-40-00



**BXADAC10PD-NH-4N**  
6BT-50092-58-00



**EH1071**  
6BT-50035-12-00



**EIC001**  
6BT-50024-23-00



**EIC101 / EIC102**  
6BT-50024-27-00 / 6BT-50024-34-00



**EIC201**  
6BT-50024-47-00  
Available 20'- 40'  
(5' Increments)



**EIC301**  
6BT-50024-95-00



**EIC801**  
6BT-50026-78-00



**EIC901P / EIC901S**  
6BT-50086-71-00



**ES2000**  
6BT-50030-16-00



**H1170A**  
6BT-50085-94-00



**H1170B**  
6BT-50032-84-00



**H1174**  
6BT-50086-02-00



**H1175**  
6BT-50086-04-00



**H1176**  
6BT-50033-28-00



**H1178**  
6BT-50033-30-00



**H1179**  
6BT-50085-99-00



**JOY1000**  
6BT-50100-19-00



**OB19000E**  
6BT-50103-40-00



**PT950P**  
6BT-50051-07-00



**RM12 / RM24**  
6BT-50052-97-00 / 6BT-50053-02-00



**SEA3000**  
6BT-50111-72-00



**SSADAC10D-316**  
6BT-50109-60-00



**T112520**  
6BT-50063-64-00  
Available 10' - 50'  
(5' increments)



**T1126**  
6BT-50063-81-00



**T1127**  
6BT-50063-82-00



**VP1135G24V**  
6BT-50079-56-00



**VP1135R**  
6BT-50086-74-00



**VP1135R24V**  
6BT-50079-59-00



**VP1138**  
6BT-50086-63-00



**VP1139**  
6BT-50099-17-00



**VP1140**  
6BT-50099-18-00



**VP1141**  
6BT-50099-19-00



**VP1146**  
6BT-50079-71-00



**VP1154**  
6BT-50099-24-00



**VP1159**  
6BT-50086-64-00



**VP1160**  
6BT-50079-79-00



**VP1161**  
6BT-50079-79-00



**WH100022**  
6BT-50080-16-00

## Bennett Marine Common Replacement Parts & Accessories

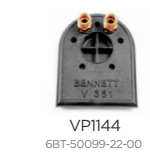
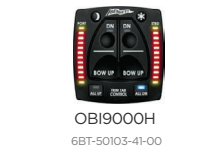

**Bennett Marine Support**  
1-866-894-1626 (Option 3)

A Division Yamaha Marine  
Systems Company, Inc.



Bennett PN	Yamaha PN	Description
A1101A	6BT-50063-82-00	Standard Length Hydraulic Actuator
A1103	6BT-50005-78-00	Hydraulic Upper Hinge with O-Ring
A1109	6BT-50005-84-00	Piston with O-Ring
A1113	6BT-50086-62-00	Hydraulic Actuator Lower Hinge
A1115	6BT-50005-90-00	Lower Hinge Pin
A1117	6BT-50005-94-00	Small Actuator Piston with O-Ring
A1120	6BT-50086-60-00	Actuator Upper Hinge O-Ring
A1121	6BT-50086-61-00	Actuator Piston O-Ring
A1200S	6BT-50084-79-00	Small Hydraulic Actuator
ATPBOLCTRL	6BT-50011-08-00	AutoTrim Pro Control Unit (Electric)
ATPDISP / ATPDISPBR	6BT-50011-12-00 / 6BT50011-13-00	AutoTrim Pro Helm Display
ATPHYDCTRL	6BT-50011-19-00	AutoTrim Pro Control Unit (Hydraulic)
ATPSENSTD	6BT-50092-59-00	AutoTrim Pro Standard Sensor Kit
BAW20	6BT-50011-80-00	20' Wire Harness
BEA2000	6BT-50012-02-00	Bolt Electric Actuator
BEA2100	6BT-50012-07-00	Bolt Actuator Uh Spacer
BEA3000	6BT-50012-09-00	Bolt Adjustable Actuator
BHW4010	6BT-50012-45-00	Helm Keypad Wire Extension - 10'
BRC4000	6BT-50017-40-00	Bolt Rocker Switch Control
BXADACIOPD-NH-4N	6BT-50092-58-00	BXA Premier Hydraulic Actuator
EH1071	6BT-50035-12-00	#10 x 1-1/4" Full Thread Screw
EIC001	6BT-50024-23-00	EIC Control/Display
EIC101 / EIC102	6BT-50024-27-00 / 6BT-50024-34-00	EIC Relay Module
EIC201	6BT-50024-47-00	EIC 20'
EIC301	6BT-50024-95-00	Wire Harness
EIC601	6BT-50025-49-00	EIC Bridge Hardware Pack
EIC701	6BT-50026-34-00	EIC Bridge Junction Box
EIC801	6BT-50026-78-00	EIC Bridge Wire Harness 20'
EIC901P / EIC901S	6BT-50086-71-00	EIC Upper Hinge with 10' Sensor Wire
ES2000	6BT-50030-16-00	Hydraulic Euro-Style Rocker Switch
H1170A	6BT-50085-94-00	Hydraulic Trim Tab Hardware Pack
H1170B	6BT-50032-84-00	Dual Actuator Hardware Pack
H1171(3-4)	6BT-50033-14-00	3' & 4" Pipe Nipples
H1172	6BT-50033-23-00	Female Elbow
H1174	6BT-50086-02-00	#14 x 1-1/2" Full Threaded Screw
H1175	6BT-50086-04-00	1/4 - 20 x 3/4" Machine Screw
H1176	6BT-50033-28-00	20 Amp Fuse
H1178	6BT-50033-30-00	Fuse Holder
H1179	6BT-50085-99-00	Mounting Bracket for HPU
JOY1000	6BT-50100-19-00	Joystick Helm Control
OBI9000E	6BT-50103-40-00	OBI Integrated Helm Control (Electric)
OBI9000H	6BT-50103-41-00	OBI Integrated Helm Control (Hydraulic)
PT109 / PT110	6BT-50050-99-00	Pigtail for Wire Harness / for HPU or Control
PT950P	6BT-50051-07-00	EIC Port Pigtail
RM12/ RM24	6BT-50052-97-00 / 6BT-50053-02-00	Relay Module 12V / 24V
SEA3000	6BT-50111-72-00	Short Electric Actuator
SSADACIOD-316	6BT-50109-60-00	SSA Premier Hydraulic Actuator
T112520	6BT-50063-64-00	Hydraulic Tubing 20'
T1126	6BT-50063-81-00	Brass Line Tee Fitting
T1127	6BT-50063-82-00	Nut with Ferrule
V351HPU1	6BT-50086-73-00	Hydraulic Power Unit
VP1135G	6BT-50079-55-00	Solenoid Valve 12V - Green Wire (Stbd.)
VP1135G24V	6BT-50079-56-00	Solenoid Valve 24V - Green Wire (Stbd.)
VP1135R	6BT-50086-74-00	Solenoid Valve 12V - Red Wire (Port)
VP1135R24V	6BT-50079-59-00	Solenoid Valve 24V - Red Wire (Port)
VP1138	6BT-50086-63-00	Lexan Cover
VP1139	6BT-50099-17-00	Fluid Reservoir
VP1140	6BT-50099-18-00	Filler Plug
VP1141	6BT-50099-19-00	Hex Retainer
VP1142	6BT-50099-20-00	Motor Strap
VP1144	6BT-50099-22-00	HPU Face Plate
VP1146	6BT-50079-71-00	1/8" Pipe to 1/4" Pipe Tube Connector
VP1154	6BT-50099-24-00	#8 x 3/4" Phil Pan Sheet Metal Screw
VP1159	6BT-50086-64-00	Valve Seat with O-Ring
VP1160	6BT-50079-79-00	HPU Valve Spring
VP1161	6BT-50079-79-00	HPU Valve Plunger
WH100022	6BT-50080-16-00	Standard 22' Wire Harness

General Information

Rigging Estimate Guide (Diagrams)

Rigging Components

Electrical Components

Engine Accessories

Propellers

Maintenance Items

Yamaha & Trailer Supplies

Accessories & Apparel



<b>Description</b>	<b>Page</b>
Propeller Quick Reference Chart	6-1
Yamaha Propeller Descriptions	6-3
XTO Propeller Descriptions	6-6
Turbo Propeller Descriptions	6-7
How to Pick a Propeller	6-10
Propeller Terminology	6-11
Propellers for Two Stroke 2-15, and Four Stroke F2.5-F20	6-14
F Series Propellers for 3.0" Gearcases	6-15
G Series Propellers for 3.5" Gearcases	6-15
K Series Propellers for 4.25" Gearcases	6-16
P Series Propellers for 4.25" and 4.75" Gearcases	6-18
M Series Propellers for 4.75" Gearcases	6-18
T Series Propellers for 4.75" Gearcases	6-19
X Series Propellers for 5.25" Gearcases	6-21
Y Series Propellers for 6.0" Gearcases	6-22
Small Hub Propellers for High Performance Applications	6-23
TRP (Twin Rotating Propellers) for TRP Gearcases	6-23
Sharrow MX3 V6 Propellers	6-24
Turbo Propellers for 3.0" ( <i>F Series</i> ) Gearcases	6-25
Turbo Propellers for 3.5" ( <i>G Series</i> ) Gearcases	6-25
Turbo Propellers for 4.25" ( <i>K Series</i> ) Gearcases	6-26
Turbo Propellers for 4.75" ( <i>M/T Series</i> ) Gearcases	6-27
Hubs for Yamaha Propellers	6-32
Hubs for Turbo Propellers	6-33
Turbo Hub Application Charts	6-34
Propeller Hardware Kits	6-43
Propeller Accessories	6-44

## Propeller Quick Reference Chart

With all Yamaha has to offer in regard to propellers, virtually any boat can perform at its peak, including yours. From large offshore boats to family and watersports boats to the fastest bass and bay boats, Yamaha has a propeller that's just right for your application.

Propeller Series		Recommended Boat Application		Engine/Gear Case Size														
				Yamaha Propeller Available Pitches														
Aluminum	Family, Water Sports, Medium, and Small Boats	8-14	8-17	11-25		15-23	17-19											
Painted Stainless Steel	Family, Medium, and Small Boats	12-13	11-16	14-25	17-21	13-25	15-23	17-21	17-21									
Performance 3	Family, Medium, and Small Boats	prop	12-15	14-24	14-22	14-26	14-22											
Dual Thrust	Family and Small Boats	8 1/4	9	11														
Talon®	Medium and Small Boats			9-16														
Talon GP®	Medium and Small Boats			14-18														
Talon SS®	Medium and Small Boats			14-24	14-20													
Talon® SS4	Medium and Small Boats			14-23														
Talon Pontoon®	Family, Medium, and Small Boats			9-13														
PRO	Bass, Bay, and Flats Boats					21-27												
Reliance®	Family, Medium, and Small Boats					13-21	14-21											
Saltwater Series® II	Family, Medium, and Large Boats							13-25	13-25									
Saltwater Series® II HP	Family, Medium, and Large Boats							18-21	18-21									
Saltwater Series HS4	Medium and Large Boats							21-23	21-23									
Performance 4	Bay, and Flats Boats							18-26										
V MAX SHO®	Bass, Bay, and Flats Boats							22-27										
Saltwater Series XL®	Medium and Large Boats									15-23	15-23							
Saltwater Series XL4	Medium and Large Boats									15-24	15-24							
XTO OS®	Medium and Large Boats															15-27	15-27	
XTO EC®	Medium and Large Boats															16-26	16-26	

## Propeller Quick Reference Chart

Propeller Series	Recommended Boat Application	Turbo Propeller Available Pitches					
		RH F25 and 20-30 (3.0" Gearcase)	RH T25, F30-F60 and 40-55 (3.5" Gearcase)	RH T50, T60, F70-F115 and C60-130 (4.25" Gearcase)	LH T50, T60, F70-F115 and C60-130 (4.25" Gearcase)	RH 150-300 and F150 - F350 (V6) (4.75" Gearcase)	LH 150-300 and F150 - F350 (V6) (4.75" Gearcase)
Fusion 4	Bass, Bay, Flats, and Large Boats					21-26	21-23
FX4	Bay, Flats, Medium, and Small Boats			14-25			
FXP™	Bass, Bay, and Flats Boats					22-27	
Hot Shot	Medium and Small Boats	10-15	10-19				
Lightning	Bass, Bay, and Flats Boats					17-21	
Offshore 1	Medium and Large Boats					15-26	15-26
Offshore 2	Medium and Large Boats					15-25	15-25
Pontoon 1	Family, Medium, and Small Boats		9-15	9-15			
Quest™ 3 Blade	Family, Medium, and Small Boats			15-21			
Quest™ 4 Blade	Family, Medium, and Small Boats			14-21			
Turbo® 1	Family, Medium, and Small Boats			13-23		13-25	15-21
Turbo 2+2	Bass, Bay, and Flats Boats					16-24	
Turbo 2+2OT	Bass, Bay, and Flats Boats					18-26	
TXP™	Bass, Bay, and Flats Boats					21-31	
TXP OT4	Bass, Bay, and Flats Boats					23-31	
Ultima 4	Bass, Bay, Flats, Medium, and Small Boats					13-23	13-23
Vector	Family and Water Sports					21-25	21-25

General Information

Rigging Estimate Guide (Diagrams)

Rigging Components

Electrical Components

Engine Accessories

**Propellers**

Maintenance Items

Yamaha & Trailer Supplies

Accessories & Apparel



## Yamaha Propeller Descriptions

### Endless Propeller Solutions By Yamaha

With all that Yamaha has to offer in regard to propellers, virtually any boat can perform at its peak. That includes yours. From large offshore boats to family and watersports boats to the fastest of bass and bay boats, Yamaha has a propeller solution that's just right for your application. Yamaha propeller solutions. Well beyond expectations.



#### Plastic Propellers

- Ideal for those who run in debris filled water.
- Available for the 2 HP two stroke or the T9.9 four stroke



#### Aluminum

- Low cost
- Lightweight
- Good all-around performance
- Wide variety of applications



#### Dual Thrust™

- Large diameter and large blade design
- Low pitch and rake angle
- Large oversized exhaust tube to redirect exhaust in reverse for better reverse thrust
- Perfect for sailboats and pontoons
- Designed for Yamaha High Thrust outboards and also works well on midrange outboards



#### Painted Stainless Steel

- Low Cost
- More durable than aluminum
- Wide variety of applications in left and right-hand rotation

## Talon

- Shift Dampener System (SDS®)
- High efficiency, low slip design
- Lightweight aluminum
- Excellent for Pontoon, Deep V, Walleye, and Fiberglass boats



## Talon SS

- Shift Dampener System (SDS®)
- High efficiency, low slip design
- Excellent for light bass, flats, and small to medium boats with mid-range power



## Talon GP

- Special blades provide excellent “grip” on the water
- Ideal for a variety of lighter weight boats
- Shift Dampener System (SDS®)



## Talon Pontoon

- Use on twin-log pontoon boats and some deck boats, sailboats, and utility/work boats where extra thrust, maneuverability, and control are needed.
- Ideal for many applications using Yamaha’s F70 outboard.
- Resists ventilation, particularly in turns and at high engine trim levels



## Talon SS4

- Special blades provide excellent “grip” on the water
- Ideal for a variety of lighter weight boats
- Shift Dampener System (SDS®)



## Performance 3

- Shift Dampener System (SDS®) M/T Series
- Excellent general purpose propeller
- More durable than aluminum
- Wide variety of applications in left and right-hand rotation



## PRO™

- Excellent performance choice for bass, bay, or flats boats
- Improved bow lift
- Vented exhaust





### Reliance

- Shift Dampener System (SDS®)
- CAD-designed to increase performance
- Resists ventilation and improves overall grip



### Performance 4

- Improved hole shot and overall grip
- Excellent in rough water or on applications requiring high engine mounting heights



### V MAX SHO®

- Ultimate performance for V MAX SHO® four stroke outboards
- Excellent for bass, bay, and flats boats
- Awesome acceleration and top speed
- Ventless exhaust
- Incredible performance and handling
- Right-hand rotation only



### Saltwater Series HS4™

- Shift Dampener System (SDS®)
- Excellent acceleration, quick planing, and maximum grip
- Resists ventilation in rough or following seas
- Designed for Yamaha V6 outboards



### Saltwater Series II

- Shift Dampener System (SDS®)
- Large diameter blade design
- Aggressive rake and extra cup
- Superior fuel efficiency



### Saltwater Series II HP

- This stainless-steel, three-blade propeller can boost top-end speed on lightweight center consoles, flat/bay boats and more.

## Saltwater Series XL

- Shift Dampener System (SDS®)
- Designed specifically for Yamaha V8 outboards
- Large blade and large diameter for maximum thrust
- Excellent acceleration and quick planing



## Saltwater Series XL4

- Shift Dampener System (SDS®)
- Improved acceleration and grip
- Quick planning and reduced ventilation
- Excellent for large V8 powered offshore boats



## TRP

- 60% more blade surface provides transom lifting performance like no other.
- Outstanding handling, greater thrust and unmatched hole shot.
- Requires a TRP (Twin Rotating Propeller Lower Unit)



## Small Hub Series

- Highly-specialized propeller designed for specific applications
- Features an “exhaust-over-the-hub” design, allowing the outboard to develop rpm quicker for faster hole shots.



## XTO OS

- Made to complement the torque potential of the Yamaha V8 XTO Offshore®
- Works in conjunction with the XTO Offshore® lower unit to produce massive thrust in both forward and reverse
- Increased blade surface area is designed for moving large boats and yachts



## XTO EC

- Helps alleviate ventilation that can occasionally occur due to the immense torque potential of Yamaha’s revolutionary 5.6L V8 XTO Offshore® outboard
- XTO EC® propellers use large diameter and specifically-designed blade surface area to push a large column of water
- Designed with extra trailing edge cup to help the blades hold water longer for better grip in applications where ventilation can be an issue



## Turbo Propeller Descriptions



### 2+2 TH

- Excellent sterndrive and V6 four-stroke outboard propeller
- Advanced blade geometry helps maximize performance on deeply submerged drive units
- Improved hole shot, acceleration and ability to effectively power heavier loads than typical three-bladed propellers
- Ideal for water sports or family boating



### 2+2 OT

- Over and thru hub exhaust
- Better acceleration and grip
- Excellent load carrying ability
- Fits a wide variety of V6 outboard applications



### Fusion 4

- Advanced design with aggressive rake, progressive pitch
- Through hub vented exhaust
- Excellent for high horsepower sterndrive and outboard “surfacing” applications in single or multi engine configurations
- Excels on stepped hull offshore boats



### FX4

- Improved bow and stern lift
- Improved acceleration and load carting ability
- Excellent for flats or shallow water boats
- Works well on a broad range of smaller boats and applications



### FXP™

- Designed specifically for ultra-high-performance four-stroke outboards like Yamaha's V MAX SHO®
- Excels in hole shot, acceleration, top speed and handling; all at tournament loads
- Minimal bow rise, steering torque, and operator fatigue
- Excellent for light, high performance bass, bay and flats boats



### Hot Shot

- Ideal for smaller boats and outboards
- Reduced slip and resistance to ventilation
- Increased performance and fuel efficiency
- Increased durability over aluminum

## Lightning

- Aggressive pitch, high rake angle, and large diameter
- Excellent speed, handling, and bow lift
- Thick blades increase strength, longevity, and durability
- Ideal for heavier designed bass and flats boats with high engine mounting heights
- Designed for Yamaha V6, MERCURY®, Johnson®/Evinrude® V6/V8, and Suzuki®



## Offshore I & II

- Excellent for V6 offshore-type applications in single or multiple engine configurations
- Offshore I = 4-blade design/Offshore II = 3-blade design
- Superlative load carrying ability, transom & bow lift for large heavy offshore boats using outboard power
- Outstanding speed and fuel efficiency at cruising RPM's
- Reduced ventilation and slip in rough or following seas



## Pontoon 1

- Use on twin-log pontoon boats and some deck boats, sailboats, and utility/work boats where extra thrust, maneuverability, and control are needed.
- Ideal for many applications using Yamaha's F70 outboard.
- Resists ventilation, particularly in turns and at high engine trim levels



## Quest™

- Very well suited for smaller utility/work boats and Yamaha F70 applications
- Available with 3 or 4 blades



## Turbo 1

- Turbo's most popular and best "all around" performance propeller
- Suitable for most 3 and 4 cylinder outboards and V4/V6 outboards, as well as stern drives and Johnson®/Evinrude® V8 outboards
- Enhanced bow lift, excellent performance, and handling characteristics for medium to heavily loaded boats



# Propellers

General Information

Rigging Estimate Guide (Diagrams)

Rigging Components

Electrical Components

Engine Accessories

**Propellers**

Maintenance Items

Yamalube & Trailer Supplies

Accessories & Apparel



### TXP™

- Excellent high-horsepower, high-speed propeller for very light, high speed boats, particularly those using high engine mounting heights or a hydraulic jack plate and having naturally greater bow lift “built-in”
- Aggressive pitch and cupping
- High rake angle
- Excellent for surface piercing applications



### TXP™ OT4

- Excellent high-horsepower, high-speed propeller for very light, high-speed boats, particularly those using high engine mounting heights or a hydraulic jack plate and having naturally greater bow lift “built-in”
- Faster hole shots and quicker acceleration
- Over and thru hub exhaust helps develop rpm rapidly
- Very aggressive pitch and high rake angle
- Large diameter and advanced trailing edge blade cupping
- Excellent in surface piercing applications



### Ultima 4

- Suitable for V6 outboards utilizing a high engine mounting or operating height, including those with jack plates
- Excellent for bay and flats boats due to stern lift at hole shot and during acceleration
- Excellent performance with improved bow and transom lift
- Resists ventilation and slip in turns and at high engine trim levels



### Vector

- Specifically for sterndrives where the props ride fully submerged
- Also works well on heavier 22'-27' boats, particularly with twin engines
- Faster hole shots and improved planing
- Excellent bow lifting characteristics
- Good performance in rough water

## What does the Yamaha propeller series mean?

The propeller series simply relates to the gearcase diameter. See the chart below for more information.

Propeller Mark	Model	Gear Case Diameter	Spline Count
A	2	1.75"	Shear Pin, no Spline
BS	F2.5	2.00"	9
B	4, 5	2.00"	9
BA	4, 5, F4, F4A, F6A	2.00"	9
N	6, 8, F6, F8	2.25"	7
R	T8, T9.9	2.50"	8
J	9.9 ~ F20	2.50"	8
F	20~30, F25	3.00"	10
G	40~55, T25~F60	3.50"	13
K, KL	60~130, T50~F115	4.25"	15
M, ML	150~200 (4.2L V6)	4.75"	15
T, TL	225~350 (4.2L / 4.3 V6)	4.75"	15
X, XL	F300/F350TR (V8)	5.25"	17
Y	F425, F450	6.00"	18

## How to Pick a Propeller

When it comes to ‘proper propping’, there’s no one particular prop that is perfect for all boat types and applications. This is due primarily to a long list of variables, but there are ways to ‘hone in’ on what you need.

As a general rule, the correct propeller will allow your engine to reach the upper portion of the WOT (wide open throttle) range specified by the manufacturer without exceeding it, with a normal-to-heavy load. For example, if your outboard says WOT (Wide Open Throttle) is 5000-6000 rpm, you need a prop that will allow your engine to turn between approximately 5700 and 6000 rpm with your average load in the boat. Be sure to account for things such as fuel, full bait and/or live wells, batteries, passengers and all gear, including safety gear (anchors, ropes, fire extinguishers, etc.)



### PERFORMANCE BULLETIN

---

**Boat Manufactured By:**  
**JUPITER**  
1103 12th Avenue East • Palmetto, FL 34221  
(941) 729-5000  
www.jupitermarine.com

**JUPITER 26FS**

Length	26' 5"
Beam	8' 8"
Dry Weight (Boat Mfr.)	5,460 lbs
Pods	450 hp
Maximum HP	150 gal
Fuel Capacity	6,324 lbs
Weight as Tested	

**LF200XSA2 / F200XSA2**

Horsepower	200 hp
Induction	EFI/VCT/DOHC
Displacement	2.8L
Weight (Estimated)	525 - 525 lbs
Gear Ratio	1.86:1

**ENGINE MOUNTING HEIGHT**

Mounting Hole Position	#3
------------------------	----

**PROPELLER(S)**

Series	Reliance
Diameter x Pitch	13-3/4" x 19"
Yamaha Part #	68G-45974-20-00 / 68F-45974-20-00
Propeller Material	Stainless Steel

**TEST CONDITIONS**

Number of People	2
Air / Water Temperature (ahrenheit)	71° F / 70° F
Elevation (in feet above sea level)	0'
Wind Velocity	5-10 MPH

**COMMENTS**

Test weight includes 120 gallons of fuel, 3 batteries, safety and test equipment.

YPB#: PB\_JUP\_26FS\_TW\_LF200XSA2\_4-16-24\_OCC



**Engine:** Yamaha LF200XSA2 / F200XSA2  
**Boat:** Jupiter 26FS  
**Configuration:** Twin  
**Test Date:** 16-Apr-2024



**PERFORMANCE DATA**

RPM	MPH	GPH	MPG
1000	5.4	1.8	3.06
1500	7.7	2.9	2.66
2000	9.1	4.9	1.86
2500	10.9	7.7	1.41
3000	18.3	10.3	1.79
<b>3500</b>	<b>27.9</b>	<b>11.9</b>	<b>2.35</b>
4000	34.6	15.9	2.18
4500	39.7	20.8	1.91
5000	44.7	28.1	1.58
5500	50.7	36.4	1.39
<b>6000</b>	<b>53.4</b>	<b>41.2</b>	<b>1.29</b>

0-20 MPH: 6.14 seconds

**NOTICE TO CONSUMER**  
The information and data contained in this Performance Bulletin is approximate and subject to many different factors and variables. It is provided as a guideline only and should not be relied upon as representative of actual performance. Your boat's performance may be different than the information contained in this Performance Bulletin due to various factors, including your boat's actual weight, wind and water conditions, temperature, humidity, elevation, bottom paint, boat options affecting wind/water drag and/or boat weight, and operator ability. Please confirm the specifications and performance data on your specific boat/engine combination with your dealer prior to purchase. Please also keep in mind that the data contained in

**1** | To begin, check Yamaha’s Performance Bulletins at [yamahaoutboards.com/owner-center/performance-bulletins](http://yamahaoutboards.com/owner-center/performance-bulletins). Choose the type of boat most similar to yours (or the one you want), and note what propeller is listed.

**2** | Next, check out the applicable propeller solutions for your outboard on the Yamaha Prop Selector Tool on [yamahaoutboards.com](http://yamahaoutboards.com). Look for the same series name and pitch of propeller as the Performance Bulletin, then adjust the pitch depending on weight and altitude (heavier weight or higher altitude, pitch down; light or low, pitch even or slightly up). Each inch of propeller pitch is equal to approximately 150 +/- 50 rpm.

**3** | Don’t see a Performance Bulletin for your type of boat? Look on the outside barrel for the pitch or remove the prop and look on the inside of the hub for the propeller size, then consult the charts and adjust the pitch accordingly.

**4** | It goes without saying that on-water

testing is always best, as each application is different. That’s where your Yamaha dealer comes in. They’ll be able to help you determine the prop that’s right for you, and may even have the means necessary to test a few. You can find Yamaha Marine dealers on our website. Give them a call to discuss your particular situation. If you can, make sure to have handy any of the above information you’ve recorded, such as:

- Boat make, model and year
- Engine model and Primary Identification Number
- Current prop size and style
- Current maximum rpm at wide open throttle
- Typical and maximum loads (weights) carried



## Propeller Terminology

### Pitch

Pitch is the distance (in inches) a particular prop would theoretically travel in one full revolution, as if traveling through a solid. A lower pitch will have better hole shot and “pushing power” but a lower top speed, while a higher pitch prop will provide less acceleration, but a greater potential for higher top speeds. The correct propeller will allow your engine to reach the upper portion of the WOT range specified by the manufacturer with a normal-to-heavy load (without exceeding it). Each inch of pitch is equal to approximately 150 +/- 50 RPM.

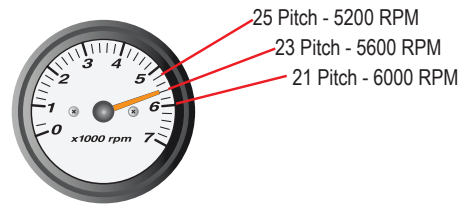

### Diameter

Diameter means the total width of the “circle” at the blade tips as the propeller spins. A larger diameter pushes more water and reaches deeper into the water, so they’re typically used on large, heavy boats or ones with high engine mounting heights. A smaller diameter is usually used on lighter weight boats, where the prop operates lower in the water or when a gain in engine RPM is desired.

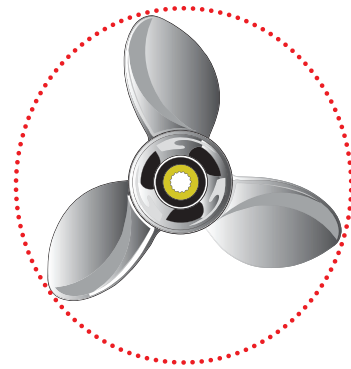

### Number of Blades

Three-bladed propellers are the most common, offering good overall performance, top speed, and efficiency for most applications. Four blades characteristically provide increased acceleration, enhanced bow- and stern-lift, and reduced ventilation. However, four blades typically mean more drag on the engine, resulting in lower top speeds and different handling characteristics.

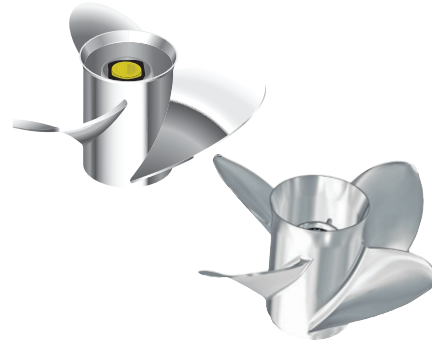

### Blade Surface Area

Blade surface area refers to the total surface of the blades. The more blade surface area a prop has the more water it pushes, for better hole shot and increased planing efficiency. Too much can create significantly more drag, however, potentially restricting engine RPM and causing negative boat-handling issues.

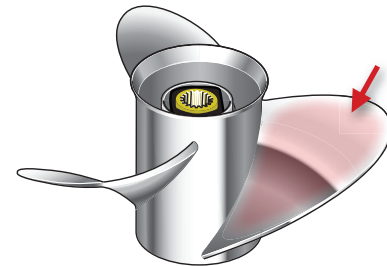

## Propeller Terminology

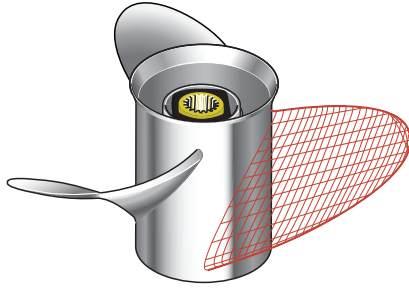

### Blade Geometry

Blade geometry refers to the actual shape of the blade (or ear). By manipulating the blade's shape, diameter and pitch progression, different performance characteristics are created for each different type and style of propeller, pitch is equal to approximately 150 +/- 50 RPM.

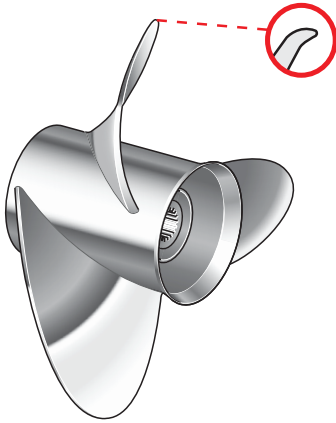

### Cup

Cup is the small curved lip on the blade tip and/or trailing edge. Used in proper amounts, cup helps reduce ventilation and propeller slippage, allowing for higher mounting heights and greater bow lift. Too much cup, however, will cause excessive steering torque and bow lift and limit the engine's ability to develop and maintain proper RPM at a certain pitch.

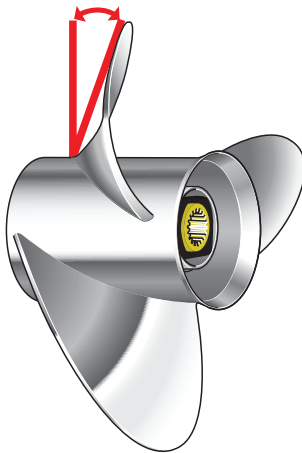

### Rake

Rake is the angle of the blades in relation to the propeller's barrel, or center, and is expressed in degrees. A high rake propeller is best suited for high engine mount applications by helping reduce ventilation and increasing bow lift. Too much rake, however, strains the engine, decreases hole shot and can produce negative performance and handling results. A propeller with a low rake angle will cause less strain on the engine, resulting in potentially better hole shot and higher WOT operating rpm.

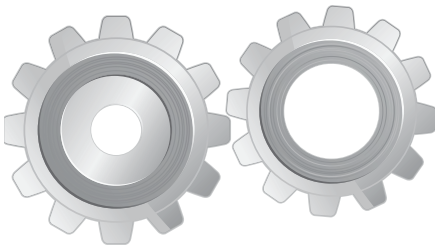

### Gear Ratio

Gear ratio on a marine engine refers to the gears used in the lower unit, much like an automobile's transmission. The higher the ratio, the more pushing power the engine will produce. The lower the ratio, the more top speed the engine can potentially generate. It's important to choose a propeller that allows the engine to operate near the upper end of the manufacturer's recommended wide-open throttle (WOT) RPM under normal loads and conditions.

## Propeller Terminology

### Ventilation

Ventilation is when air is drawn in around the propeller blades. Normally, this causes a gain in rpm, but a loss of speed, since the propeller blades are not biting clean water. This most usually occurs during hard cornering or in certain water conditions, such as following seas.

Controlled ventilation can be beneficial, though, in helping the engine gain rpm during hard acceleration. This is engineered into certain propellers, and is most-usually used on two stroke outboards. An example of this is the small holes in the side of the propeller barrel which allow exhaust to intentionally be drawn in around the blades at hole shot. This helps two stroke engines generate the higher rpm they need for proper hole shot performance. Four stroke engines typically don't need them.

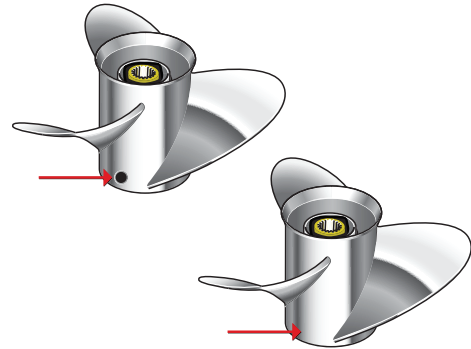

### Cavitation

Cavitation occurs when pressure on the water across the blade's surface is reduced to the point of becoming water vapor, forming bubbles. If these bubbles burst, they can cause a cavitation burn which can deteriorate the propeller's surface and cause negative performance issues. As this condition can cause an increase in engine rpm, it's often confused with ventilation.

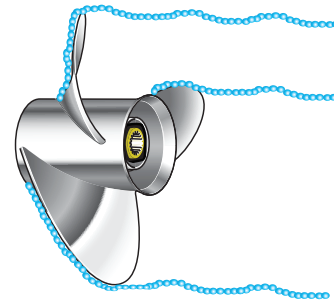

### Slip

Slip is the amount of wasted energy a particular prop generates, meaning that the actual distance traveled in one full propeller revolution is less than its pitch measurement. It is normally expressed as a percentage of inefficiency. A certain amount of slip is engineered into each line of propellers to create different performance characteristics.

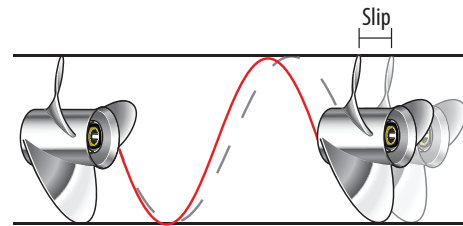

### Hole Shot

"Hole shot" refers to rapid acceleration of the boat, from a standing rest or very slow speed until just on-plane. This is when the engine and the propeller work their hardest.

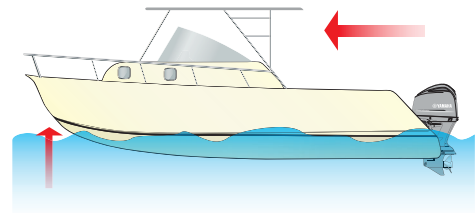

## Propellers for Two Stroke 2-15, and Four Stroke F2.5-F20

Diameter	Pitch	Blades	Rotation	Material	HUB	Part No.
<b>PLASTIC 2HP</b>						
7 1/4	4	3	RH	PS	shear pin	6A1-45943-00-00
<b>ALUMINUM 2HP</b>						
7 1/4	4 1/2	3	RH	AL	shear pin	646-45944-01-00
7 1/4	5 1/2	3	RH	AL	shear pin	646-45942-01-00
<b>ALUMINUM 3   F2.5HP</b>						
7 1/4	5	3	RH	AL	pressed in	6L5-45949-00-00
7 1/4	5 1/2	3	RH	AL	pressed in	6L5-45952-00-00
7 1/4	6	3	RH	AL	pressed in	6L5-45943-00-00
7 1/4	7 1/4	3	RH	AL	pressed in	6L5-45945-00-00
7 1/4	8 1/4	3	RH	AL	pressed in	6L5-45947-00-00
<b>PLASTIC 4   5</b>						
7 1/4	5	3	RH	AL	pressed in	644-45941-01-00
<b>ALUMINUM 4   5   F4   F4A   F6A SINGLE CYL.</b>						
7 1/4	6 1/2	3	RH	AL	pressed in	6E0-45949-00-00
7 1/2	7	3	RH	AL	pressed in	6E0-45943-01-00
7 1/2	7	3	RH	AL	shear pin	6E0-45943-09-00
7 1/4	7 1/4	3	RH	AL	pressed in	6E0-45945-00-00
7 1/2	8	3	RH	AL	pressed in	6E0-45941-01-00
7 1/4	8	3	RH	AL	shear pin	6E0-45941-09-00
7 1/4	8 1/4	3	RH	AL	pressed in	6E0-45952-00-00
7 1/2	9	3	RH	AL	pressed in	6E0-45954-00-00
<b>DUAL THRUST PLASTIC T8   T9.9</b>						
11 3/4	9 1/4	3	RH	PS	pressed in	6G8-45943-00-00
11 3/4	11	3	RH	PS	pressed in	6G8-45941-00-00
11 3/4	12 1/4	3	RH	PS	pressed in	6G8-45945-00-00
<b>DUAL THRUST ALUMINUM T8   T9.9</b>						
11 3/4	5 3/4	3	RH	AL	pressed in	69G-45941-00-00
11 3/4	7	3	RH	AL	pressed in	69G-45943-00-00
11 3/4	9 1/4	3	RH	AL	pressed in	6G8-45947-00-00
<b>ALUMINUM 6   8   F6   F8   F9.9</b>						
9	5	3	RH	AL	pressed in	6G1-W4592-00-00
8 1/2	6 1/2	3	RH	AL	pressed in	6G1-45947-00-00
8 1/2	7 1/2	3	RH	AL	pressed in	6G1-45943-00-00
8 1/2	8	3	RH	AL	pressed in	6G1-45952-00-00
8 1/2	8 1/2	3	RH	AL	pressed in	6G1-45941-00-00
8 1/2	9 1/4	3	RH	AL	pressed in	6G1-45954-00-00
<b>ALUMINUM 9.9   15   F15C   F20</b>						
9 1/2	6 1/2	3	RH	AL	pressed in	683-45949-00-00
9 3/4	6 1/2	3	RH	AL	pressed in	683-W4592-02-00
9 1/4	8	3	RH	AL	pressed in	683-45947-00-00
9 3/4	8	3	RH	AL	pressed in	683-W4591-02-00
9 1/4	9	3	RH	AL	pressed in	63V-45945-10-00
9 1/4	9 3/4	3	RH	AL	pressed in	63V-45952-10-00
9 1/4	10 1/2	3	RH	AL	pressed in	683-45943-00-00

General Information

 Rigging Estimate  
Guide (Diagrams)

Rigging Components

Electrical Components

Engine Accessories

**Propellers**

Maintenance Items

Yamalube &amp; Trailer Supplies

Accessories &amp; Apparel

## Propellers for Two Stroke 2-15, and Four Stroke F2.5-F20 Continued...

Diameter	Pitch	Blades	Rotation	Material	HUB	Part No.
<b>ALUMINUM CUPPED 9.9   15   F15C   F20</b>						
9 1/4	9	3	RH	AL	pressed in	63V-45945-10-00
9 1/4	8	3	RH	AL	pressed in	63V-45947-00-00
9 1/4	10	3	RH	AL	pressed in	63V-45952-10-00
9 1/4	11	3	RH	AL	pressed in	63V-45943-10-00
9 1/4	12	3	RH	AL	pressed in	63V-45941-10-00

## F Series Propellers for 3.0" Gearcases

Yamaha Models F20, 25, C25, F25, T25B and F30

Diameter	Pitch	Blades	Rotation	Material	HUB	Part No.
<b>PERFORMANCE 3</b>						
10 1/8	10	3	RH	SS	pressed in	MAR-GYT3B-02-10
10 1/8	11	3	RH	SS	pressed in	MAR-GYT3B-02-11
10 1/8	12	3	RH	SS	pressed in	MAR-GYT3B-02-12
10 1/8	13	3	RH	SS	pressed in	MAR-GYT3B-02-13
10 1/8	14	3	RH	SS	pressed in	MAR-GYT3B-02-14
<b>ALUMINUM</b>						
9 7/8	8	3	RH	AL	pressed in	664-45943-01-00
9 7/8	9	3	RH	AL	pressed in	664-45941-01-00
9 7/8	10 1/2	3	RH	AL	pressed in	664-45945-00-00
9 7/8	11 1/4	3	RH	AL	pressed in	664-45947-01-00
9 7/8	12	3	RH	AL	pressed in	664-45954-01-00
9 7/8	13	3	RH	AL	pressed in	664-45949-02-00
9 7/8	14	3	RH	AL	pressed in	664-45952-00-00
<b>DUAL THRUST ALUMINUM</b>						
10 5/8	8 1/4	3	RH	AL	pressed in	6J8-W4591-00-00
10 5/8	6 3/4	3	RH	AL	pressed in	6FM-45941-00-00
<b>PAINTED STAINLESS STEEL</b>						
9 1/8	12	3	RH	SS	pressed in	664-45972-00-00
9 1/8	13	3	RH	SS	pressed in	6FM-45941-00-00

## G Series Propellers for 3.5" Gearcases

Yamaha Models T25A, F30, 40, C40, F40, E48, 50, C50, F50, 55, F60

Diameter	Pitch	Blades	Rotation	Material	HUB	Part No.
<b>ALUMINUM</b>						
12 1/4	8	3	RH	AL	pressed in	63D-45941-00-00
12 1/4	9	3	RH	AL	pressed in	663-45956-01-00
11 3/4	10	3	RH	AL	pressed in	663-45954-01-00
11 5/8	11	3	RH	AL	pressed in	69W-45947-00-00
11 3/8	12	3	RH	AL	pressed in	69W-45952-00-00
11 3/8	12	3	RH	AL	pressed in	663-45952-02-00
10 5/8	12	3	RH	AL	pressed in	6H5-45952-00-00
10 3/8	13	3	RH	AL	pressed in	6H5-45945-00-00
11 1/8	13	3	RH	AL	pressed in	69W-45945-00-00

## G Series Propellers for 3.5" Gearcases Continued...

Yamaha Models T25A, F30, 40, C40, F40, E48, 50, C50, F50, 55, F60

Diameter	Pitch	Blades	Rotation	Material	HUB	Part No.
<b>ALUMINUM</b>						
10 1/4	14	3	RH	AL	pressed in	6H5-45958-00-00
11 1/4	14	3	RH	AL	pressed in	663-45958-01-00
11 1/4	14	3	RH	AL	pressed in	69W-45958-00-00
10	15	3	RH	AL	pressed in	6H5-45943-00-00
11	15	3	RH	AL	pressed in	69W-45943-00-00
10 3/4	16	3	RH	AL	pressed in	663-45949-01-00
10 3/4	17	3	RH	AL	pressed in	663-45941-01-00
<b>DUAL THRUST</b>						
12 1/4	9	3	RH	AL	pressed in	68U-45941-00-00
<b>PERFORMANCE 3</b>						
10 1/2	10	3	RH	SS	pressed in	MAR-GYT3B-03-10
10 1/2	11	3	RH	SS	pressed in	MAR-GYT3B-03-11
10 1/2	12	3	RH	SS	pressed in	MAR-GYT3B-03-12
10 1/2	13	3	RH	SS	pressed in	MAR-GYT3B-03-13
10 1/2	14	3	RH	SS	pressed in	MAR-GYT3B-03-14
10 1/2	15	3	RH	SS	pressed in	MAR-GYT3B-03-15
<b>PAINTED STAINLESS</b>						
12	11	3	RH	SS	pressed in	663-45972-60-00
11 3/4	12	3	RH	SS	pressed in	663-45970-60-00
11 1/2	13	3	RH	SS	pressed in	663-45974-60-00
10 5/8	13	3	RH	SS	pressed in	6H5-45952-00-00
10 1/4	14	3	RH	SS	pressed in	663-45930-00-00
11 1/4	14	3	RH	SS	pressed in	697-45970-00-00
10 1/4	15	3	RH	SS	pressed in	663-45976-00-00
10 1/4	16	3	RH	SS	pressed in	663-45978-00-00

## K Series Propellers for 4.25" Gearcases

Yamaha Models T50, C60, E60, P60, T60, 70, F70, P75, C75, E75, F75, F80, 90, C90, F90, VF90, F100,115, C115, F115, VF115, P115,130

Diameter	Pitch	Blades	Rotation	Material	HUB	Part No.
<b>DUAL THRUST</b>						
14	11	3	RH	AL	pressed in	68S-45941-00-00
<b>ALUMINUM</b>						
14	11	3	RH	AL	pressed in	6E5-45954-00-00
13 5/8	13	3	RH	AL	pressed in	6E5-45949-00-00
13 5/8	14	3	RH	AL	pressed in	6E5-45958-00-00
13 1/2	15	3	RH	AL	pressed in	6E5-45947-00-00
13 1/4	17	3	RH	AL	pressed in	6E5-45945-01-00
13	19	3	RH	AL	pressed in	6E5-45941-00-00
12 5/8	21	3	RH	AL	pressed in	6E5-45943-00-00
13	23	3	RH	AL	pressed in	6E5-45952-00-00
13	25	3	RH	AL	pressed in	6E5-45956-00-00

# Propellers

## K Series Propellers for 4.25" Gearcases Continued...

Yamaha Models T50, C60, E60, P60, T60, 70, F70, P75, C75, E75, F75, F80, 90, C90, F90, VF90, F100,115, C115, F115, VF115, P115,130

Diameter	Pitch	Blades	Rotation	Material	HUB	Part No.
<b>TALON</b>						
13 1/2	9	3	RH	AL	SDS*	6EK-45941-00-00
13 1/2	10 1/2	3	RH	AL	SDS*	6EK-45943-00-00
13 1/2	12	3	RH	AL	SDS*	6EK-45945-00-00
13 1/2	14	3	RH	AL	SDS*	6EK-45947-00-00
13 1/2	16	3	RH	AL	SDS*	6EK-45949-00-00
<b>TALON SS</b>						
13 1/8	14	3	RH	SS	SDS*	6N7-45970-00-00
13 1/8	14	3	LH	SS	SDS*	6N4-45970-00-00
13 1/8	16	3	RH	SS	SDS*	6N7-45972-00-00
13 1/8	16	3	LH	SS	SDS*	6N4-45972-00-00
13 1/8	18	3	RH	SS	SDS*	6N7-45974-00-00
13 1/8	18	3	LH	SS	SDS*	6N4-45974-00-00
13 1/8	19	3	RH	SS	SDS*	6N7-45976-00-00
13 1/8	20	3	RH	SS	SDS*	6N7-45978-00-00
13 1/8	20	3	LH	SS	SDS*	6N4-45978-00-00
13 1/8	22	3	RH	SS	SDS*	6N7-45930-00-00
13 1/8	24	3	RH	SS	SDS*	6N7-45932-00-00
<b>TALON GP</b>						
13 5/8	14	3	RH	AL	SDS*	6FP-45941-00-00
13 1/2	15	3	RH	AL	SDS*	6FP-45943-00-00
13 1/4	16	3	RH	AL	SDS*	6FP-45945-00-00
13 1/8	17	3	RH	AL	SDS*	6FP-45947-00-00
13	18	3	RH	AL	SDS*	6FP-45949-00-00
<b>TALON SS4</b>						
13 1/4	14	4	RH	SS	SDS*	6N6-45B70-00-00
13 1/4	16	4	RH	SS	SDS*	6N6-45B72-00-00
13 1/4	18	4	RH	SS	SDS*	6N6-45B74-00-00
13 1/4	20	4	RH	SS	SDS*	6N6-45B76-00-00
13 1/4	22	4	RH	SS	SDS*	6N6-45B78-00-00
13 1/4	23	4	RH	SS	SDS*	6N6-45B80-00-00
<b>TALON PONTOON</b>						
14	9	3	RH	SS	SDS*	6H1-45970-00-00
14	10	3	RH	SS	SDS*	6H1-45972-00-00
14	11	3	RH	SS	SDS*	6H1-45974-00-00
14	12	3	RH	SS	SDS*	6H1-45976-00-00
14	13	3	RH	SS	SDS*	6H1-45978-00-00
<b>PAINTED STAINLESS</b>						
13 1/2	14	3	RH	SS	pressed in	688-45932-60-00
13 1/2	16	3	RH	SS	pressed in	688-45978-60-00
13	17	3	RH	SS	pressed in	688-45930-02-00
13	17	3	LH	SS	pressed in	6L6-45930-01-00

SDS\* = Shift Dampener System

## K Series Propellers for 4.25" Gearcases Continued...

Yamaha Models T50, C60, E60, P60, T60, 70, F70, P75, C75, E75, F75, F80, 90, C90, F90, VF90, F100,115, C115, F115, VF115, P115,130

Diameter	Pitch	Blades	Rotation	Material	HUB	Part No.
<b>PAINTED STAINLESS</b>						
13	19	3	RH	SS	pressed in	688-45970-03-00
13	19	3	LH	SS	pressed in	6L6-45970-00-00
13	21	3	RH	SS	pressed in	688-45972-02-00
13	21	3	LH	SS	pressed in	6L6-45972-00-00
13	23	3	RH	SS	pressed in	688-45974-02-00
13	25	3	RH	SS	pressed in	688-45976-01-00

## P Series Propellers for 4.25" and 4.75" Gearcases for high performance boats 60-200 HP two stroke only

Diameter	Pitch	Blades	Rotation	Material	HUB	Part No.
<b>P SERIES PROPS</b>						
14	20	3	RH	SS	"P" exhaust over hub	6E5-45970-10-00
14	22	3	RH	SS	"P" exhaust over hub	6E5-45976-10-00
14	24	3	RH	SS	"P" exhaust over hub	6E5-45972-10-00
14	26	3	RH	SS	"P" exhaust over hub	6E5-45978-10-00
14	28	3	RH	SS	"P" exhaust over hub	6E5-45974-10-00

## M Series Propellers for 4.75" Gearcases

Yamaha Models 150 - 200, F150 - F200 (V6)

Diameter	Pitch	Blades	Rotation	Material	HUB	Part No.
<b>RELIANCE</b>						
14 1/2	13	3	RH	SS	SDS*	68F-45932-20-00
14 1/2	14	3	RH	SS	SDS*	68F-45930-20-00
14 1/2	14	3	LH	SS	SDS*	68G-45930-20-00
14 1/2	15	3	RH	SS	SDS*	68F-45970-20-00
14 1/2	15	3	LH	SS	SDS*	68G-45970-20-00
14 1/4	17	3	RH	SS	SDS*	68F-45972-20-00
14 1/4	17	3	LH	SS	SDS*	68G-45972-20-00
14 1/4	18	3	RH	SS	SDS*	68F-45978-20-00
14 1/4	18	3	LH	SS	SDS*	68G-45978-20-00
13 3/4	19	3	RH	SS	SDS*	68F-45974-20-00
13 3/4	19	3	LH	SS	SDS*	68G-45974-20-00
13 3/4	21	3	RH	SS	SDS*	68F-45976-20-00
13 3/4	21	3	LH	SS	SDS*	68G-45976-20-00
<b>ALUMINUM</b>						
15 1/4	15	3	RH	AL	pressed in	6G5-45941-00-00
14 5/8	16	3	RH	AL	pressed in	6G5-45952-00-00
14 1/2	17	3	RH	AL	pressed in	6G5-45947-01-00
14 1/2	17	3	LH	AL	pressed in	6K1-45947-00-00
14	19	3	RH	AL	pressed in	6G5-45945-01-00
14	19	3	LH	AL	pressed in	6K1-45945-00-00
13 3/4	21	3	RH	AL	pressed in	6G5-45943-01-00
13 1/2	23	3	RH	AL	pressed in	6G5-45949-00-00

SDS\* = Shift Dampener System



# Propellers

## M Series Propellers for 4.75" Gearcases Continued...

Yamaha Models 150 - 200, F150 - F200 (V6)

Diameter	Pitch	Blades	Rotation	Material	HUB	Part No.
<b>PAINTED STAINLESS STEEL (M SERIES)</b>						
15 3/4	13	3	RH	SS	pressed in	6G5-45932-00-00
15 1/4	15	3	RH	SS	pressed in	6G5-45970-02-00
15 1/4	15	3	LH	SS	pressed in	6K1-45970-01-00
13 3/4	17	3	RH	SS	pressed in	6G5-45978-03-00
13 3/4	17	3	LH	SS	pressed in	6K1-45978-02-00
13 3/4	19	3	RH	SS	pressed in	6G5-45974-03-00
13 3/4	19	3	LH	SS	pressed in	6K1-45974-02-00
13 3/4	21	3	RH	SS	pressed in	6G5-45972-02-00
13 3/4	21	3	LH	SS	pressed in	6K1-45972-01-00
13 3/8	23	3	RH	SS	pressed in	6G5-45976-01-00
13 3/8	23	3	LH	SS	pressed in	6K1-45976-00-00
13 3/8	25	3	LH	SS	pressed in	6G5-45930-00-00
<b>PRO</b>						
14 1/2	21	3	RH	SS	pressed in	66K-45976-B0-00
14 1/2	23	3	RH	SS	pressed in	66K-45974-B0-00
14 1/2	25	3	RH	SS	pressed in	66K-45972-B0-00
14 1/2	27	3	RH	SS	pressed in	66K-45970-B0-00
<b>PERFORMANCE 3</b>						
14 1/4	14	3	RH	SS	SDS*	60H-45970-00-00
14 1/4	14	3	LH	SS	SDS*	60J-45970-00-00
14 1/4	16	3	RH	SS	SDS*	60H-45972-00-00
14 1/4	16	3	LH	SS	SDS*	60J-45972-00-00
14 1/4	18	3	RH	SS	SDS*	60H-45974-00-00
14 1/4	18	3	LH	SS	SDS*	60J-45974-00-00
14 1/4	20	3	RH	SS	SDS*	60H-45976-00-00
14 1/4	20	3	LH	SS	SDS*	60J-45976-00-00
14 1/4	22	3	RH	SS	SDS*	60H-45978-00-00
14 1/4	22	3	LH	SS	SDS*	60J-45978-00-00

## T Series Propellers for 4.75" Gearcases

Yamaha Models 225 - 350, F225 - F350 (V6)

Diameter	Pitch	Blades	Rotation	Material	HUB	Part No.
<b>SALTWATER SERIES II</b>						
15 3/4	13	3	RH	SS	SDS*	6CE-45930-20-00
15 3/4	13	3	LH	SS	SDS*	6CF-45930-20-00
15 3/4	14	3	RH	SS	SDS*	6CE-45D70-20-00
15 3/4	14	3	LH	SS	SDS*	6CF-45D70-20-00
15 3/4	15	3	RH	SS	SDS*	6CE-45976-20-00
15 3/4	15	3	LH	SS	SDS*	6CF-45976-20-00
15 1/2	16	3	RH	SS	SDS*	6CE-45938-20-00
15 1/2	16	3	LH	SS	SDS*	6CF-45938-20-00
15 1/2	17	3	RH	SS	SDS*	6CE-45978-20-00
15 1/2	17	3	LH	SS	SDS*	6CF-45978-20-00
15 1/4	18	3	RH	SS	SDS*	6CE-45934-20-00
15 1/4	18	3	LH	SS	SDS*	6CF-45934-20-00
15 1/4	18	3	LH	SS	SDS*	6CF-45934-20-00

SDS\* = Shift Dampener System

## T Series Propellers for 4.75" Gearcases Continued...

Yamaha Models 225 - 350, F225 - F350 (V6)

Diameter	Pitch	Blades	Rotation	Material	HUB	Part No.
<b>SALTWATER SERIES II</b>						
15 1/4	19	3	RH	SS	SDS*	6CE-45970-20-00
15 1/4	19	3	LH	SS	SDS*	6CF-45970-20-00
15	20	3	RH	SS	SDS*	6CE-45932-20-00
15	20	3	LH	SS	SDS*	6CF-45932-20-00
15	21	3	RH	SS	SDS*	6CE-45972-20-00
15	21	3	LH	SS	SDS*	6CF-45972-20-00
14 3/4	22	3	RH	SS	SDS*	6CE-45936-20-00
14 3/4	22	3	LH	SS	SDS*	6CF-45936-20-00
14 3/4	23	3	RH	SS	SDS*	6CE-45974-20-00
14 3/4	23	3	LH	SS	SDS*	6CF-45974-20-00
14 3/4	24	3	RH	SS	SDS*	6CE-45D72-20-00
14 3/4	24	3	LH	SS	SDS*	6CF-45D72-20-00
14 3/4	25	3	RH	SS	SDS*	6CE-45D74-20-00
14 3/4	25	3	LH	SS	SDS*	6CF-45D74-20-00
<b>SALTWATER SERIES HP</b>						
15 1/4	18	3	RH	SS	SDS*	6KA-45970-00-00
15 1/4	18	3	LH	SS	SDS*	6KB-45970-00-00
15 1/4	19	3	RH	SS	SDS*	6KA-45972-00-00
15 1/4	19	3	LH	SS	SDS*	6KB-45972-00-00
15	20	3	RH	SS	SDS*	6KA-45974-00-00
15	20	3	LH	SS	SDS*	6KB-45974-00-00
15	21	3	RH	SS	SDS*	6KA-45976-00-00
15	21	3	LH	SS	SDS*	6KB-45976-00-00
<b>V MAX SHO</b>						
15 1/8	22	3	RH	SS	pressed in	6CB-45932-11-00
15 1/8	23	3	RH	SS	pressed in	6CB-45974-11-00
15 1/8	24	3	RH	SS	pressed in	6CB-45930-11-00
15 1/8	25	3	RH	SS	pressed in	6CB-45972-11-00
15 1/8	26	3	RH	SS	pressed in	6CB-45978-11-00
15 1/8	27	3	RH	SS	pressed in	6CB-45970-11-00
<b>HS4 "HIGH SEAS"</b>						
15	21	4	RH	SS	SDS*	6CE-45B70-20-00
15	21	4	LH	SS	SDS*	6CF-45B70-20-00
15	22	4	RH	SS	SDS*	6CE-45B72-20-00
15	22	4	LH	SS	SDS*	6CF-45B72-20-00
15	23	4	RH	SS	SDS*	6CE-45B74-20-00
15	23	4	LH	SS	SDS*	6CF-45B74-20-00
<b>PAINTED STAINLESS STEEL (T SERIES)</b>						
15	17	3	RH	SS	pressed in	61A-45978-00-00
15	17	3	LH	SS	pressed in	61B-45978-00-00
14 1/2	19	3	RH	SS	pressed in	61A-45974-00-00
14 1/2	19	3	LH	SS	pressed in	61B-45974-00-00
14 1/2	21	3	RH	SS	pressed in	61A-45972-00-00
14 1/2	21	3	LH	SS	pressed in	61B-45972-00-00

SDS\* = Shift Dampener System

General Information

Rigging Estimate Guide (Diagrams)

Rigging Components

Electrical Components

Engine Accessories

**Propellers**

Maintenance Items

Yamaha & Trailer Supplies

Accessories & Apparel

# Propellers

## T Series Propellers for 4.75" Gearcases Continued...

Yamaha Models 225 - 350, F225 - F350 (V6)

Diameter	Pitch	Blades	Rotation	Material	HUB	Part No.
<b>PERFORMANCE 4</b>						
13 3/4	18	4	RH	SS	pressed in	MAR-GYT4B-V6-18
13 3/4	20	4	RH	SS	pressed in	MAR-GYT4B-V6-20
13 3/4	22	4	RH	SS	pressed in	MAR-GYT4B-V6-22
13 3/4	23	4	RH	SS	pressed in	MAR-GYT4B-V6-23
13 3/4	24	4	RH	SS	pressed in	MAR-GYT4B-V6-24
13 3/4	25	4	RH	SS	pressed in	MAR-GYT4B-V6-25
13 3/4	26	4	RH	SS	pressed in	MAR-GYT4B-V6-26

## X Series Propellers for 5.25" Gearcases

Yamaha V8 Outboard Models

Diameter	Pitch	Blades	Rotation	Material	HUB	Part No.
<b>SALTWATER SERIES XL</b>						
16 1/4	15	3	RH	SS	SDS*	6AW-45970-20-00
16 1/4	15	3	LH	SS	SDS*	6AX-45970-20-00
16 1/4	17	3	RH	SS	SDS*	6AW-45972-20-00
16 1/4	17	3	LH	SS	SDS*	6AX-45972-20-00
15 1/2	19	3	RH	SS	SDS*	6AW-45974-20-00
15 1/2	19	3	LH	SS	SDS*	6AX-45974-20-00
15 1/4	21	3	RH	SS	SDS*	6AW-45976-20-00
15 1/4	21	3	LH	SS	SDS*	6AX-45976-20-00
15 1/4	23	3	RH	SS	SDS*	6AW-45978-20-00
15 1/4	23	3	LH	SS	SDS*	6AX-45978-20-00
<b>SALTWATER SERIES XL4</b>						
16 1/8	15	4	RH	SS	SDS*	6AW-45B70-20-00
16 1/8	15	4	LH	SS	SDS*	6AX-45B70-20-00
16 1/8	17	4	RH	SS	SDS*	6AW-45B72-20-00
16 1/8	17	4	LH	SS	SDS*	6AX-45B72-20-00
15 3/8	22	4	RH	SS	SDS*	6AW-45B76-20-00
15 3/8	22	4	LH	SS	SDS*	6AX-45B76-20-00
15 3/8	24	4	RH	SS	SDS*	6AW-45B74-20-00
15 3/8	24	4	LH	SS	SDS*	6AX-45B74-20-00

SDS\* = Shift Dampener System

## Y Series Propellers for 6.0" Gearcases

Yamaha V8 Outboard Models

Diameter	Pitch	Blades	Rotation	Material	HUB	Part No.
<b>XTO OS®</b>						
17 1/8	15	3	RH	SS	SDS*	6GR-45970-20-00
17 1/8	15	3	LH	SS	SDS*	6GS-45970-20-00
16 7/8	16	3	RH	SS	SDS*	6GR-45D70-20-00
16 7/8	16	3	LH	SS	SDS*	6GS-45D70-10-00
16 7/8	17	3	RH	SS	SDS*	6GR-45972-20-00
16 7/8	17	3	LH	SS	SDS*	6GS-45972-20-00
16 5/8	18	3	RH	SS	SDS*	6GR-45938-20-00
16 5/8	18	3	LH	SS	SDS*	6GS-45938-20-00
16 5/8	19	3	RH	SS	SDS*	6GR-45974-20-00
16 5/8	19	3	LH	SS	SDS*	6GS-45974-20-00
16 3/8	20	3	RH	SS	SDS*	6GR-45936-20-00
16 3/8	20	3	LH	SS	SDS*	6GS-45936-20-00
16 3/8	21	3	RH	SS	SDS*	6GR-45976-20-00
16 3/8	21	3	LH	SS	SDS*	6GS-45976-20-00
16 1/8	22	3	RH	SS	SDS*	6GR-45934-20-00
16 1/8	22	3	LH	SS	SDS*	6GR-45934-20-00
16 1/8	23	3	RH	SS	SDS*	6GR-45978-20-00
16 1/8	23	3	LH	SS	SDS*	6GS-45978-20-00
16	24	3	RH	SS	SDS*	6GR-45932-20-00
16	24	3	LH	SS	SDS*	6GS-45932-20-00
16	25	3	RH	SS	SDS*	6GR-45930-20-00
16	25	3	LH	SS	SDS*	6GS-45930-20-00
16	26	3	RH	SS	SDS*	6GR-45D72-20-00
16	26	3	LH	SS	SDS*	6GS-45D72-20-00
16	27	3	RH	SS	SDS*	6GR45D74-20-00
16	27	3	LH	SS	SDS*	6GS45D74-20-00
<b>XTO EC®</b>						
16 7/8	16	3	RH	SS	SDS	6KN-45938-00-00
16 7/8	16	3	LH	SS	SDS	6KP-45938-00-00
16 7/8	17	3	RH	SS	SDS	6KN-45936-00-00
16 7/8	17	3	LH	SS	SDS	6KP-45970-00-00
16 7/8	18	3	RH	SS	SDS	6KN-45936-00-00
16 7/8	18	3	LH	SS	SDS	6KP-45936-00-00
16 5/8	20	3	RH	SS	SDS	6KN-45976-00-00
16 5/8	20	3	LH	SS	SDS	6KP-45976-00-00
16 3/8	21	3	RH	SS	SDS	6KN-45978-00-00
16 3/8	21	3	LH	SS	SDS	6KP-45978-00-00
16 3/8	22	3	RH	SS	SDS	6KN-45934-00-00
16 3/8	22	3	LH	SS	SDS	6KP-45934-00-00
16 1/8	23	3	RH	SS	SDS	6KN-45932-00-00
16 1/8	23	3	LH	SS	SDS	6KP-45932-00-00
16 1/8	24	3	RH	SS	SDS	6KN-45972-00-00
16 1/8	24	3	LH	SS	SDS	6KP-45972-00-00
16 1/8	25	3	RH	SS	SDS	6KN-45974-00-00
16 1/8	25	3	LH	SS	SDS	6KP-45974-00-00
16 1/8	26	3	RH	SS	SDS	6KN-45930-00-00
16 1/8	26	3	LH	SS	SDS	6KP-45930-00-00

SDS\* = Shift Dampener System

## Small Hub Propellers for High Performance Applications



Diameter	Pitch	Series	Fit	Blades	Part Number
14	20	Small Hub	None	3	6E5-45970-10-00
14	22	Small Hub	None	3	6E5-45976-10-00
14	24	Small Hub	None	3	6E5-45972-10-00
14	26	Small Hub	None	3	6E5-45978-10-00
14	28	Small Hub	None	3	6E5-45974-10-00

## TRP Propellers for TRP Gearcases

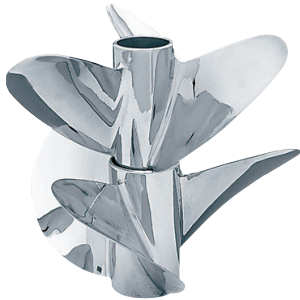

Diameter	Pitch	Series	Fit	Blades	Part Number
14	19	TRP Lower Units	Front	3	MAR-TRP14-19-F3
13	19	TRP Lower Units	Rear	3	MAR-TRP13-19-R3
14	21	TRP Lower Units	Front	3	MAR-TRP14-21-F3
13	21	TRP Lower Units	Rear	3	MAR-TRP13-21-R3



**SHARROW MARINE**  
THE FUTURE OF PROPULSION®

## Sharrows MX3 V6 Propellers

Diameter	Pitch	Blades	Rotation	Material	Hub	Part Number
15.76	13	3	R	SS	pressed in	DBY-MX3V6-13-0R
15.76	13	3	L	SS	pressed in	DBY-MX3V6-13-0L
15.52	16	3	R	SS	pressed in	DBY-MX3V6-16-0R
15.52	16	3	L	SS	pressed in	DBY-MX3V6-16-0L
15.36	17	3	R	SS	pressed in	DBY-MX3V6-17-0R
15.36	17	3	L	SS	pressed in	DBY-MX3V6-17-0L
15.2	18	3	R	SS	pressed in	DBY-MX3V6-18-0R
15.2	18	3	L	SS	pressed in	DBY-MX3V6-18-0L
15.04	19	3	R	SS	pressed in	DBY-MX3V6-19-0R
15.04	19	3	L	SS	pressed in	DBY-MX3V6-19-0L
14.48	20	3	R	SS	pressed in	DBY-MX3V6-20-0R
14.48	20	3	L	SS	pressed in	DBY-MX3V6-20-0L
14.72	21	3	R	SS	pressed in	DBY-MX3V6-21-0R
14.72	21	3	L	SS	pressed in	DBY-MX3V6-21-0L
14.56	22	3	R	SS	pressed in	DBY-MX3V6-22-0R
14.56	22	3	L	SS	pressed in	DBY-MX3V6-22-0L
14.4	23	3	R	SS	pressed in	DBY-MX3V6-23-0R
14.4	23	3	L	SS	pressed in	DBY-MX3V6-23-0L
14.2	24	3	R	SS	pressed in	DBY-MX3V6-24-0R
14.2	24	3	L	SS	pressed in	DBY-MX3V6-24-0L
15.6	15.5	3	R	SS	pressed in	DBY-MX3V6-55-0R
15.6	15.5	3	L	SS	pressed in	DBY-MX3V6-55-0L
15.44	16.5	3	R	SS	pressed in	DBY-MX3V6-65-0R
15.44	16.5	3	L	SS	pressed in	DBY-MX3V6-65-0L
15.28	17.5	3	R	SS	pressed in	DBY-MX3V6-75-0R
15.28	17.5	3	L	SS	pressed in	DBY-MX3V6-75-0L
12.12	18.5	3	R	SS	pressed in	DBY-MX3V6-85-0R
15.12	18.5	3	L	SS	pressed in	DBY-MX3V6-85-0L
14.96	19.5	3	R	SS	pressed in	DBY-MX3V6-95-0R
14.96	19.5	3	L	SS	pressed in	DBY-MX3V6-95-0L
14.8	20.5	3	R	SS	pressed in	DBY-MX3V6-05-0R
14.8	20.5	3	L	SS	pressed in	DBY-MX3V6-05-0L
14.64	21.5	3	R	SS	pressed in	DBY-MX3V6-15-0R
14.64	21.5	3	L	SS	pressed in	DBY-MX3V6-15-0L
14.48	22.5	3	R	SS	pressed in	DBY-MX3V6-25-0R
14.48	22.5	3	L	SS	pressed in	DBY-MX3V6-25-0L
14.2	23.5	3	R	SS	pressed in	DBY-MX3V6-35-0R
14.2	23.5	3	L	SS	pressed in	DBY-MX3V6-35-0L
14.2	24.5	3	R	SS	pressed in	DBY-MX3V6-45-0R
14.2	24.5	3	L	SS	pressed in	DBY-MX3V6-45-0L
14.2	23.5	3	R	SS	pressed in	DBY-MX3V6-35-0R
14.2	23.5	3	L	SS	pressed in	DBY-MX3V6-35-0L
14.2	24.5	3	R	SS	pressed in	DBY-MX3V6-45-0R
14.2	24.5	3	L	SS	pressed in	DBY-MX3V6-45-0L

General Information

Rigging Estimate Guide (Diagrams)

Rigging Components

Electrical Components

Engine Accessories

**Propellers**

Maintenance Items

Yamaha & Trailer Supplies

Accessories & Apparel



## Propellers for 3.0" (F Series) Gearcases

Diameter	Pitch	Blades	Rotation	Material	Hub	Part Number
<b>HOT SHOT FOR JOHNSON®, EVINRUDE®</b>						
10 1/8	10	3	RH	SS	pressed-in	MAR-10110-OR-B0
10 1/8	11	3	RH	SS	pressed-in	MAR-10111-OR-B0
10 1/8	12	3	RH	SS	pressed-in	MAR-10112-OR-B0
10 1/8	13	3	RH	SS	pressed-in	MAR-10113-OR-B0
10 1/8	14	3	RH	SS	pressed-in	MAR-10114-OR-B0
10 1/8	15	3	RH	SS	pressed-in	MAR-10115-OR-B0
<b>HOT SHOT FOR MERCURY®</b>						
10 1/8	10	3	RH	SS	pressed-in	MAR-10110-MR-B0
10 1/8	11	3	RH	SS	pressed-in	MAR-10111-MR-B0
10 1/8	12	3	RH	SS	pressed-in	MAR-10112-MR-B0
10 1/8	13	3	RH	SS	pressed-in	MAR-10113-MR-B0
10 1/8	14	3	RH	SS	pressed-in	MAR-10114-MR-B0
10 1/8	15	3	RH	SS	pressed-in	MAR-10115-MR-B0
<b>HOT SHOT FOR NISSAN®/TOHATSU®</b>						
10 1/8	10	3	RH	SS	pressed-in	MAR-10110-NR-B0
10 1/8	11	3	RH	SS	pressed-in	MAR-10111-NR-B0
10 1/8	12	3	RH	SS	pressed-in	MAR-10112-NR-B0
10 1/8	13	3	RH	SS	pressed-in	MAR-10113-NR-B0
10 1/8	14	3	RH	SS	pressed-in	MAR-10114-NR-B0
10 1/8	15	3	RH	SS	pressed-in	MAR-10115-NR-B0
<b>HOT SHOT FOR SUZUKI®</b>						
10 1/8	10	3	RH	SS	pressed-in	MAR-10110-SR-B0
10 1/8	11	3	RH	SS	pressed-in	MAR-10111-SR-B0
10 1/8	12	3	RH	SS	pressed-in	MAR-10112-SR-B0
10 1/8	13	3	RH	SS	pressed-in	MAR-10113-SR-B0
10 1/8	14	3	RH	SS	pressed-in	MAR-10114-SR-B0
10 1/8	15	3	RH	SS	pressed-in	MAR-10115-SR-B0



## Propellers for 3.5" (G Series) Gearcases

Diameter	Pitch	Blades	Rotation	Material	Hub	Part Number
<b>HOT SHOT</b>						
10 1/2	10	3	RH	SS	See Hub Charts*	MAR-10510-HR-C0
10 1/2	11	3	RH	SS	See Hub Charts*	MAR-10511-HR-C0
10 1/2	12	3	RH	SS	See Hub Charts*	MAR-10512-HR-C0
10 1/2	13	3	RH	SS	See Hub Charts*	MAR-10513-HR-C0
10 1/2	14	3	RH	SS	See Hub Charts*	MAR-10514-HR-C0
10 1/2	15	3	RH	SS	See Hub Charts*	MAR-10515-HR-C0
10 1/2	16	3	RH	SS	See Hub Charts*	MAR-10516-HR-C0
10 1/2	17	3	RH	SS	See Hub Charts*	MAR-10517-HR-C0

\*Most Turbo propellers "G" series (3.5" gearcase diameter) and up require a Guardian SQ-LOK™ hub kit or similar universal hub system. (sold separately) Please see the "Turbo Hub Application Charts" beginning on page 6-35 to determine your required hub.



## Propellers for 3.5" (G Series) Gearcases Continued...

Diameter	Pitch	Blades	Rotation	Material	Hub	Part Number
<b>PONTOON 1</b>						
12	9	3	RH	SS	See Hub Charts*	MAR-12009-PR-C0
12	11	3	RH	SS	See Hub Charts*	MAR-12011-PR-C0
12	12	3	RH	SS	See Hub Charts*	MAR-12012-PR-C0
12	13	3	RH	SS	See Hub Charts*	MAR-12013-PR-C0
12	15	3	RH	SS	See Hub Charts*	MAR-12015-PR-C0



## Propellers for 4.25" (K Series) Gearcases

Diameter	Pitch	Blades	Rotation	Material	Hub	Part Number
<b>TURBO 1</b>						
13 1/4	13	3	RH	SS	See Hub Charts*	MAR-13213-TR-D0
13 1/4	15	3	RH	SS	See Hub Charts*	MAR-13215-TR-D0
13 1/4	17	3	RH	SS	See Hub Charts*	MAR-13217-TR-D0
13 1/4	19	3	RH	SS	See Hub Charts*	MAR-13219-TR-D0
13 1/4	21	3	RH	SS	See Hub Charts*	MAR-13221-TR-D0
13 1/4	23	3	RH	SS	See Hub Charts*	MAR-13223-TR-D0
13 1/4	25	3	RH	SS	See Hub Charts*	MAR-13225-TR-D0
<b>TURBO 1 FOR SUZUKI®</b>						
14	16	3	RH	SS	See Hub Charts*	MAR-14016-SR-E0
14	18	3	RH	SS	See Hub Charts*	MAR-14018-SR-E0
14	20	3	RH	SS	See Hub Charts*	MAR-14020-SR-E0
14	22	3	RH	SS	See Hub Charts*	MAR-14022-SR-E0
<b>PONTOON 1</b>						
14	9	3	RH	SS	See Hub Charts*	MAR-14009-PR-D0
14	11	3	RH	SS	See Hub Charts*	MAR-14011-PR-D0
14	13	3	RH	SS	See Hub Charts*	MAR-14013-PR-D0
14	15	3	RH	SS	See Hub Charts*	MAR-14015-PR-D0
<b>FX4</b>						
13 1/4	14	4	RH	SS	See Hub Charts*	MAR-13414-XR-D0
13 1/4	16	4	RH	SS	See Hub Charts*	MAR-13416-XR-D0
13 1/4	18	4	RH	SS	See Hub Charts*	MAR-13418-XR-D0
13 1/4	20	4	RH	SS	See Hub Charts*	MAR-13420-XR-D0
13 1/4	22	4	RH	SS	See Hub Charts*	MAR-13422-XR-D0
13 1/4	23	4	RH	SS	See Hub Charts*	MAR-13423-XR-D0
13 1/4	24	4	RH	SS	See Hub Charts*	MAR-13424-XR-D0
13 1/4	25	4	RH	SS	See Hub Charts*	MAR-13425-XR-D0

\*Most Turbo propellers "G" series (3.5" gearcase diameter) and up require a Guardian SQ-LOK™ hub kit or similar universal hub system. (sold separately)  
Please see the "Turbo Hub Application Charts" beginning on page 6-35 to determine your required hub.





## Propellers for 4.25" (K Series) Gearcases Continued...

Diameter	Pitch	Blades	Rotation	Material	Hub	Part Number
<b>QUEST™</b>						
13 1/8	14	4	RH	SS	See Hub Charts*	MAR-13414-QR-D0
13 1/8	15	4	RH	SS	See Hub Charts*	MAR-13415-QR-D0
13 1/8	16	4	RH	SS	See Hub Charts*	MAR-13416-QR-D0
13 1/8	17	4	RH	SS	See Hub Charts*	MAR-13417-QR-D0
13 1/8	18	4	RH	SS	See Hub Charts*	MAR-13418-QR-D0
13 1/8	19	4	RH	SS	See Hub Charts*	MAR-13419-QR-D0
13 1/8	20	4	RH	SS	See Hub Charts*	MAR-13420-QR-D0
13 1/8	21	4	RH	SS	See Hub Charts*	MAR-13421-QR-D0



## Propellers for 4.75" (M/T Series) Gearcases

Diameter	Pitch	Blades	Rotation	Material	Hub	Part Number
<b>TURBO 1</b>						
14 1/4	13	3	RH	SS	See Hub Charts*	MAR-14213-TR-E0
14 1/4	15	3	RH	SS	See Hub Charts*	MAR-14215-TR-E0
14 1/4	15	3	LH	SS	See Hub Charts*	MAR-14215-TL-E0
14 1/4	17	3	RH	SS	See Hub Charts*	MAR-14217-TR-E0
14 1/4	17	3	LH	SS	See Hub Charts*	MAR-14217-TL-E0
14 1/4	19	3	RH	SS	See Hub Charts*	MAR-14219-TR-E0
14 1/4	19	3	LH	SS	See Hub Charts*	MAR-14219-TL-E0
14 1/4	20	3	RH	SS	See Hub Charts*	MAR-14220-TR-E0
14 1/4	21	3	RH	SS	See Hub Charts*	MAR-14221-TR-E0
14 1/4	21	3	LH	SS	See Hub Charts*	MAR-14221-TL-E0
14 1/4	22	3	RH	SS	See Hub Charts*	MAR-14222-TR-E0
14 1/4	23	3	RH	SS	See Hub Charts*	MAR-14223-TR-E0
14 1/4	24	3	RH	SS	See Hub Charts*	MAR-14224-TR-E0
14 1/4	25	3	RH	SS	See Hub Charts*	MAR-14225-TR-E0
<b>FXP</b>						
14 3/4	22	3	RH	SS	pressed-in	MAR-14722-R1-00
14 3/4	23	3	RH	SS	pressed-in	MAR-14723-R1-00
14 3/4	24	3	RH	SS	pressed-in	MAR-14724-R1-00
14 3/4	25	3	RH	SS	pressed-in	MAR-14725-R1-00
14 3/4	26	3	RH	SS	pressed-in	MAR-14726-R1-00
14 3/4	27	3	RH	SS	pressed-in	MAR-14727-R1-00

\*Most Turbo propellers "G" series (3.5" gearcase diameter) and up require a Guardian SQ-LOK™ hub kit or similar universal hub system. (sold separately) Please see the "Turbo Hub Application Charts" beginning on page 6-35 to determine your required hub.



## Propellers for 4.75" (M/T Series) Gearcases Continued...

Diameter	Pitch	Blades	Rotation	Material	Hub	Part Number
<b>LIGHTNING</b>						
14 1/2	17	3	RH	SS	See Hub Charts*	MAR-14517-LR-E0
14 1/2	19	3	RH	SS	See Hub Charts*	MAR-14519-LR-E0
14 1/2	21	3	RH	SS	See Hub Charts*	MAR-14521-LR-E0
14 3/4	22	3	RH	SS	See Hub Charts*	MAR-14522-LR-E0
14 3/4	23	3	RH	SS	See Hub Charts*	MAR-14523-LR-E0
14 3/4	24	3	RH	SS	See Hub Charts*	MAR-14524-LR-E0
14 3/4	25	3	RH	SS	See Hub Charts*	MAR-14525-LR-E0
14 3/4	26	3	RH	SS	See Hub Charts*	MAR-14526-LR-E0
14 3/4	27	3	RH	SS	See Hub Charts*	MAR-14527-LR-E0
<b>OFFSHORE II</b>						
15	16	3	RH	SS	See Hub Charts*	MAR-15016-0R-E0
15	16	3	LH	SS	See Hub Charts*	MAR-15016-0L-E0
15	18	3	RH	SS	See Hub Charts*	MAR-15018-0R-E0
15	18	3	LH	SS	See Hub Charts*	MAR-15018-0L-E0
15	20	3	RH	SS	See Hub Charts*	MAR-15020-0R-E0
15	20	3	LH	SS	See Hub Charts*	MAR-15020-0L-E0
15	22	3	RH	SS	See Hub Charts*	MAR-15022-0R-E0
15	22	3	LH	SS	See Hub Charts*	MAR-15022-0L-E0
15	26	3	RH	SS	See Hub Charts*	Discontinued
15	26	3	LH	SS	See Hub Charts*	MAR-15026-0L-E0
<b>VECTOR</b>						
14 1/2	21	3	RH	SS	See Hub Charts*	MAR-14521-VR-E0
14 1/2	21	3	LH	SS	See Hub Charts*	MAR-14521-VL-E0
14 1/2	22	3	RH	SS	See Hub Charts*	MAR-14522-VR-E0
14 1/2	22	3	LH	SS	See Hub Charts*	MAR-14522-VL-E0
14 1/2	23	3	RH	SS	See Hub Charts*	MAR-14523-VR-E0
14 1/2	23	3	LH	SS	See Hub Charts*	MAR-14523-VL-E0
14 1/2	24	3	RH	SS	See Hub Charts*	MAR-14524-VR-E0
14 1/2	24	3	LH	SS	See Hub Charts*	MAR-14524-VL-E0
14 1/2	25	3	RH	SS	See Hub Charts*	MAR-14525-VR-E0
14 1/2	25	3	LH	SS	See Hub Charts*	MAR-14525-VL-E0

\*Most Turbo propellers "G" series (3.5" gearcase diameter) and up require a Guardian SQ-LOK™ hub kit or similar universal hub system. (sold separately) Please see the "Turbo Hub Application Charts" beginning on page 6-35 to determine your required hub.



## Propellers for 4.75" (M/T Series) Gearcases Continued...

Diameter	Pitch	Blades	Rotation	Material	Hub	Part Number
<b>OFFSHORE I</b>						
14 1/2	15	4	RH	SS	See Hub Charts*	MAR-14415-0R-E0
14 1/2	15	4	LH	SS	See Hub Charts*	MAR-14415-0L-E0
14 1/2	17	4	RH	SS	See Hub Charts*	MAR-14417-0R-E0
14 1/2	17	4	LH	SS	See Hub Charts*	MAR-14417-0L-E0
14 1/2	19	4	RH	SS	See Hub Charts*	MAR-14419-0R-E0
14 1/2	19	4	LH	SS	See Hub Charts*	MAR-14419-0L-E0
14 1/2	21	4	RH	SS	See Hub Charts*	MAR-14421-0R-E0
14 1/2	21	4	LH	SS	See Hub Charts*	MAR-14421-0L-E0
14 1/2	23	4	RH	SS	See Hub Charts*	MAR-14423-0R-E0
14 1/2	23	4	LH	SS	See Hub Charts*	MAR-14423-0L-E0
14 1/2	25	4	RH	SS	See Hub Charts*	MAR-14425-0R-E0
14 1/2	25	4	LH	SS	See Hub Charts*	MAR-14425-0L-E0
<b>TXP™</b>						
14 3/4	21	3	RH	SS	See Hub Charts*	MAR-14721-XR-E0
14 3/4	23	3	RH	SS	See Hub Charts*	MAR-14723-XR-E0
14 3/4	24	3	RH	SS	See Hub Charts*	MAR-14724-XR-E0
14 3/4	25	3	RH	SS	See Hub Charts*	MAR-14725-XR-E0
14 3/4	26	3	RH	SS	See Hub Charts*	MAR-14726-XR-E0
14 3/4	27	3	RH	SS	See Hub Charts*	MAR-14727-XR-E0
14 3/4	28	3	RH	SS	See Hub Charts*	MAR-14728-XR-E0
14 3/4	29	3	RH	SS	See Hub Charts*	MAR-14729-XR-E0
14 3/4	30	3	RH	SS	See Hub Charts*	MAR-14730-XR-E0
14 3/4	31	3	RH	SS	See Hub Charts*	MAR-14731-XR-E0
14 3/4	32	3	RH	SS	See Hub Charts*	MAR-14732-XR-E0
<b>TURBO 2+2 OT</b>						
13 3/4	18	4	RH	SS	See Hub Charts*	MAR-13418-TR-E0
13 3/4	20	4	RH	SS	See Hub Charts*	MAR-13420-TR-E0
13 3/4	22	4	RH	SS	See Hub Charts*	MAR-13422-TR-E0
13 3/4	23	4	RH	SS	See Hub Charts*	MAR-13423-TR-E0
13 3/4	24	4	RH	SS	See Hub Charts*	MAR-13424-TR-E0
13 3/4	25	4	RH	SS	See Hub Charts*	MAR-13425-TR-E0
13 3/4	26	4	RH	SS	See Hub Charts*	MAR-13426-TR-E0

\*Most Turbo propellers "G" series (3.5" gearcase diameter) and up require a Guardian SQ-LOK™ hub kit or similar universal hub system. (sold separately) Please see the "Turbo Hub Application Charts" beginning on page 6-35 to determine your required hub.



## Propellers for 4.75" (M/T Series) Gearcases Continued...

Diameter	Pitch	Blades	Rotation	Material	Hub	Part Number
<b>TXP™ (ADJUSTABLE VENTILATION PORTS)</b>						
14 3/4	23	3	RH	SS	See Hub Charts*	MAR-14723-XR-EM
14 3/4	24	3	RH	SS	See Hub Charts*	MAR-14724-XR-EM
14 3/4	25	3	RH	SS	See Hub Charts*	MAR-14725-XR-EM
14 3/4	26	3	RH	SS	See Hub Charts*	MAR-14726-XR-EM
14 3/4	27	3	RH	SS	See Hub Charts*	MAR-14727-XR-EM
14 3/4	28	3	RH	SS	See Hub Charts*	MAR-14728-XR-EM
14 3/4	29	3	RH	SS	See Hub Charts*	MAR-14729-XR-EM
14 3/4	30	3	RH	SS	See Hub Charts*	MAR-14730-XR-EM
14 3/4	31	3	RH	SS	See Hub Charts*	MAR-14731-XR-EM
14 3/4	32	3	RH	SS	See Hub Charts*	MAR-14732-XR-EM
<b>TXP™ OT4</b>						
14 3/8	23	4	RH	SS	See Hub Charts*	MAR-14423-TR-E0
14 3/8	24	4	RH	SS	See Hub Charts*	MAR-14424-TR-E0
14 3/8	25	4	RH	SS	See Hub Charts*	MAR-14425-TR-E0
14 3/8	26	4	RH	SS	See Hub Charts*	MAR-14426-TR-E0
14 3/8	27	4	RH	SS	See Hub Charts*	MAR-14427-TR-E0
14 3/8	28	4	RH	SS	See Hub Charts*	MAR-14428-TR-E0
14 3/8	29	4	RH	SS	See Hub Charts*	MAR-14429-TR-E0
14 3/8	30	4	RH	SS	See Hub Charts*	MAR-14430-TR-E0
14 3/8	31	4	RH	SS	See Hub Charts*	MAR-14431-TR-E0
<b>TXP™ OT4 (ADJUSTABLE VENTILATION PORTS)</b>						
14 3/8	24	4	RH	SS	See Hub Charts*	MAR-14424-TR-EM
14 3/8	25	4	RH	SS	See Hub Charts*	MAR-14425-TR-EM
14 3/8	26	4	RH	SS	See Hub Charts*	MAR-14426-TR-EM
14 3/8	27	4	RH	SS	See Hub Charts*	MAR-14427-TR-EM
14 3/8	28	4	RH	SS	See Hub Charts*	MAR-14428-TR-EM
14 3/8	29	4	RH	SS	See Hub Charts*	MAR-14429-TR-EM
14 3/8	30	4	RH	SS	See Hub Charts*	MAR-14430-TR-EM
14 3/8	31	4	RH	SS	See Hub Charts*	MAR-14431-TR-EM
<b>2+2TH</b>						
14	16	4	RH	SS	See Hub Charts*	MAR-14416-HR-E0
14	18	4	RH	SS	See Hub Charts*	MAR-14418-HR-E0
14	20	4	RH	SS	See Hub Charts*	MAR-14420-HR-E0
14	22	4	RH	SS	See Hub Charts*	MAR-14422-HR-E0
14	24	4	RH	SS	See Hub Charts*	MAR-14424-HR-E0
14	25	4	RH	SS	See Hub Charts*	MAR-14425-HR-E0
14	26	4	RH	SS	See Hub Charts*	Discontinued

\*Most Turbo propellers "G" series (3.5" gearcase diameter) and up require a Guardian SQ-LOK™ hub kit or similar universal hub system. (sold separately) Please see the "Turbo Hub Application Charts" beginning on page 6-35 to determine your required hub.



## Propellers for 4.75" (M/T Series) Gearcases Continued...

Diameter	Pitch	Blades	Rotation	Material	Hub	Part Number
<b>FUSION 4</b>						
14 1/2	21	4	RH	SS	See Hub Charts*	MAR-14421-FR-E0
14 1/2	21	4	LH	SS	See Hub Charts*	MAR-14421-FL-E0
14 1/2	22	4	RH	SS	See Hub Charts*	MAR-14422-FR-E0
14 1/2	22	4	LH	SS	See Hub Charts*	MAR-14422-FL-E0
14 1/2	23	4	RH	SS	See Hub Charts*	MAR-14423-FR-E0
14 1/2	23	4	LH	SS	See Hub Charts*	MAR-14423-FL-E0
14 1/2	24	4	RH	SS	See Hub Charts*	MAR-14424-FR-E0
14 1/2	24	4	LH	SS	See Hub Charts*	MAR-14424-FL-E0
14 1/2	25	4	RH	SS	See Hub Charts*	MAR-14425-FR-E0
14 1/2	26	4	RH	SS	See Hub Charts*	MAR-14426-FR-E0
<b>ULTIMA 4</b>						
14 1/4	13	4	RH	SS	See Hub Charts*	MAR-14413-UR-E0
14 1/4	13	4	LH	SS	See Hub Charts*	MAR-14413-UL-E0
14 1/4	15	4	RH	SS	See Hub Charts*	MAR-14415-UR-E0
14 1/4	15	4	LH	SS	See Hub Charts*	MAR-14415-UL-E0
14 1/4	17	4	RH	SS	See Hub Charts*	MAR-14417-UR-E0
14 1/4	17	4	LH	SS	See Hub Charts*	MAR-14417-UL-E0
14 1/4	19	4	RH	SS	See Hub Charts*	MAR-14419-UR-E0
14 1/4	19	4	LH	SS	See Hub Charts*	MAR-14419-UL-E0
14 1/4	21	4	RH	SS	See Hub Charts*	MAR-14421-UR-E0
14 1/4	21	4	LH	SS	See Hub Charts*	MAR-14421-UL-E0
14 1/4	23	4	RH	SS	See Hub Charts*	MAR-14423-UR-E0
14 1/4	23	4	LH	SS	See Hub Charts*	MAR-14423-UL-E0

\*Most Turbo propellers "G" series (3.5" gearcase diameter) and up require a Guardian SQ-LOK™ hub kit or similar universal hub system. (sold separately)  
Please see the "Turbo Hub Application Charts" beginning on page 6-35 to determine your required hub.

## Hubs for Yamaha Propellers

Hub Application	Engine Horsepower	Part Number
TRP Front Propellers	TRP Lower Units	65N-45981-00-00
TRP Rear Propellers	TRP Lower Units	6G5-45981-00-00
K Series Propellers	(T50~F115, 70~115)	688-45981-00-00
G Series Propellers	(T25~F60, 50)	663-45981-10-00
ALUMINUM 6E5, 688, 6L6, 6G5, 6K1 Propellers	150hp~300hp	6G5-45981-00-00
6D0, 6D1, 68F, 68G Propellers	150hp~300hp	61A-45981-00-00
66K, 6R1, 6R4, 61A, 61B, 69L, 6G5, 6K1 Propellers	150hp~300hp	61A-45981-00-00
Small Hub Propellers	70hp~200hp	6G5-45981-00-00
6J8 and 664 Propellers	F25, 20~30	664-45981-01-00
N Series Propellers	6,8	6G1-45981-00-00
683 Propellers J Series	9.9, 15, F9.9, T9.9	683-45981-10-00
F350/F350A SDS Propellers	V8	6AW-45C80-00-00
F350B/F350C SDS Propellers	V8	6AW-45C81-10-00
F350 Non-SDS Propellers	V8	6AW-45981-00-00
F425A/F425B SDS Propellers	V8	6GR-45C81-10-00
F450 SDS Propellers	V8	6GR-45C81-10-00
Reliance / Saltwater Series SDS Propellers	F150~F350 (V6)	6CE-45C81-10-00
Talon Brass Hub	Talon Propellers	6EK-45982-00-00
Talon Rubber Dampers (3 pack)	Talon Propellers	6EK-45C82-09-00

\*See OSM2014-001 for acceptable greases



## Hubs for Turbo Propellers

### Guardian SQ-Lok™ Hub System

A square hub is required for proper installation of Turbo® propellers. Turbo proudly recommends the Guardian SQ-Lok™ Hub System. Guardian SQ-Lok™ hubs are designed to take the punishing power and exhaust heat today's modern marine engines deliver. Unlike some other brands, they feature heavy-duty construction and a nylon center core (drive adaptor) with a molded-in interlocking brass spline insert for extra strength and durability. They're easy to install or replace, and come with the necessary hardware to help get you on the water fast. Demand tough. Demand convenient. Demand a Guardian SQ-Lok™ hub system.



MAR-C014H-UB-00



MAR-C011H-UB-00



MAR-C012H-UB-00



MAR-C013H-UB-00



MAR-D500H-UB-00



MAR-D501H-UB-00



MAR-D506H-UB-00

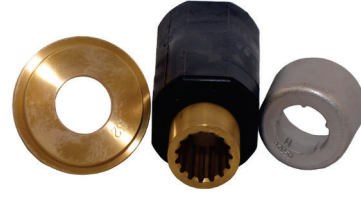

MAR-D502H-UB-00



MAR-D503H-UB-00



MAR-D504H-UB-00



MAR-D505H-UB-00

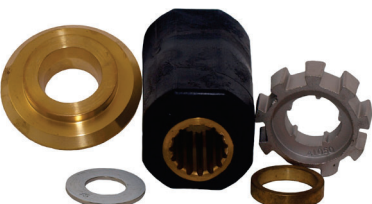

MAR-D507H-UB-00

## Turbo Hub Application Charts

All Turbo propellers “G” series (3.5” gearcase diameter and up) require a Guardian SQ-LOK™ hub kit or similar universal hub system. Use the charts below to find the required hub for your application.

Sterndrive Hub Applications					
Make / Model	Model Notes	Year(s)	Gearcase Diameter	Splines	Hub Part Number
Mercruiser®	1A, 1B, 1C		4.75"	15	MAR-D501H-UB-00
Mercruiser®	120, 140, 145 DTS		4.75"	15	MAR-D501H-UB-00
Mercruiser®	165, 228, 470, 485, 888, 898		4.75"	15	MAR-D501H-UB-00
Mercruiser®	225S, 233, 255TRS		4.75"	15	MAR-D501H-UB-00
Mercruiser®	260, 280TRS, 330TRS		4.75"	15	MAR-D501H-UB-00
Mercruiser®	120-190 HP	1983-1985	4.75"	15	MAR-D501H-UB-00
Mercruiser®	200-260 HP	1983-1985	4.75"	15	MAR-D501H-UB-00
Alpha One®	2.5L - 5.7L	All Years	4.75"	15	MAR-D501H-UB-00
Alpha One®	6.2L MPI	All Years	4.75"	15	MAR-D501H-UB-00
Alpha One®	262, 350, 354 Magnum	All Years	4.75"	15	MAR-D501H-UB-00
Alpha One®	320 EFI	All Years	4.75"	15	MAR-D501H-UB-00
Alpha One®	D2.8L - D7.3L (Diesel)	All Years	4.75"	15	MAR-D501H-UB-00
Bravo One®	320 EFI, 350, 377	All Years	4.75"	15	MAR-D501H-UB-00
Bravo One®	5.0L - 7.4L	All Years	4.75"	15	MAR-D501H-UB-00
OMC™	3.0 L - 8.2 L (Non SX Drive)	1990-1993	4.75"	15	MAR-D502H-UB-00
OMC™ Cobra™	5.8 L	1989-1993	4.75"	15	MAR-D502H-UB-00
Sea Drive™	2.0 L - 4.0 L	All Years	4.75"	15	MAR-D502H-UB-00
OMC™ Model 400	2.3 L (120 HP)	~1991	4.25"	13	MAR-D503H-UB-00
OMC™ Model 400	2.5 L (120 HP)	1978-1984	4.25"	13	MAR-D503H-UB-00
OMC™ Model 400	3.0 L (140 HP)	Thru 1989	4.25"	13	MAR-D503H-UB-00
OMC™ Cobra™	2.3 L (128 HP)	1988-1991	4.25"	13	MAR-D503H-UB-00
OMC™ Cobra™	2.5 L (120 HP)	1985-1987	4.25"	13	MAR-D503H-UB-00
OMC™ Cobra™	3.0 L (140 HP)	1985-1987	4.25"	13	MAR-D503H-UB-00
OMC™ Sea Drive™	1.6 L V-4	1982~	4.25"	13	MAR-D503H-UB-00
OMC™ Sea Drive™	1.8 L V-4	1987~	4.25"	13	MAR-D503H-UB-00
SX COBRA™, VOLVO PENTA® SX	3.0 L	1994 & Newer	4.75"	19	MAR-D504H-UB-00
SX COBRA™, VOLVO PENTA® SX	4.3 L	1994 & Newer	4.75"	19	MAR-D504H-UB-00
SX COBRA™, VOLVO PENTA® SX	5.0 L	1994 & Newer	4.75"	19	MAR-D504H-UB-00
SX COBRA™, VOLVO PENTA® SX	5.7 L	1994 & Newer	4.75"	19	MAR-D504H-UB-00
SX COBRA™, VOLVO PENTA® SX	5.8 L	1994-1997	4.75"	19	MAR-D504H-UB-00
SX COBRA™, VOLVO PENTA® SX	7.4 L	1997 & Newer	4.75"	19	MAR-D504H-UB-00
SX COBRA™, VOLVO PENTA® SX	8.2 L	1997	4.75"	19	MAR-D504H-UB-00
YAMAHA STERNDRIVES	3.0 L (130 HP) EST/PSR	1989-1993	4.75"	15	MAR-D505H-UB-00
YAMAHA STERNDRIVES	4.3 L (205 HP) EST/PSR/YEMS	1989-1993	4.75"	15	MAR-D505H-UB-00
YAMAHA STERNDRIVES	5.0 L (205 HP) EST/PSR/YEMS	1989-1993	4.75"	15	MAR-D505H-UB-00
YAMAHA STERNDRIVES	5.7 L (260 HP) EST/PSR/YEMS	1989-1993	4.75"	15	MAR-D505H-UB-00
YAMAHA STERNDRIVES	7.4 L (300 HP) EST	1992-1993	4.75"	15	MAR-D505H-UB-00

General Information

Rigging Estimate Guide (Diagrams)

Rigging Components

Electrical Components

Engine Accessories

**Propellers**

Maintenance Items

Yamalube & Trailer Supplies

Accessories & Apparel



# Propellers

## MERCURY® 2-Stroke Hub Applications

Horsepower	Model Notes	Years	Gearcase Diameter	Splines	RPM Range	Gear Ratio	Hub Part Number
30 HP	(SeaPro®/Marathon)	1994~	3.25	13	4500-5500	2.00	MAR-C011H-UB-00
30 HP	2-Stroke	1994-2002	3.25	13	4500-5500	2.00	MAR-C011H-UB-00
35 HP		1984-1989	3.25	13	4500-5500	2.00	MAR-C011H-UB-00
40 HP	(Model 402)	1974-1976	3.25	13	4500-5500	2.00	MAR-C011H-UB-00
40 HP	(SeaPro®/Marathon)	1977~	3.25	13	4500-5500	2.00	MAR-C011H-UB-00
40 HP	2-Stroke (Includes Model 402)	1977~	3.25	13	5000-5500	1.83	MAR-C011H-UB-00
45 HP		1986-1989	3.25	13	5000-5500	1.83	MAR-C011H-UB-00
48 HP	(Mariner®)	All Years	3.25	13	5000-5500	1.83	MAR-C011H-UB-00
50 HP	(Model 500)	1974-1976	3.25	13	5000-5500	1.83	MAR-C011H-UB-00
50 HP	2-Stroke (Includes Model 500)	1977~	3.25	13	5000-5500	1.83	MAR-C011H-UB-00
55 HP	(MERCURY®/SeaPro®/Marathon)	1995~	3.25	13	5000-5500	1.83	MAR-C011H-UB-00
60 HP	2-Stroke	1978~	3.25	13	5000-5500	1.64	MAR-C011H-UB-00
60 HP	(SeaPro®/Marathon)	1995~	4.25	15	4500-5500	2.30	MAR-D501H-UB-00
65 HP	(Model 650 - 4 Cyl.)	1961-1970	4.25	15	4500-5500	2.30	MAR-D501H-UB-00
65 HP	(Model 650 - 2 Cyl.)	~1971	4.25	15	4500-5500	2.30	MAR-D501H-UB-00
70 HP		1987-1989	4.25	15	4500-5500	2.30	MAR-D501H-UB-00
70 HP	(Includes Model 700)	~1983	3.25	13	4500-5500	2.30	MAR-C011H-UB-00
75 HP	(SeaPro®/Marathon)	All Years	4.25	15	4750-5250	2.30	MAR-D501H-UB-00
75 HP	Optimax®		4.25	15	5000-5750	2.33	MAR-D501H-UB-00
80 HP	(Mariner®)	1978-1983	4.25	15			MAR-D501H-UB-00
80 HP		1978-1989	4.25	15			MAR-D501H-UB-00
90 HP	2-Stroke	1989-2004	4.25	15	5000-5500	2.30	MAR-D501H-UB-00
90 HP	Optimax®	2005~	4.25	15	5000-5500	2.33	MAR-D501H-UB-00
100 HP		1988~	4.25	15	4750-5250	2.07	MAR-D501H-UB-00
	Models 900 1150 1500	~1977	4.25	15	4750-5250	2.07	MAR-D501H-UB-00
115 HP		1978-1983	4.25	15	4750-5250	2.07	MAR-D501H-UB-00
115 HP	Optimax®	2007~	4.25	15	5000-5700	2.07	MAR-D501H-UB-00
125 HP		1994-2005	4.25	15	4750-5250	2.07	MAR-D501H-UB-00
135 HP		1987~	4.75	15	5000-5600	2.00	MAR-D501H-UB-00
135 HP	Optimax®	1996~	4.75	15	5250-5750	2.00	MAR-D501H-UB-00
140 HP		All Years	4.25	15			MAR-D501H-UB-00
150 HP		1978~	4.75	15	5000-5600	1.87	MAR-D501H-UB-00
150 HP	Optimax®	2004~	4.75	15	5250-5750	1.87	MAR-D501H-UB-00
175 HP		1978~	4.75	15	5000-5600	1.87	MAR-D501H-UB-00
175 HP	Optimax®	2000~	4.75	15	5250-5750	1.87	MAR-D501H-UB-00
200 HP		1978~	4.75	15	5000-5600	1.87	MAR-D501H-UB-00
200 HP	Optimax®	1998~	4.75	15	5000-5750	1.87	MAR-D501H-UB-00
220 HP		1987-1988	4.75	15	5000-5600	1.87	MAR-D501H-UB-00
225 HP		1980~	4.75	15	5000-5750	1.75	MAR-D501H-UB-00
225 HP	Optimax®	1998~	4.75		5000-5750	1.75	MAR-D501H-UB-00
3.4 Liter		1984-1986	4.75	15	5000-5750	1.75	MAR-D501H-UB-00
250 HP	Optimax®	2007~	4.75		5000-5750	1.75	MAR-D501H-UB-00
275 HP		1990-1994	4.75	15	5000-5750	1.75	MAR-D501H-UB-00
300 HP		1983; 1999~	4.75	15	5000-5750	1.75	MAR-D501H-UB-00

## MERCURY® 4-Stroke Hub Applications

Horsepower	Model Notes	Years	Gearcase Diameter	Splines	RPM Range	Gear Ratio	Hub Part Number
25 HP	4-Stroke/Bigfoot	1999-2005	3.5"	13	5250-5750	2.40	MAR-C011H-UB-00
30 HP	4-Stroke	1999-2005	3.5"	13	5500-6000	2.00	MAR-C011H-UB-00
40 HP	4-Stroke (Not Bigfoot)	1997~	3.5"	13	5500-6000	2.00	MAR-C011H-UB-00
40 HP	4-Stroke / Bigfoot	All Years	3.5"	15			MAR-D501H-UB-00
50 HP	4-Stroke (Not Bigfoot)	1995~	3.5"	13	5500-6000	1.83	MAR-C011H-UB-00
50 HP	4-Stroke / Bigfoot	All Years	4.25"	15	5500-6000	2.33	MAR-D501H-UB-00
60 HP	4-Stroke (Not Bigfoot)	2001~	3.25"	13	5500-6000	1.83	MAR-C011H-UB-00
60 HP	4-Stroke / Bigfoot	1995~	4.25"	15	5500-6000	2.33	MAR-D501H-UB-00
75 HP	4-Stroke	2001~	4.25"	15	4500-5500	2.33	MAR-D501H-UB-00
90 HP	4-Stroke	2001~	4.25"	15	5000-6000	2.33	MAR-D501H-UB-00
115 HP	4-Stroke	2001-2006	4.25"	15	5000-6000	2.07	MAR-D501H-UB-00
115 HP	EFI 4-Stroke	2007~	4.25"	15	5800-6400	2.07	MAR-D501H-UB-00
135 HP	Verado®	2007~	4.75"	15	5200-6400	2.08	MAR-D501H-UB-00
150 HP	Verado®	2006~	4.75"	15	5800-6400	2.08	MAR-D501H-UB-00
175 HP	Verado®	2006~	4.75"	15	5800-6400	2.08	MAR-D501H-UB-00
200 HP	Verado®	2005~	4.75"	15	5800-6400	2.08	MAR-D501H-UB-00
225 HP	Verado®	2005~	4.75"	15	5800-6400	1.85	MAR-D501H-UB-00
250 HP	Verado®	2005~	4.75"	15	5800-6400	1.85	MAR-D501H-UB-00
275 HP	Verado®	2005~	4.75"	15	5800-6400	1.85	MAR-D501H-UB-00

## Honda® Hub Applications

Horsepower	Model Notes	Years	Gearcase Diameter	Splines	RPM Range	Gear Ratio	Hub Part Number
35 HP	BF 35	1991-1994	3.5"	13	4600-5600	2.09	MAR-C012H-UB-00
40 HP	BF 40	1995~	3.5"	13	5000-6000	2.09	MAR-C012H-UB-00
45 HP	BF 45	1991-1994	3.5"	13	5000-6000	2.09	MAR-C012H-UB-00
50 HP	BF50/50A	1995~	3.5"	13	5500-6000	2.09	MAR-C012H-UB-00
60 HP	BF 60	2010~	3.5"	13	5000-6000	2.07	MAR-C012H-UB-00
60 HP	BFP 60	2010~	4.25"	15	5000-6000	2.33	MAR-D507H-UB-00
75 HP	BF 75	1995~	4.25"	15	5000-6000	2.33	MAR-D507H-UB-00^^
90 HP	BF 90	1995-2002	4.25"	15	5000-6000	2.33	MAR-D507H-UB-00^^
90 HP	BF 90	2003-2006	4.25"	15	5000-6000	2.30	MAR-D507H-UB-00
90 HP	BF 90	2007~	4.25"	15	5300-6300	2.33	MAR-D507H-UB-00
115 HP	BF 115	1998~	4.25"	15	5000-6000	2.00	MAR-D507H-UB-00
130 HP	BF 130	1998-2004	4.25"	15	5000-6000	2.00	MAR-D507H-UB-00
135 HP	BF 135	2004~	4.25"	15	5000-6000	2.14	MAR-D507H-UB-00
150 HP	BF 150	2004~	4.25"	15	5000-6000	2.14	MAR-D507H-UB-00
200 HP	BF 200	2002~	4.25"	15	5000-6000	1.86	MAR-D507H-UB-00
225 HP	BF 225	2002~	4.25"	15	5000-6000	1.86	MAR-D507H-UB-00

^^ BF75,BF90 (~1998) Use MAR-D501H-UB-00

# Propellers

## Evinrude® / Johnson® 2-Stroke Hub Applications

Horsepower	Model Notes	Years	Gearcase Diameter	Splines	RPM Range	Gear Ratio	Hub Part Number
40 HP	E-Tec®	2004~	4.25"	13	5500-6000	2.67	MAR-D503H-UB-00
40 HP	2 Cyl	1984-2005	3.38"	13	4500-5500	2.42	MAR-C012H-UB-00
45 HP	2 Cyl. Commercial	1986-1995	4.25"	13			MAR-D503H-UB-00
48 HP		1987~	3.38"	13			MAR-C012H-UB-00
50 HP	2 Cyl	1975-2005	3.38"	13	4500-5500	2.42	MAR-C012H-UB-00
50 HP	2 Cyl. Commercial	1977-1979	4.25"	13			MAR-D503H-UB-00
50 HP	2 Cyl. Pleasure	1971-1974	4.25"	13			MAR-D503H-UB-00
50 HP	3 Cyl. Pleasure	1994-1998	4.25"	13			MAR-D503H-UB-00
50 HP	E-Tec®	2004~	4.25"	13	5500-6000	2.67	MAR-D503H-UB-00
55 HP		1976-1979	3.38"	13			MAR-C012H-UB-00
55 HP	3 Cyl	1968-1969	4.25"	13			MAR-D503H-UB-00
55 HP	2 Cyl. Commercial	1980~	4.25"	13			MAR-D503H-UB-00
55 HP	E-Tec®	2009~	4.25"	13	5500-6000	2.67	MAR-D503H-UB-00
Sprint/Formula E		1986-1992	3.38"	13			MAR-C012H-UB-00
60 HP	3 Cyl. Pleasure	1970-1971	4.25"	13			MAR-D503H-UB-00
60 HP	3 Cyl	1986-2001	4.25"	13			MAR-D503H-UB-00
60 HP	E-Tec®	2004~	4.25"	13	5500-6000	2.67	MAR-D503H-UB-00
65 HP	2 Cyl	1980-1985	3.38"	13			MAR-C012H-UB-00
65 HP	3 Cyl. Pleasure	1972-1973	4.25"	13			MAR-D503H-UB-00
65 HP	3 Cyl. Commercial	1984-2001	4.25"	13			MAR-D503H-UB-00
70 HP	3 Cyl. Commercial	1974-2001	4.25"	13			MAR-D503H-UB-00
75 HP	E-Tec®	2004~	4.25"	13	4500-5500	2.00	MAR-D503H-UB-00
75 HP	3 Cyl	1975-1985	3.38"	13			MAR-C012H-UB-00
75 HP	3 Cyl. Pleasure	1975-1984	4.25"	13			MAR-D503H-UB-00
85 HP	V4	1969-1980	4.25"	13			MAR-D503H-UB-00
85 HP	V4	1991-1995	4.25"	13			MAR-D503H-UB-00
88 HP	V4	1981-1996	4.25"	13			MAR-D503H-UB-00
90 HP	V4	1981~	4.25"	13			MAR-D503H-UB-00
90 HP	V6	1995~	4.75"	15			MAR-D502H-UB-00
90 HP	E-Tec® Std. Length	2004~	4.25"	13	4500-5500	2.00 / 2.25	MAR-D503H-UB-00
100 HP	V4	1979-1980	4.25"	13			MAR-D503H-UB-00
100 HP	V4	1989-1993	4.25"	13			MAR-D503H-UB-00
100 HP	V6 Commercial	1984~	4.75"	15			MAR-D502H-UB-00
110 HP	V4	1986-1989	4.25"	13			MAR-D503H-UB-00
112 HP	V4	1994-1996	4.25"	13			MAR-D503H-UB-00
115 HP	E-Tec® (Includes H.O.)	2004~	4.25"	13	4500-5500	2.00 / 2.25	MAR-D503H-UB-00
115 HP	V6	1995~	4.75"	15			MAR-D502H-UB-00
115 HP	V4	1973~	4.25"	13			MAR-D503H-UB-00
120 HP	V4	1986-1994	4.25"	13			MAR-D503H-UB-00
120 HP	V6	1985	4.75"	15			MAR-D502H-UB-00
125 HP	V4	1971-1972	4.25"	13			MAR-D503H-UB-00
130 HP	V6	1995~	4.75"	15			MAR-D502H-UB-00
130 HP	E-Tec®	2004~	4.25"	13	5500-6000	2.00 / 2.25	MAR-D503H-UB-00
135 HP	V4	1973-1976	4.25"	13			MAR-D503H-UB-00
140 HP	V4	1977-1994	4.25"	13			MAR-D503H-UB-00

## Evinrude® / Johnson® 2-Stroke Hub Applications Continued...

Horsepower	Model Notes	Years	Gearcase Diameter	Splines	RPM Range	Gear Ratio	Hub Part Number
140 HP	V6	1985	4.75"	15			MAR-D502H-UB-00
140 HP	V6 (25")	1989-1994	4.75"	15			MAR-D502H-UB-00
150 Hp	E-Tec®	2009~	4.75"	15	4850-5850	1.86	MAR-D502H-UB-00
150 HP	V6	1978~	4.75"	15	4500-5500	1.86	MAR-D502H-UB-00
150 HP	V6 Commercial	1995~	4.75"	15			MAR-D502H-UB-00
155 HP	Commercial	1978~	4.75"	15			MAR-D502H-UB-00
175 Hp	E-Tec®	2008~	4.75"	15	4850-5850	1.86	MAR-D502H-UB-00
175 HP	V6	1977~	4.75"	15	5300-5800	1.86	MAR-D502H-UB-00
185 HP	V6	1984-1985	4.75"	15			MAR-D502H-UB-00
2.6 Liter	V6	1984-1985	4.75"	15			MAR-D502H-UB-00
3.6 Liter	V6	1986-1987	4.75"	15			MAR-D502H-UB-00
200 HP	V6	1976~	4.75"	15	5000-6000	1.86	MAR-D502H-UB-00
200 Hp	E-Tec®	2006~	4.75"	15	4500-5800	1.86	MAR-D502H-UB-00
225 HP	E-Tec®	2006~	4.75"	15	4500-5800	1.86	MAR-D502H-UB-00
225 HP	E-Tec® H.O.	2009~	4.75"	15	4500-5800	1.71	MAR-D502H-UB-00
225 HP	V6	1986~	4.75"	15	5000-6000	1.86	MAR-D502H-UB-00
235 HP	V6	1978-1985	4.75"	15	5000-6000	1.86	MAR-D502H-UB-00
250 HP	V6	1991~	4.75"	15	5000-6000	1.86	MAR-D502H-UB-00
250 HP	E-Tec®	2006~	4.75"	15	4500-5800	1.85	MAR-D502H-UB-00
250 HP	E-Tec® H.O.	2008~	4.75"	15	4500-6000	1.71	MAR-D502H-UB-00
275 HP	V8	1986-1988	4.75"	15	5000-6000	1.86	MAR-D502H-UB-00
300 HP	V8	1988-1995	4.75"	15	5000-6000	1.86	MAR-D502H-UB-00
300 HP	E-Tec®	2009~	4.75"	15	5000-6000	1.86	MAR-D502H-UB-00

## Evinrude® / Johnson® 4-Stroke Hub Applications

Horsepower	Model Notes	Years	Gearcase Diameter	Splines	RPM Range	Gear Ratio	Hub Part Number
40 HP	4-Stroke	1999-2005	3.5"	13	5200-5800	2.27	MAR-C011H-UB-00
50 HP	4-Stroke	1999-2005	3.25"	13	5200-5800	2.27	MAR-C011H-UB-00
60 HP	4-Stroke	1998~	4.25"	13	4700-5300	2.42	MAR-D503H-UB-00
70 HP	4-Stroke	1998~	4.25"	13	5200-5800	2.42	MAR-D503H-UB-00
90 HP	4-Stroke	2003~	4.25"	15	4500-5500	2.59	MAR-D509H-UB-00
115 HP	4-Stroke	2003~	4.25"	15	5000-6000	2.59	MAR-D509H-UB-00
140 HP	4-Stroke	2003~	4.25"	15	5600-6200	2.38	MAR-D501H-UB-00
200 HP	4-Stroke	2004-2005	4.75"	15	5000-6000	2.29	MAR-D502H-UB-00
225 HP	4-Stroke	2004-2005	4.75"	15	5000-6000	2.29	MAR-D502H-UB-00

General Information

Rigging Estimate Guide (Diagrams)

Rigging Components

Electrical Components

Engine Accessories

Propellers

Maintenance Items

Yamaha & Trailer Supplies

Accessories & Apparel

# Propellers

## Suzuki® Hub Applications

Horsepower	Model Notes	Years	Gearcase Diameter	Splines	RPM Range	Gear Ratio	Hub Part Number
DT 35C		1987-1989	3.5"	13			MAR-C011H-UB-00
DT 40		1983-1998	3.5"	13			MAR-C011H-UB-00
DF 40	4-Stroke	1999-2010	3.5"	13	5200-5800	2.27	MAR-C011H-UB-00
DF 40A	4-Stroke	2011~	3.5"	13	5000-6000	2.27	MAR-C011H-UB-00
DT 50		1983-1984	3.5"	13			MAR-C011H-UB-00
DT 50M		1983-1984	3.5"	13			MAR-C011H-UB-00
DF 50	4-Stroke	1999-2010	3.5"	13			MAR-C011H-UB-00
DF 50A	4-Stroke	2011~	3.5"	13			MAR-C011H-UB-00
DT 55		1985-1997	3.5"	13			MAR-C011H-UB-00
DT 60		1983-1984	3.5"	13			MAR-C011H-UB-00
DF 60A	4-Stroke	2010~	3.5"	13	5300-6300	2.27	MAR-C011H-UB-00
DF 60	4-Stroke	1998-2009	4.25"	13	4700-5300	2.42	MAR-C011H-UB-00
DT 65		1985-1997	3.5"	13			MAR-C011H-UB-00
DF 70	4-Stroke	1998-2008	4.25"	13	5200-5800	2.42	MAR-C011H-UB-00
DF 70A	4-Stroke	2009~	4.25"	15	5000-6000	2.59	MAR-D509H-UB-00
DT 75		1983-1997	4.25"	13			MAR-D506H-UB-00
DF 80A	4-Stroke	2009~	4.25"	15	5000-6000	2.59	MAR-D509H-UB-00
DT 85		1979-2000	4.25"	13			MAR-D506H-UB-00
DT 90		1989-1997	4.25"	13			MAR-D506H-UB-00
DF 90	4-Stroke	2001-2008	4.25"	15	4500-5500	2.59	MAR-D509H-UB-00
DF 90A	4-Stroke	2009~	4.25"	15	5300-6300	2.59	MAR-D509H-UB-00
DT 100		1989-2000	4.25"	13			MAR-D506H-UB-00
DF 100	4-Stroke	2009~	4.25"	15			MAR-D509H-UB-00
DT 115		1981-2001	4.25"	13			MAR-D506H-UB-00
DF 115	4-Stroke	2001~	4.25"	15	5000-6000	2.59	MAR-D509H-UB-00
DT 140		1981-2001	4.25"	13			MAR-D506H-UB-00
DF 140	4-Stroke	2002~	4.25"	15	5600-6200	2.59	MAR-D501H-UB-00
DT 150		1986-2003	4.75"	15			MAR-D507H-UB-00
DF 150	4-Stroke	2006~	4.75"	15	5000-6000	2.50	MAR-D507H-UB-00
DT 175		1987-1992	4.75"	15			MAR-D507H-UB-00
DF 175	4-Stroke	2006~	4.75"	15	5500-6100	2.50	MAR-D507H-UB-00
DT 200		1986-2000	4.75"	15			MAR-D507H-UB-00
DF 200	4-Stroke	2004~	4.75"	15	5000-6000	2.29	MAR-D507H-UB-00
DT 225		1986-2003	4.75"	15			MAR-D507H-UB-00
DF 225	4-Stroke	2004~	4.75"	15	5000-6000	2.29	MAR-D507H-UB-00
DF 250	4-Stroke	2004~	4.75"	15	5500-6100	2.29	MAR-D507H-UB-00
DF 300	4-Stroke	2007~	4.75"	15	5700-6300	2.08	MAR-D507H-UB-00

Force® Hub Applications							
Horsepower	Model Notes	Years	Gearcase Diameter	Splines	RPM Range	Gear Ratio	Hub Part Number
40 HP		1995-1998	3.5"	13			MAR-C011H-UB-00
50 HP		1995-1998	3.5"	13			MAR-C011H-UB-00
70 HP		1991-1995	3.5"	13			MAR-C011H-UB-00
75 HP		1996-1998	3.5"	13			MAR-C011H-UB-00
75 HP		1999~	4.25"	15			MAR-D501H-UB-00
85 HP		1988-1989	4.25"	15			MAR-D501H-UB-00
90 HP	L-Drive	1989-1991	4.25"	15			MAR-D501H-UB-00
90 HP		1995-1996	4.25"	15			MAR-D501H-UB-00
90 HP	L-Drive	1990-1991	4.25"	15			MAR-D501H-UB-00
90 HP		1990-1994	4.25"	15			MAR-D501H-UB-00
120 HP	L-Drive	1989-1991	4.25"	15			MAR-D501H-UB-00
120 HP		1995-1996	4.25"	15			MAR-D501H-UB-00
120 HP	L-Drive	1990-1991	4.25"	15			MAR-D501H-UB-00
120 HP		1990-1994	4.25"	15			MAR-D501H-UB-00
125 HP		1988-1989	4.25"	15			MAR-D501H-UB-00
150 HP		1989-1994	4.25"	15			MAR-D501H-UB-00
150 HP	L-Drive	1991	4.25"	15			MAR-D501H-UB-00
150 HP		1989-1994	4.25"	15			MAR-D501H-UB-00
150 HP	L-Drive	1991	4.25"	15			MAR-D501H-UB-00

Nissan® / Tohatsu® Hub Applications							
Horsepower	Model Notes	Years	Gearcase Diameter	Splines	RPM Range	Gear Ratio	Hub Part Number
35 HP	(35B Only)	~1984	3.5"	13			MAR-C013H-UB-00
40 HP	40D	1984~	3.5"	13	4500-5500	1.85	MAR-C013H-UB-00
40 HP	TLDI®	2003~	3.5"	13	5150-5850	1.85	MAR-C013H-UB-00
50 HP	50C	1987-1999	3.5"	13	5000-5700	1.85	MAR-C013H-UB-00
50 HP	includes TLDI®	2000~	3.5"	13	5150-5850	1.85	MAR-C013H-UB-00
55 HP		1981-1988	3.5"	13			MAR-C013H-UB-00
60A		1986-1999	3.5"	13			MAR-C013H-UB-00
60C	(Large Gearcase)	~1999	4.25"	15			MAR-D505H-UB-00
70 HP	70A and 70B	1981-1995	3.5"	13			MAR-C013H-UB-00
70 HP		1992-1997	4.25"	15	4900-5600	2.30	MAR-D505H-UB-00
70 HP	TLDI®	1998~	4.25"	15	5150-5850	2.30	MAR-D505H-UB-00
75 HP	TLDI®	2010~	4.25"	15	5150-5850	2.33	MAR-D505H-UB-00
90 HP		1987-1999	4.25"	15	5000-5500	2.00	MAR-D505H-UB-00
90 HP	TLDI®	2000-2009	4.25"	15	5150-5850	2.00	MAR-D505H-UB-00
90 HP	TLDI®	2010~	4.25"	15	5150-5850	2.33	MAR-D505H-UB-00
115 HP		1992-2002	4.25"	15	5200-5700	2.00	MAR-D505H-UB-00
115 HP	TLDI®	2003~	4.25"	15	5150-5850	2.00	MAR-D505H-UB-00
120 HP		1988-2003	4.25"	15	5200-5700	2.00	MAR-D505H-UB-00
140 HP		1988-2003	4.25"	15	5200-5700	2.00	MAR-D505H-UB-00

General Information

Rigging Estimate Guide (Diagrams)

Rigging Components

Electrical Components

Engine Accessories

**Propellers**

Maintenance Items

Yamalube & Trailer Supplies

Accessories & Apparel

# Propellers

General Information

Rigging Estimate Guide (Diagrams)

Rigging Components

Electrical Components

Engine Accessories

Propellers

Maintenance Items

Yamalube & Trailer Supplies

Accessories & Apparel

## Yamaha 2-Stroke Hub Applications

Horsepower	Model Notes	Years	Gearcase Diameter	Splines	RPM Range	Gear Ratio	Hub Part Number
40 HP	2 Stroke	1984~	3.5"	13	4500-5500	1.85	MAR-C014H-UB-00
48 HP	2 Stroke	1995-2000	3.5"	13	4500-5500	1.85	MAR-C014H-UB-00
50 HP	2 Stroke	1984~	3.5"	13	4500-5500	1.85	MAR-C014H-UB-00
55 HP	2 Stroke	~1995	3.5"	13	4500-5500	1.84	MAR-C014H-UB-00
60 HP	2 Stroke	~1991	3.5"	13	4500-5500	2.33	MAR-C014H-UB-00
60 HP	2 Stroke	1992-2005	4.25"	15	4500-5500	2.00	MAR-D500H-UB-00
70 HP	2 Stroke	2000~	4.25"	15	4500-5500	2.33	MAR-D500H-UB-00
75 HP	2 Stroke	1994-1999	4.25"	15	4500-5500	2.00	MAR-D500H-UB-00
80 HP	2 Stroke	1997	4.25"	15	4500-5500	2.00	MAR-D500H-UB-00
85 HP	2 Stroke	1991-1997	4.25"	15	4500-5500	2.00	MAR-D500H-UB-00
90 HP	2 Stroke	1984~	4.25"	15	4500-5500	2.00	MAR-D500H-UB-00
115 HP	2 Stroke	1984~	4.25"	15	4500-5500	2.00	MAR-D505H-UB-00
130 HP	2 Stroke	1984-2003	4.25"	15	4500-5500	2.00	MAR-D505H-UB-00
150 HP	2 Stroke	1986~	4.75"	15	4500-5500	2.00	MAR-D505H-UB-00
175 HP	2 Stroke	1984~	4.75"	15	4500-5500	1.86	MAR-D505H-UB-00
200 HP	2 Stroke	1984~	4.75"	15	4500-5500	1.86	MAR-D505H-UB-00
220 HP	(Special)	1984-1985	4.75"	15	4500-5500	1.75	MAR-D505H-UB-00
225 HP	2 Stroke	1986~	4.75"	15	4500-5500	1.75	MAR-D505H-UB-00
225 HP	(Excel) 2 Stroke	1987-1988	4.75"	15	4500-5500	1.75	MAR-D505H-UB-00
250 HP	2 Stroke	1990~	4.75"	15	4500-5500	1.75	MAR-D505H-UB-00
2.6L	VMAX® 2 Stroke	2001~	4.75"	15	4500-5500	1.86	MAR-D505H-UB-00
3.3L	VMAX® 2 Stroke	2001~	4.75"	15	4500-5500	1.75	MAR-D505H-UB-00

## Yamaha 4-Stroke Hub Applications

Horsepower	Model Notes	Years	Gearcase Diameter	Splines	RPM Range	Gear Ratio	Hub Part Number
T25	4-Stroke		3.5"	13	5000-6000		MAR-C014H-UB-00
F30	4-Stroke	2001-2005	3.5"	13	5000-6000	2.00	MAR-C014H-UB-00
F40	4-Stroke	1999~	3.5"	13	5000-6000	2.00	MAR-C014H-UB-00
F50	4-Stroke	1995~	3.5"	13	5000-6000	1.85	MAR-C014H-UB-00
T50	4-Stroke	1996~	4.25"	15	5000-6000	2.33	MAR-D500H-UB-00
F60	4-Stroke	1999~	3.5"	13	5000-6000	1.85	MAR-C014H-UB-00
T60	4-Stroke	1999~	4.25"	15	5000-6000	2.33	MAR-D500H-UB-00
F70	4-Stroke	2010~	4.25"	15	5300-6300	2.33	MAR-D500H-UB-00
F75	4-Stroke	2003~	4.25"	15	5000-6000	2.31	MAR-D500H-UB-00
F80	4-Stroke	1999-2002	4.25"	15	5000-6000	2.31	MAR-D500H-UB-00
F90	4-Stroke	1999-2017	4.25"	15	5000-6000	2.00	MAR-D500H-UB-00
F90	4-Stroke	2017~	4.25"	15	5000-6000	2.00	MAR-D505H-UB-00
F100	4-Stroke	1999-2002	4.25"	15	5000-6000	2.31	MAR-D500H-UB-00
F115	4-Stroke	2000~	4.25"	15	5000-6000	2.15	MAR-D505H-UB-00
F150	4-Stroke	2004~	4.75"	15	5000-6000	2.0	MAR-D505H-UB-00
F200	4-Stroke	2002~	4.75"	15	5000-6000	2.0	MAR-D505H-UB-00
VF200	V MAX® SHO® 4-Stroke	2010~	4.75"	15	5000-6000	1.75	MAR-D505H-UB-00

## Yamaha 4-Stroke Hub Applications Continued...

Horsepower	Model Notes	Years	Gearcase Diameter	Splines	RPM Range	Gear Ratio	Hub Part Number
F225	4-Stroke	2002~	4.75"	15	5000-6000	2	MAR-D505H-UB-00
VF225	V MAX® SHO® 4 Stroke	2010~	4.75"	15	5000-6000	1.75	MAR-D505H-UB-00
F225	4 Stroke Offshore	2010~	4.75"	15	5000-6000	1.75	MAR-D505H-UB-00
F250	4-Stroke	2002~	4.75"	15	5000-6000	2.00	MAR-D505H-UB-00
F250	4 Stroke Offshore	2010~	4.75"	15	5000-6000	1.75	MAR-D505H-UB-00
VF250	V MAX® SHO® 4 Stroke	2010~	4.75"	15	5000-6000	1.75	MAR-D505H-UB-00
F300	4 Stroke Offshore	2010~	4.75"	15	5000-6000	1.75	MAR-D505H-UB-00

General Information

Rigging Estimate Guide (Diagrams)

Rigging Components

Electrical Components

Engine Accessories

**Propellers**

Maintenance Items

Yamaha & Trailer Supplies

Accessories & Apparel



## Propeller Hardware Kits

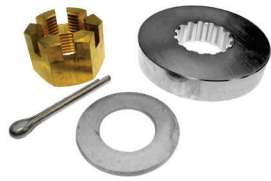

**6G5-W4599-00-00**

Castle Nut	90171-18M04-00
Cotter Pin	91490-40030-00
Rear Spacer	688-45997-01-00
Washer	92990-18200-00

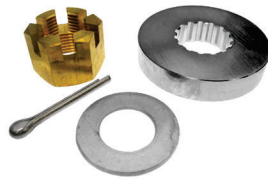

**6H1-W4599-00-00**

Castle Nut	90171-16011-00
Cotter Pin	91490-30030-00
Rear Spacer	688-45997-01-00
Washer	90201-17M00-00

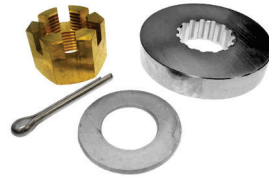

**6H4-W4599-00-00**

Castle Nut	90171-16011-00
Cotter Pin	91490-30030-00
Rear Spacer	670-45997-02-00
Washer	92990-16200-00



**66T-W4599-00-00**

Bushing	90389-22M01-00
Rear Spacer	66T-45997-00-00
Cotter Pin	91490-30030-00
Castle Nut	90171-16011-00



**67F-W4599-00-00**

Castle Nut	90171-16011-00
Bushing	90389-25M00-00
Rear Spacer	67F-45997-00-00
Cotter Pin	91490-40030-00



**647-W4599-00-00**

Propeller Nut	647-45616-02-00
Cotter Pin	91490-30030-00

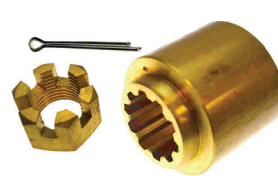

**689-W4599-00-00**

Castle Nut	90171-14013-00
Rear Spacer	689-45997-00-00
Cotter Pin	91490-30030-00
Washer	92990-14200-00

4-Stroke Propeller Hardware Kit Application	Kit Part Number
F25	689-W4599-00-00
F30, F40 (00~), F40LA	66T-W4599-00-00
F40 (99)	6H4-W4599-00-00
F50 (01~)	66T-W4599-00-00
F50 (95~00)	6H4-W4599-00-00
T50 (96~00)	6H1-W4599-00-00
T50 (01~)	67F-W4599-00-00
F60 (03~)	66T-W4599-00-00
T60 (03~)	67F-W4599-00-00
F70	67F-W4599-00-00
F75, F90 (03~)	67F-W4599-00-00
F80, F100	67F-W4599-00-00
F115~F300(4.2L)	6G5-W4599-00-00
VF115~VF250	6G5-W4599-00-00

2-Stroke Propeller Hardware Kit Application	Kit Part Number
4, 5 (84~91)	647-W4599-00-00
20,25, C25, CV25, 30, C30, CV30	689-W4599-00-00
40 (84~01), P40, P50, Pro50	6H4-W4599-00-00
C40, C50, C55, CV40, CV55, E48	6H4-W4599-00-00
50	6H4-W4599-00-00
60~90 (~03)	6H1-W4599-00-00
60~90 (04~)	67F-W4599-00-00
C60~C90, E60, P60, E75, P75	6H1-W4599-00-00
CV85, B90	6H1-W4599-00-00
B115	6G5-W4599-00-00
115~250, C115, C150	6G5-W4599-00-00
P115~P200, PX175	6G5-W4599-00-00
S115~S250	6G5-W4599-00-00
D150, DX150, ProV150	6G5-W4599-00-00
SX150~SX250, V150~V225	6G5-W4599-00-00
VX150~VX250	6G5-W4599-00-00
VZ150~VZ300	6G5-W4599-00-00
Z150~Z300	6G5-W4599-00-00

## Propeller Accessories

### Propeller Cover

Constructed of 600D, solution-dyed polyester for durability and fade resistance.

**MAR-PROPB-AG-BK**



### F300-F90 (pre 2018) – 6CE-45997-00-00

Early SDS washers used mechanical stops in the washer and are easily identifiable by the cutouts in the propeller and the distinct shape of the washer. This was designed specifically for the notches in the propeller.

**6CE-45997-00-00**



### V6 F350-F90 (post 2018)

Early SDS washers used mechanical stops in the washer and are easily identifiable by the cutouts in the propeller and the distinct shape of the washer. This was designed specifically for the notches in the propeller.

**688-45997-01-00**



### V8 F350 (pre 2015)

Early SDS washers used mechanical stops in the washer and are easily identifiable by the cutouts in the propeller and the distinct shape of the washer. This was designed specifically for the notches in the propeller.

**6AW-45997-10-00**



### V8 F350 (post 2015)

The SDS spacer was redesigned to a solid circle. The outside diameter of this washer is 2.5 in / 64.6 mm and is only used in F350 applications.

**6AW-45997-00-00**



### XTO Offshore

The SDS spacer was designed as a solid circle washer. The outside diameter of this washer is 2.9 in / 75.7 mm and is only used in XF425 and XF450 applications.

**6GR-45997-00-00**



### Two Piece Thrust Washer:

Used in place of a standard thrust washer on most VZ and VF engines.

**99999-03848-00**

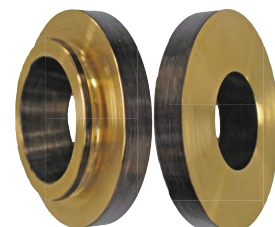

\*Specifically designed to be used with Yamaha VMAX SHO & Turbo FXP series



<b>Description</b>	<b>Page</b>
Maintenance Capacities Chart	7-1
4-Stroke Spark Plugs	7-3
2-Stroke Spark Plugs	7-5
4-Stroke Oil Filters	7-6
2-Stroke Oil Strainers	7-7
In Line Fuel Filters	7-8
Primary Fuel Filters	7-9
Remote Mounted Fuel Filters	7-11
Vapor Separator Tank (VST) Fuel Filters	7-12
VST Gaskets	7-13
Engine Timing Belts	7-14
Trim Tabs	7-15
Anodes/Anode Kits	7-16
Thermostats	7-17
Thermostat Gaskets	7-18
4-Stroke Carburetor Repair Kits	7-19
2-Stroke Carburetor Repair Kits	7-23
Water Pump Housings	7-29
4-Stroke Water Pump Repair Kits	7-30
2-Stroke Water Pump Repair Kits	7-34
All-New 100-Hour Service Kit	7-40

General  
Information

Rigging Estimate  
Guide (Diagrams)

Rigging  
Components

Electrical  
Components

Engine  
Accessories

Propellers

**Maintenance  
Items**

Yamaha &  
Trailer Supplies

Accessories  
& Apparel

# Maintenance Items

## Maintenance Capacities Chart

Model	Production Year	Oil Change Capacity:	Oil Filter Part #	(NGK®) Spark Plug	5W30 4M	10W30 4M	20W40 4M	Gear Case Capacity in Ounces
F2.5	2005~	10 US OZ.	N/A	BR6HS-10	✓	✓	✓	2.5
F4	2005~	17 US OZ.	N/A	BR6HS-10	✓	✓	✓	3.5
F4A / F6A	2010~	20 US OZ	N/A	CR6HSB7	✓	✓	✓	4.0
F6 / F8C / T8D	2005~	27 US OZ.	N/A	BR6HS-10	✓	✓	✓	F6 / F8 = 5.1 T8 = 12.5
New F8 "S"	2015~	27 US OZ	N/A	BR6HS-10	✓	✓	✓	5.1
New F8 "L"	2015~	27 US OZ	N/A	BR6HS-10	✓	✓	✓	5.1
F9.9F / T9.9G	2008~	27 US OZ.	N/A	BR6HS-10	✓	✓	✓	F9.9F = 5.1 T9.9G = 12.5
F15C / F20	2007~	1.9 US QT	5GH-13440-80-00	DPR6EA-9	✓	✓	✓	8.5
F25A / T25A	2009~	1.7 US QT	5GH-13440-80-00	DPR6EA-9	✓	✓	✓	F25 = 11 T25 = 15
F25	2017~	1.2 US QT	5GH-13440-80-00	DPR6EB-9	✓	✓	✓	F25 = 11
F25C / T25C	2024~	1.2 US QT	5GH-13440-80-00	DPR6EB-9	✓	✓	✓	12.5
F40A	2009~	1.8 US QT	5GH-13440-80-00	DPR6EB-9	✓	✓	✓	15
F50 / T50 / F60 / T60	2005~	2.2 US QT	5GH-13440-80-00	DPR6EB-9	✓	✓	✓	F50 / F60 = 14.5 T50 / T60 = 22.7
F70LA	2010~	2.2 US QT	5GH-13440-80-00	LKR7E	✓	✓	✓	22.7
F75 / F90	2005~	3.9 US QT	5GH-13440-71-00	LFR5A-11	✓	✓	✓	22.7
F90B	2016~	3.4 US QT	5GH-13440-71-00	LKR6E	✓	✓	✓	26
VF90	2017	3.4 US QT	5GH-13440-71-00	LKR6E	✓	✓	✓	26
F115	2000~	3.9 US QT	5GH-13440-71-00	LFR6A-11	✓	✓	✓	RH Rotation = 25.7 LH Rotation = 24.2
F115	2014~	3.38 US QT	5GH-13440-71-00	LKR6E	✓	✓	✓	RH Rotation = 25.7 LH Rotation = 24.2
VF115	2015~	3.38 US QT	5GH-13440-71-00	LKR6E	✓	✓	✓	25.7
F150	2004~	4.7 US QT	69J-13440-04-00	LFR5A-11	✓	✓	✓	RH Rotation = 33.1 LH Rotation = 29.4
F150B	2015~	4.8 US QT	69J-13440-04-00	LFR5A-11	✓	✓	✓	RH Rotation = 33.1 LH Rotation = 29.4
VF150	2013~	4.8 US QT	69J-13440-04-00	LFR6A-11	✓	✓	⊘	33.1
F175	2014~	4.8 US QT	69J-13440-04-00	LFR6A-11	✓	✓	✓	33.2
VF175	2015~	4.8 US QT	69J-13440-04-00	LFR6A-11	✓	✓	⊘	33.1

This chart is provided for reference only, always refer to the proper service manual for the most accurate information.

## Maintenance Capacities Chart

Model	Production Year	Oil Change Capacity:	Oil Filter Part #	(NGK®) Spark Plug	5W30 4M	10W30 4M	20W40 4M	Gear Case Capacity in Ounces
F200 (Inline 4 Cyl)	2013~	4.7 US QT	69J-13440-04-00	LFR6A-11	✓	✓	✓	RH Rotation = 33.2 LH Rotation = 33.2
F200 / F225 (V6)	2002~	5.0 US QT	69J-13440-04-00	LFR5A-11	✓	✓	✓	RH Rotation = 38.9 LH Rotation = 33.8
VF200 / VF225 / VF250	2010~	7.1 US QT	N26-13440-03-00	LFR6A-11	✓	✓	⊘	36
VF250XA	2015~	7.1 US QT	N26-13440-03-00	LFR6A-12	✓	✓	⊘	35.2
F225CA / F250CA / F300CA	2010~	6.7 US QT	N26-13440-03-00	LFR6A-11	✓	✓	✓	35.2
F225 Sport	2008~	5.0 US QT	69J-13440-04-00	LFR6A-11	✓	✓	✓	31.1
F250 (A & B)	2005~	5.0 US QT	69J-13440-04-00	LFR6A-11	✓	✓	✓	RH Rotation = 31.1 LH Rotation = 27.2
F350 (V6)	2024~	8.3 US QT	N26-13440-03-00	ILMAR7E9	✓	✓	✓	RH Rotation = 31.3 LH Rotation = 29.9
F300 / F350	2008~	6.8 US QT	N26-13440-03-00	LFR6A-11	✓	✓	✓	RH Rotation = 51.4 LH Rotation = 44.3
XF425	2018~	8.2 US QT	N26-13440-03-00	ILMAR7E9	✓	✓	✓	RH Rotation = 65.9 LH Rotation = 61.8
XF450	2023~	8.2 US QT	N26-13440-03-00	ILMAR7E9	✓	✓	✓	RH Rotation = 65.9 LH Rotation = 61.8

General Information

Rigging Estimate Guide (Diagrams)

Rigging Components

Electrical Components

Engine Accessories

Propellers

**Maintenance Items**

Yamaha & Trailer Supplies

Accessories & Apparel

## 4-Stroke Spark Plugs

Four Stroke Model	NGK® Number	Gap (mm)	Gap (in)	Yamaha Part Number	Qty.
F4A / F6A	CR6HSB	0.7	0.028	CR6-HSB00-00-00	10
F6	BR6HS-10	1.0	0.04	BR6-HS100-00-00	10
F8 / T8 / New F8	BR6HS-10	1.0	0.04	BR6-HS100-00-00	10
New F8 "L"	BR6HS-10	1.0	0.039	BR6-HS100-00-00	10
F9.9 / FT9.9 / T9.9 (85~03) cold climates	CR4HSA	0.6	0.024	CR4-HSA00-00-00	10
F9.9 / FT9.9 / T9.9 (85~04)	CR6HS	0.6	0.024	CR6-HS000-00-00	10
F9.9 / T9.9 / FT 9.9 (05~)	DPR6EA-9	0.8	0.032	DPR-6EA90-00-00	10
F9.9F / T9.9G	BR6HS-10	1.0	0.04	BR6-HS100-00-00	10
F15	DPR6EA-9	0.8	0.032	DPR-6EA90-00-00	10
F20 / F15C	DPR6EB-9	0.9	0.036	DPR-6EB90-00-00	10
F25 (98~05)	DPR6EA-9	1.0	0.039	DPR-6EA90-00-00	10
T25 (01~06) / F25 (06~) / F30 (01~05)	DPR6EA-9	0.9	0.036	DPR-6EA90-00-00	10
F25A/T25A	DPR6EB-9	0.9	0.036	DPR-6EB90-00-00	10
F25C / T25C	DPR6EB-9	0.9	0.036	DPR-6EB90-00-00	10
F40	DPR6EA-9	0.9	0.036	DPR-6EA90-00-00	10
F40A	DPR6EB-9	0.9	0.036	DPR-6EB90-00-00	10
F50 / T50 (95~04) / F60 / T60 (~04)	DPR6EA-9	0.9	0.036	DPR-6EA90-00-00	10
F50 / T50 (05~) / F60 / T60 (05~)	DPR6EB-9	0.9	0.036	DPR-6EB90-00-00	10
F70A	LKR7E	0.9	0.035	LKR-7E000-00-00	10
F75 / F80 / F90 / F100	LFR5A-11	1.1	0.044	LFR-5A110-00-00	10
F90B	LKR6E	0.9	0.035	LKR6-E000-00-00	10
VF90	LKR6E	0.9	0.035	LKR6-E000-00-00	10
F115 / LF115	LFR6A-11	1.1	0.044	LFR-6A110-00-00	10
F115	LKR6E	0.9	0.035	LKR-6E000-00-00	10
VF115	LKR6E	0.9	0.035	LKR-6E000-00-00	10
F150 / F150B	LFR5A-11	1.0	0.039	LFR-5A110-00-00	4
VF150 / F175 / VF175 / F200 (inline)	LFR6A-11	1.1	0.043	LFR-6A110-00-00	4
F200 / F225 (V6)	LFR5A-11	1.0	0.04	LFR-5A110-00-00	4

\*Ordered individually with a minimum order quantity



NGK® Spark Plugs are used in all of the Yamaha Outboards you service throughout the year. Since 1936 NGK® has lead the industry in technology, innovation and world class design of its entire product line. You can depend on NGK® for quality and reliability.

4-Stroke Spark Plugs

Four Stroke Model	NGK® Number	Gap (mm)	Gap (in)	Yamaha Part Number	Qty.
VF200 / VF225 / VF250	LFR6A-11	1.1	0.043	LFR-6A110-00-00	4
New VF250"X"	LFR6A-11	1.1	0.043	LFR-6A110-00-00	4
F250 / LF250 / F250B / LF250B	LFR6A-11	1.1	0.044	LFR-6A110-00-00	4
4.2L- F225 / LF225 / F250 / LF250 / F300 / LF300	LFR6A-11	1.1	0.043	LFR-6A110-00-00	4
4.3L- F350 (V6)	ILMAR7E9	0.8	0.035	LMA-R7E90-00-00	6
V8- F300 / LF300 / F350 / LF350	LFR6A-11	1.1	0.044	LFR-6A110-00-00	4
XF425	ILMARE9	N/A	N/A	LMA-R7E90-00-00	4
XF450	ILMAR7H9	N/A	N/A	94702-00447-00	8

\*Ordered individually with a minimum order quantity

- General Information
- Rigging Estimate Guide (Diagrams)
- Rigging Components
- Electrical Components
- Engine Accessories
- Propellers
- Maintenance Items**
- Yamaha & Trailer Supplies
- Accessories & Apparel

NGK® Spark Plugs are used in all of the Yamaha Outboards you service throughout the year. Since 1936 NGK® has lead the industry in technology, innovation and world class design of its entire product line. You can depend on NGK® for quality and reliability.





## 2-Stroke Spark Plugs

Two Stroke Model	NGK® Number	Gap (mm)	Gap (in)	Yamaha Part Number	Qty.
2	B5HS	0.6	0.024	Discontinued	
3	B6HS-10	0.9	0.036	BR6-HS100-00-00	10
4, 5	B7HS	0.6	0.024	BR7-HS100-00-00	10
6, 8	B7HS-10	0.9	0.036	BR7-HS100-00-00	10
9.9 / 15 / 20 / 25	B7HS-10	1	0.04	B7H-S0000-00-00	4
C25 (90~97) / 30 (84~86) / C30 (89~92)	B7HS	0.6	0.024	B7H-S0000-00-00	4
30 (87~02)	B7HS-10	1	0.04	BR7-HS100-00-00	10
C30 (93~97)	B8HS-10	1	0.04	B8H-S1000-00-00	4
40 (84 ~ 05) / C40 (97 ~ 02)	B7HS-10	1	0.04	BR7-HS100-00-00	10
C40 (89~97)	B8HS	0.6	0.024	BR8-HS000-00-00	4
E48 (95~00)	B7HS	1	0.04	B7H-S0000-00-00	4
50 / P50 / C55	B8HS-10	1	0.04	B8H-S1000-00-00	4
C50	B8HS	0.6	0.024	BR8-HS000-00-00	4
60 / C60 / E60 / P60 / 70 / C70 / C75 / E75 / P75	B8HS-10	1	0.04	B8H-S1000-00-00	4
C80, C85, 90, B90, C90	B8HS-10	1	0.04	B8H-S1000-00-000	4
115 / B115 / C115 / P115 / S115	BR8HS-10	1	0.04	BR8-HS100-00-00	4
130 / L130 / S130	BR9HS-10	1	0.04	BR9-HS100-00-00	10
150 (~87) / 150 / SX150 / LX150 (96~) / S150 (99~)	BR7HS-10	1	0.04	BR7-HS100-00-00	10
C150 (96), DX (99~) / P150(96~) / PX150, V150 (00~)	BR7HS-10	1	0.04	BR7-HS100-00-00	10
150 / L150 (88~95) / C150 (97~)	BR8HS-10	1	0.04	BR8-HS100-00-00	4
D150 (97~99) / P150 (86~95)	BR8HS-10	1	0.04	BR8-HS100-00-00	4
VZ150 (~01) / Z150 / LZ150 (~01)	BKR6ES-11	Note 2	Note 2	BKR-6ES11-00-00	4
VZ150 (01~) / Z150 / LZ150 (01~)	BKR6E-KU	Note 2	Note 2	BKR-6EKU1-00-00	4
175 / S175 / V175 / P175	BR8HS-10	1	0.04	BR8-HS100-00-00	4
VZ175 (01~) / Z175/LZ175 (01~) / Z200/LZ200 (01~)	BKR7E-KU	Note 2	Note 2	BKR-7EKU1-00-00	4
VZ175 (01) / Z175 / LZ175 (01) / Z200 / LZ200 (~01)	BKR7ES-11	Note 2	Note 2	BKR-7ES11-40-00	4
200 / S200 / SX200 / LX200 / V200 / VX200 / P200 (96 ~)	BR8HS-10	1	0.04	BR8-HS100-00-00	4
VZ200 (05~) VZ225 / VZ250 / VZ300	BKR6E-KU	Note 3	Note 3	BKR-6EKU1-00-00	4
225 2.6L (~95) / L225/S225 3.L (97~) / LX225/SX225	BR9HS-10	1	0.04	BR9-HS100-00-00	10
225/L225 3.1L (~96) / S225 3.1L (96) / 225 2.6L (96~)	BR8HS-10	1	0.04	BR8-HS100-00-00	4
V225 / VX225 / P200 (91~95)	BR9HS-10	1	0.04	BR9-HS100-00-00	10
S250 / L250 (97~) / SX250 / LX250 / VX250	BR9HS-10	1	0.04	BR9-HS100-00-00	10
250/L250 (90~95) / S250 (96) B	BR8HS-10	1	0.04	BR8-HS100-00-00	4
LZ250 / Z250 / Z300 / LZ300	BKR6E-KU	Note 3	Note 3	BKR-6EKU1-00-00	4
V6 Excel	BR9HS-10	1	0.04	BR9-HS100-00-00	10
V6 Spec	BR8HS-10	1	0.04	BR8-HS100-00-00	4

\*Ordered individually with a minimum order quantity

Note 1: All NGK® spark plugs for Yamaha Outboards are sold in 10 packs. (Ordering 10 spark plugs will be equal to one box)

Note 2: Refer to Technical Bulletin O2000-015A to ensure the correct spark plug and gap are used.

Note 3: Refer to Technical Bulletin O2003-016 to ensure the correct spark plug and gap are used.

4-Stroke Oil Filters



**3FV-13440-30-00**

- F25 / F15 (1998-1999)
- F40 (1999-2000)
- T50 (1996-1999)
- F50 (1995-1999)
- F80 / F100 (1999)



**5GH-13440-80-00**

- F25C / T25C
- F15C / F20
- F25 (04/2009 ~)
- F40A (2001~)
- F50 / T50 (2005~)
- F60 / T60 (2005~)
- F70



**5GH-13440-71-00**

- F15 (2000~2005)
- F30 / F40 / F40B
- F50 / T50 (1999-2004)
- F60 / T60 (1999-2004)
- F75 / F90 / F115
- T25 / F25 (2000-04/2006)
- T9.9 / F9.9 (2005 - 04/06)
- F80 / F100 (2000~)
- F90
- VF90



**69J-13440-04-00**

- F150
- VF150
- F200 (Inline)
- F200 / F225 (V6)
- F250 / F250B



**N26-13440-03-00**

- F225C / F250C / F300 (4.2L)
- F300 / F350 (V8)
- F350 (V6)
- VF200 / VF225 / VF250 (4.2L)
- XTO® 425 / 450

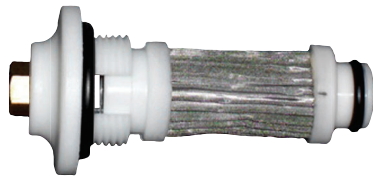

**6G8-13440-00-00**

- F9.9 (1990 - 04/05)
- T9.9 (1991 - 04/05)



**Oil Drain Screw Gasket**  
Used on most Yamaha 4-Stroke Models.  
**90430-14M09-00 Qty 1**  
**6FM-WB008-00-00 Qty 50**



**Oil Drain Screw**  
Used on most Yamaha 4-Stroke Models.  
**90340-14M06-00**

**Why Yamaha Oil Filters?**  
Customers come to your dealership for the service they trust. Why risk that on an aftermarket filtration element and cardboard filter ends? Yamaha oil filters are constructed with molded high quality media for long life and superior filtration.

## 2-Stroke Oil Strainers



### 6E5-13411-00-00

115 / 130 / 150 / 175 / 200

B115 / D150 / DX150 / PX150

ProV150 / V6 EXCEL

P115 / P150 / P175 / P200

S115 / S130 / S150 / S175 / S200

SX150 / SX200

V150 / VX150 / V175

VZ150 / VZ175 / VZ200 (2.6L)

Z150 / Z175 / Z200



### 6J8-13411-00-00

20 / 25 / 30 (89~)

40 / 50 / 60 / 70 (89~)

C30 (89~)

P40 / P50 / P60 (89~)

Pro50



### 61A-13411-00-00

V200 / V225

VX200 / VX225 / VX250

VZ200 / VZ225 (3.3L)

VZ250 / VZ300 (3.3L)

S225 / SX225 / S250 / SX250

250 (90~95)

Z250 / Z300



### 6H1-13411-00-00

90 (89~)

C90 / B90 (89~)



### Electric Oil Pump Strainer

Used on all HPDI engines between the engine oil tank and the electric oil pump.

**68F-13440-00-00**



### Remote Oil Tank Filter

Remote oil tank filters are regularly missed during yearly service. Replacing the filter during the service can help prevent issues later down the road.

**646-24251-02-00**

General Information

Rigging Estimate Guide (Diagrams)

Rigging Components

Electrical Components

Engine Accessories

Propellers

**Maintenance Items**

Yamalube & Trailer Supplies

Accessories & Apparel

In Line Fuel Filters



**646-24251-02-00**

- 4 (97~99)
- F4 (99~06/2008)
- 5 (97~01)
- 6 (86~00)
- 8
- F9.9 (85~04/2005)
- T9.9 (91~04/2005)



**60V-24251-01-00**

- Z150 / Z175
- Z200 / Z225
- Z250 / Z300
- VZ150 / VZ175 / VZ200
- VZ225 / VZ250 / VZ300



**6C5-24251-01-00**

- F25C / T25C
- F40 (EFI)
- F50 / F60 (05~)
- T50 / T60 (05~)
- F70
- F75 / F90 (05~)
- F90B
- VF90



**68T-24251-01-00**

- F4 / F6 (09/2009~)
- F6 (01~04/2006)
- F8 / T8 (01~)
- F9.9 / T9.9G (04/2007~)



**65W-24251-10-00**

- F30 (05~)
- F40 (05~)



**67F-24251-02-00**

- F80
- F100



**67F-14371-01-00**

- F80 (Carb Inlet)
- F100 (Carb Inlet)



**6L5-24251-00-00**

- F2.5 (03~)
- 3 (92~02)
- F4 (99~06/2008)



**6AW-24502-11-00**

- F300 (V8)
- F350 (V8)



**68V-24502-30-00**

- F115 (04/2010~)



**68V-24502-03-00**

- F115 (~03/2010)

## In Line Fuel Filters

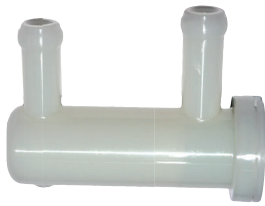

**69J-24501-00-00**

F150 (~05)  
F200 V6 (~05)  
F225 (~05)

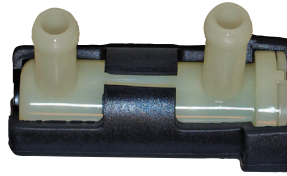

**69J-24502-00-00**

F70 (05~)  
F90 (05~)  
F150 (05~)  
F200 / F225 V6 (05~)

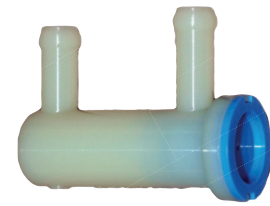

**69J-24501-10-00**

F150 (04/2005~)  
F200 / F225 V6 (04/2005~)  
F250 / F250B

## Primary Fuel Filters

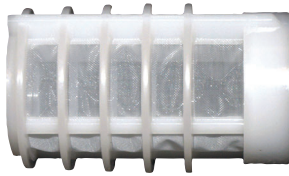

**61N-24563-10-00**

9.9 / 15 / 20 / 25 / C25 (94~)  
F9.9 / T9.9 (05~04/2006)  
F15 / F20 / F25 / T25 (05~)  
30 / 40 / 50 / 70 / 90 (94~)  
C30 / C40 / C50 / C55 / C70 (94~)  
P40 / P50 / P60 / P75 (94~)  
F40 (99)  
E48 / E60 / E75  
F50 / T50 (95~04)  
F60 / T60 (04~04/2005)  
C75 / C80 / C85 / C90 (94~)  
F75 (03~04) / F90 (03~04)  
F80, / F100 / B90 / B115  
115 / 130 / 150 / 175 (94~)  
C115 (94~96)  
P115 / P150 / P175 / P200 (94~)  
S115 / S130 / S150 / S175 / S200  
D150 / V150 / V175

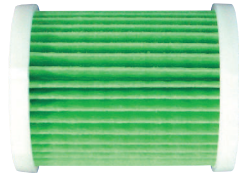

**6P3-WS24A-02-00**

VZ150 / VZ175 (04/2006~)  
Z200 / Z300 (04/2006~)  
VZ200 / VZ225 (04/2006~)  
VZ250 / VZ300 (04/2006~)  
F150 / F200 / F225 (04/2006~)  
F250 / F250B (04/2006~)  
VF200 / VF225 / VF250 (4.2L)  
F225C / F250C / F300C (4.2L)  
F350 (V6)  
F300 / F350 (V8)  
XTO® 425 / 450



**6F5-24563-00-00**

9.9 / 15 (~93)  
25 / 30 / 40 / 50 / 70 / 90 (~93)  
C25 / C30 / C40 / C55 / C85 (~93)  
CV25 / CV30  
CV40 / CV50 / CV85  
P50 / P60 (~93)  
PRO50  
115 / 130 / 150 / 175 (~93)  
200 / 225 (~93)  
C115 (~93)  
P115 / P150 / P200 (~93)  
ProV150  
V6 Special / V6 Excel

General Information

Rigging Estimate Guide (Diagrams)

Rigging Components

Electrical Components

Engine Accessories

Propellers

**Maintenance Items**

Yamalube & Trailer Supplies

Accessories & Apparel

Primary Fuel Filters

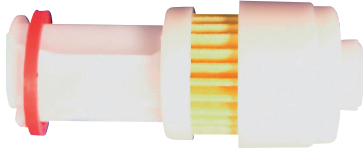

**65L-24563-00-00**  
 SX150 / SX200 / SX225, SX250  
 VX150 / DX150 / PX150  
 F150 / F200 / F225 (~04/2005)  
 V200 / V225  
 VX200 / VX225 / VX250  
 S225 / S250 (97~99)

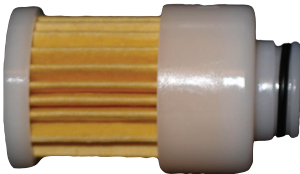

**68V-24563-00-00**  
 F50 / T50 (05~04/2006)  
 F60 / T60 (04/2005~)  
 F75 / F90 (05~04/2006)  
 F115 (~04/2006)

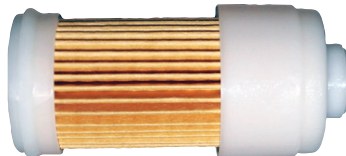

**68F-24563-10-00**  
 VZ150 / VZ175 (05~04/2005)  
 VZ200 (05~04/2005)  
 Z150 / Z175 (05~04/2005)  
 Z200 / Z250 (05~04/2005)  
 VZ225 / VZ250 (05~04/2005)  
 VZ300 / Z300 (04~04/2005)

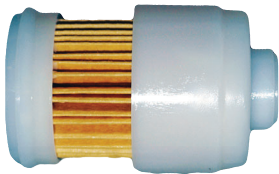

**68F-24563-01-00**  
 VZ150 / VZ175 / VZ200 (~04)  
 Z150 / Z175 / Z200 / Z250 (~04)  
 VZ225 / VZ250 (~04)

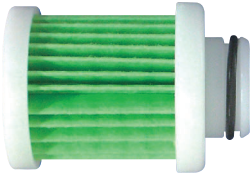

**6D8-WS24A-00-00**  
 F25C / T25C  
 F40A  
 F50/T50 / F60/T60 (04/2006~)  
 F70  
 F75 / F90 / F115 (04/2006~)  
 F90B  
 VF90



**61A-24563-02-00**  
 S225 / S250 (96)  
 C115 / C150 (97~)

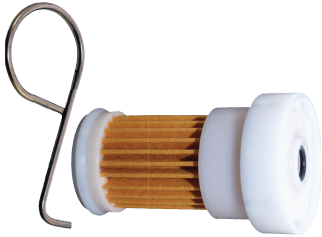

**6P2-WS245-00-00**  
 F250 (2005~04/05)

General Information

Rigging Estimate Guide (Diagrams)

Rigging Components

Electrical Components

Engine Accessories

Propellers

Maintenance Items

Yamaha & Trailer Supplies

Accessories & Apparel

## Remote Mounted Fuel Filters



### 10-Micron Fuel/Water Separating Filter

They are a primary line of defense against ethanol-related fuel system issues. Highly recommended for all two stroke and four stroke EFI outboards and two stroke HPDI's. Also excellent for carbureted engines. New, improved 10-micron filter provides superior filtration ahead of the engine's onboard filters and injectors. Large filtering and water capture areas maximize filtration while maintaining adequate flow rate for larger engines.

#### Assemblies

Assembly Stainless Steel Head **MAR-10MAS-10-00**

Assembly Stainless Steel Head 3/8" Fittings **MAR-10MAS-20-00**

Assembly Aluminum Head **MAR-10MAS-00-00**

#### Elements

Spin-On Filter Only **MAR-10MEL-00-00**

Bulk pack of 12 **MAR-10MEL-00-BK**

#### Filter Heads

Aluminum Filter Head 12 Pack **MAR-FLTHD-00-BK**

Stainless Steel Filter Head 12 Pack **MAR-FLTHD-10-BK**

Stainless Steel Filter Head 3/8" Fittings 12 Pack  
**MAR-FLTHD-20-BK**

#### Mini-10™

Assembly Aluminum Head **MAR-M10AS-00-00**

Spin-On Filter only **MAR-M10EL-00-00**

#### Brass Plugs

1/4" Brass Plug (fits all except 3/8") **MAR-BRASP-LG-14**

3/8" Brass Plug **MAR-BRASP-LG-38**



### Yamaha Remote Filter Elements and Bowls

Replacement filter elements and filter bowls for boats rigged with a water sensor probe. Requires Yamaha Multifunction Fuel Management Gauge for water detection indication. Complete assembly not available.

#### Filter Bowls

Replacement Water Probe **MAR-10171-30-00**

\*For above deck use only

Vapor Separator Tank (VST) Fuel Filters



66K-13915-00-00  
SX150 / SX200 / SX225 / SX250  
DX150 / PX150  
VX150 / VX200 / VX225 / VX250  
S225 / S250 / V200 / V225 (99~)



6CB-24501-00-00  
VF200 / VF225 / VF250 (4.2L)  
F200 (2.8L)  
F225 / F250 / F300 (4.2L)  
F350 (V6)

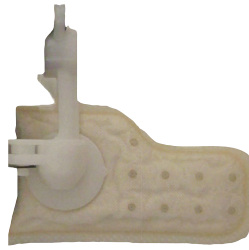

6CB-24501-01-00  
F40 EFI

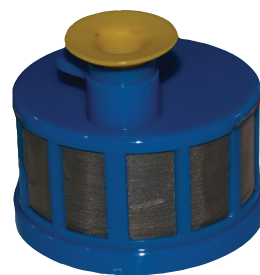

65L-13915-00-00  
S225 / S250 (97~98)  
V200 / V225 (97~98)



68F-13915-00-00  
Z150 / Z175 / Z200  
VZ150 / VZ175 / VZ200  
VZ225 / VZ250 / VZ300  
Z250 / Z300



68V-13915-00-00  
F115  
F200 / F225 (V6)

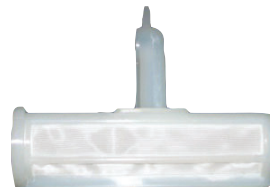

6C5-13915-00-00  
F50/T50 / F60/T60  
F70 / F75 / F90



6FP-13915-00-00  
F75B (17)  
F90B  
VF90



6CB-13915-00-00  
VF200 / VF225 / VF250 (4.2L)  
F225 / F250 / F300 (4.2L)



63P-13915-00-00  
F150 / F200 (2.8L)  
F225 Sport / F250 / F250B  
F300 / F350 (V8)

General Information  
Rigging Estimate Guide (Diagrams)  
Rigging Components  
Electrical Components  
Engine Accessories  
Propellers  
Maintenance Items  
Yamaha & Trailer Supplies  
Accessories & Apparel



## VST Gaskets

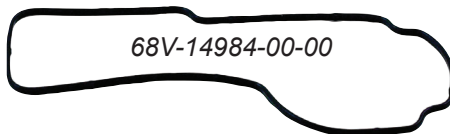
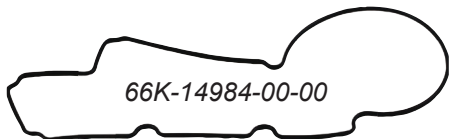
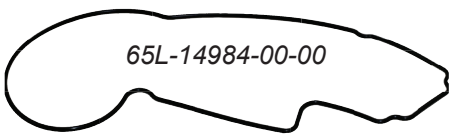
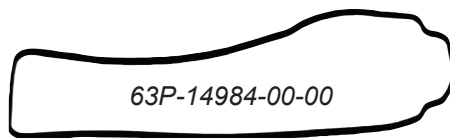
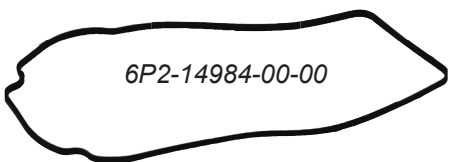
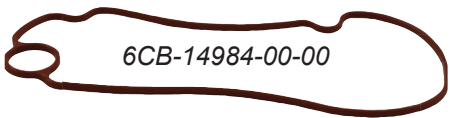
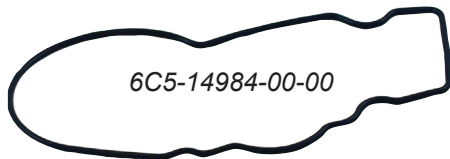
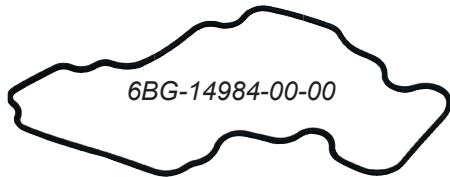
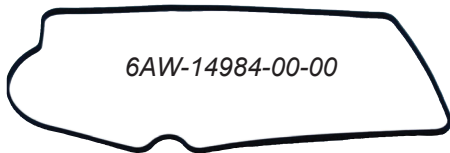

Application	Part Number
F40 EFI	6BG-14984-00-00
F50/T50 / F60/T60	6C5-14984-00-00
F70	6C5-14984-00-00
F75 / F90	6C5-14984-00-00
F115	68V-14984-00-00
F90B	6FP-14984-00-00
VF90	6FP-14984-00-00
F150	63P-14984-00-00
SX150 / SX200 / SX225 / SX250	66K-14984-00-00
DX150 / PX150	66K-14984-00-00
VX150 / VX200 / VX225 / VX250	66K-14984-00-00
Z150 / Z175 / Z200 / Z250 / Z300	66K-14984-00-00
VZ150, VZ175, VZ200	66K-14984-00-00
F175	6CB-14984-00-00
V200 / V225 (97~98)	65L-14984-00-00
V200 / V25 (99~)	66K-14984-00-00
F200 / F225 (V6)	68V-14984-00-00
VZ225 / VZ250 / VZ300	66K-14984-00-00
VF200 / VF225 / VF250 (4.2L)	6CB-14984-00-00
F225 / F250 / F300 (4.2L)	6CB-14984-00-00
S225 / S250 (97~98)	65L-14984-00-00
S225 / S250 (99~)	66K-14984-00-00
F225 Sport	6P2-14984-00-00
F250 / F250B	6P2-14984-00-00
F350 (V6)	6CB-14984-00-00
F300 / F350 (V8)	6AW-14984-00-00
XTO® 425 / 450	6GR-24218-00-00

## Engine Timing Belts

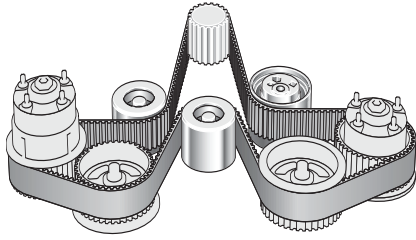

Application	Part Number
F6 (05-06/2008)	68T-46241-00-00
F6 / F8 / T8 (01-04)	68T-46241-00-00
F8 / T8 (05~)	68T-46241-00-00
F9.9 / FT9.9 (85-04/2005)	6G8-46241-00-00
T9.9 (91-04/2005)	6G8-46241-00-00
F9.9-2 / T9.9-2 (05-04/2006)	66M-46241-00-00
F9.9F / T9.9F (04/2007~)	68T-46241-00-00
F15 (98-04/2005)	66M-46241-00-00
F15C / F20	6AH-46241-00-00
F25 / T25 (98-04/2006)	65W-46241-00-00
F25 / T25 (04/2009~)	6C5-46241-00-00
F25C / T25C	6FM-46241-00-00
F30	65W-46241-00-00
F40 (99)	62Y-46241-00-00
F40 (00-04/2008)	65W-46241-00-00
F40LA	6C5-46241-00-00
F50 / T60 (96-04)	62Y-46241-00-00
F60 / T60 (02-04)	62Y-46241-00-00
F50 / T50 / F60 / T60 / F70 (05~)	6C5-46241-00-00
F75 / F90	67F-46241-00-00
F90B	6FP-W4624-00-00
VF90	6FP-W4624-00-00
F80 / F100	67F-46241-00-00
F115	67F-46241-00-00
F115	6EK-W4624-00-00
F150	63P-46241-00-00
F200 / F225	69J-46241-00-00
VF200 / VF225 / VF250 (4.2L)	6CB-W4624-00-00
F225 / F250 / F300 (4.2L)	6CB-W4624-00-00
F225 Sport / F250 / F250B	6P2-46241-02-00
F300 / F350 (V8)	6AW-W4624-00-00
F350 (V6)	6CB-W4624-00-00
2.6L HPDI (04~)	68F-46241-10-00
2.6L HPDI (~03)	68F-46241-00-00
3.3L HPDI	60V-46241-00-00
XTO® 425 / 450	6GR-W4624-00-00

General Information

Rigging Estimate Guide (Diagrams)

Rigging Components

Electrical Components

Engine Accessories

Propellers

Maintenance Items

Yamaha & Trailer Supplies

Accessories & Apparel

## Trim Tabs

2-Stroke Application	Part Number
20 / 25 / C25 / 30 / 40 / 50	664-45371-01-00
CV25 / CV30 / C40 (97~) / C50	664-45371-01-00
C40 (~96) / CV40 / E48 / C55 / CV55	679-45371-00-00
P40 / P50 / PRO 50	664-45371-01-00
60 / 70 / 90 / E60 / P60 / E75 / P75 / B90	67F-45371-00-00
C60 / C70 / C75 / C80 / C85 / CV85 / C90	67F-45371-00-00
60~130 High Performance Propeller	6E5-45371-01-00
C150 (96~99) / 150 / 175 / S175 / V175	6J9-45371-01-00
P150 / PX150 / ProV150 / P175	6J9-45371-01-00
S150 / SX150 / V150 / VX150	6J9-45371-01-00
Z150 / Z175 / Z200 (2.6L)	6J9-45371-01-00
200 / P200 / S200 / SX200	6J9-45371-01-00
VZ200 / VZ225 / VZ250 / VZ300 (3.3L)	69L-45371-00-00
225, / S225 / SX225 / 250 / S250v SX250	6CE-45373-00-00
V200 / VX200 / V225 / VX225	6CE-45373-00-00
Z250 / Z300	69L-45371-00-00
L130 (~01)	6L6-45371-00-00
L225 / LX225 / L250 / LX250 (92~03)	6CE-45373-00-00
L150 / LX150, / L200 / LX200 (~01)	6K1-45371-02-00
LZ150 / LZ200	6K1-45371-02-00

4-Stroke Application	Part Number
F9.9G / F15	66M-45371-00-00
F15C / F20	6AH-45371-A0-00
F25 (98~)	61N-45371-00-00
F25C / T25C	664-45371-01-00
T25 / F30 / F40 (00~)	67C-45371-00-00
F40 / F50 (95~00)	664-45371-01-00
F50 / F60 (01~)	67C-45371-00-00
T50 (96~00)	67F-45371-00-00
T50 (96~97)	664-45371-01-00
T50 / T60 (01~)	67F-45371-00-00
F70 / F75 / F80 / F90 / F100	67F-45371-00-00
F90B / VF90 / F115	6E5-45371-01-00
F150	6J9-45371-01-00
F200 / F225 / F225 Sport / F250 / F250B	6CE-45373-00-00
VF200 / VF225 / VF250	6AW-45619-00-00
F225 / F250 / F300 (4.2L)	6CE-45373-00-00
F300 / F350 (V8)	6AW-45619-00-00
F350 (V6)	6CE-45373-00-00
LF115	6L6-45371-00-00
LF150	6K1-45371-00-00
Stern drives	6T5-45371-00-00



6AH-45371-A0-00



66M-45371-00-00



61N-45371-00-00



6L6-45371-00-00



679-45371-00-00



67C-45371-00-00



67F-45371-00-00



6K1-45371-02-00



6E5-45371-01-00



6AW-45619-00-00



69L-45371-00-00



6E5-45371-10-00



664-45371-01-00



6CE-45373-00-00



67F-45371-00-00



6J9-45371-01-00

## Anodes

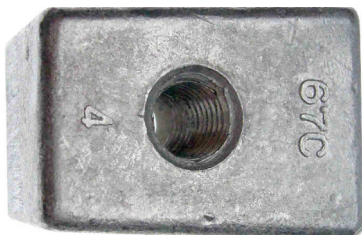
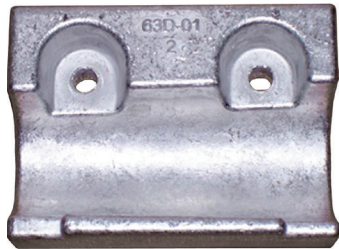
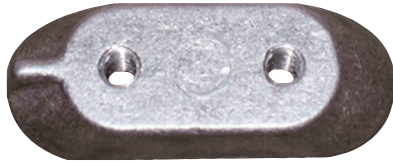

2-Stroke Application	Part Number
6 (90~93)	6GH-45251-00-00
9.9 / 15 (95~02)	61N-45251-01-00
C30 (93~97)	61N-45251-01-00
40 / C40 / 50	63D-45251-01-00
40 / C40 / 50 (01~)	65W-45251-00-00
C55 (91~95)	663-45251-00-00
CV55 (88~89)	663-45251-00-00
50 (00)	663-45251-00-00
C55 / C60 / C70 / C75 / C80 / C85 / C90	6H1-45251-03-00
60 / 70 / 90 (00~)	6H1-45251-03-00
E60 / E75	6H1-45251-03-00
2 Stroke V4 & V6 ALL	6G5-45251-02-00

4-Stroke Application	Part Number
F6 (04/05~06/08)	68T-45251-00-00
T8 (01~)	65W-45251-00-00
F9.9 (98~)	6E8-45251-02-00
T9.9G	65W-45251-00-00
F15 (01~)	65W-45251-00-00
F15C / F20	65W-45251-00-00
F25 / T25 (99~)	65W-45251-00-00
F25C / T25C	
F30 / F40 (00~)	65W-45251-00-00
F50 / T50 / F60 / T60 (01~)	65W-45251-00-00
F70	65W-45251-00-00
F75 / F80 / F90 / VF90 / F100	6H1-45251-03-00
F115 / F150 / F200 / F225	6G5-45251-02-00
VF200 / VF225 / VF250	65W-45251-00-00
F225 Sport / F250 / F250B	6G5-45251-02-00
F225 / F250 / F300 (4.2L)	6G5-45251-02-00
F350 (V6)	6G5-45251-02-00
F300 / F350 (V8)	6AW-45251-00-00
XTO® 425 / 450	6AW-45373-00-00

## Anode Kits

Part Number	Part Description	Compatible Models
90798-1M680-00	ANODE KIT F300	4.2L Offshore Models (No Bracket Anode)
90798-1M681-00	ANODE KIT F200	2.8L F150, F175, F200 Models
90798-1M682-00	ANODE KIT F150	2.7L F150 Models
90798-1M683-00	ANODE KIT F115	All F115 / VF115 Models

General Information

Rigging Estimate Guide (Diagrams)

Rigging Components

Electrical Components

Engine Accessories

Propellers

Maintenance Items

Yamaha & Trailer Supplies

Accessories & Apparel

## Thermostats



### 2-Stroke Application Part Number

3 / 4 / 5 / 6 / 8	6E5-12411-02-00
9.9 / 15 (~95)	6F5-12411-03-00
9.9 / 15 (96~)	6E5-12411-30-00
20 / 40 / 50, / C50 / P50	6E5-12411-30-00
25 Three Cylinder	6E5-12411-30-00
25 Two Cylinder	6E5-12411-30-00
C25	6F5-12411-03-00
30 (~91)	6E5-12411-30-00
30 (92~)	6E5-12411-30-00
C30 (~92)	6F5-12411-03-00
C30 (93~)	6E5-12411-02-00
40 / 50	6E5-12411-30-00
C40 / C55 (~97)	6F5-12411-03-00
C40 (98~)	6E5-12411-30-00
60 / C60 / E60 / P60 / 70 / C70	6H3-12411-11-00
C75 / P75 / E75 / C80 / C85 / 90 / C90	6E5-12411-30-00
115 / 130 / 150 / 175 / 200 / 225 / 250	6E5-12411-30-00
B115 / C115 / C150v D150 / DX150	6E5-12411-30-00
P115 / P150 / PX150 / P200	6E5-12411-30-00
S115 / S130 / SX150 / SX200	6E5-12411-30-00
S225 / SX225v S250v SX250	6E5-12411-30-00
V150 / VX150v V200v VX200	6E5-12411-30-00
VX225 / VX250	6E5-12411-30-00
VZ150 / VZ175 / VZ200 (2.6L)	6E5-12411-30-00
Z150 / Z175 / Z200 (2.6L)	6E5-12411-30-00
VZ200 / VZ225 / VZ250v VZ300 (3.3L)	60V-12411-00-00
Z250, Z300 (3.3L)	60V-12411-00-00

### 4-Stroke Application Part Number

F2.5 / F4 / F4A / F6 / F6A / F8 / T8	66M-12411-01-00
F9.9 / T9.9 / F15 / F25 / T25	66M-12411-01-00
F15C-F20	6AH-12411-00-00
F30 / F40 / F40A / F50 / T50	66M-12411-01-00
F25C / T25C	6FM-12411-00-00
F60 / T60 / F70	66M-12411-01-00
F75 / F90	67F-12411-01-00
F90B	6FP-12411-00-00
VF90	6FP-12411-00-00
F80 / F100 (~00)	66M-12411-01-00
F80 / F100 (01~)	67F-12411-01-00
F115	60V-12411-00-00
F115B	6EK-12411-00-00
F150 / F200 / F225 / F250 / F250B	67f-12411-01-00
~2010 VF200 / VF225 / VF250 (4.2L)	67F-12411-01-00
2011~ VF200 / VF225 / VF250	6CB-12411-10-00
F225 / F250 / F300 (4.2L)	6CE-12411-00-00
F350 (V6)	6CE-12411-10-00
F300 / F350 (V8)	6AW-12411-00-00
XTO® 425 / 450	6GR-12411-00-00

## Thermostat Gaskets



Application	Part Number
F2.5 (03~)	67D-12414-A0-00
F4 (99~)	67D-12414-A0-00
F4A, F6A	67D-12414-A0-00
F6 / F8 / T8 / F9.9 / FT9.9 / T9.9	6G8-12414-A0-00
9.9 / 15	682-12414-A1-00
F9.9-2 / T9.9-2	62Y-12414-01-00
F15 / F25 / T25 / F30	62Y-12414-01-00
F15C / F20	6AH-12414-00-00
20	61A-12414-A0-00
25 / 30 / 40	61A-12414-A0-00
F25C / T25C	6FM-12414-00-00
C25 / CV25 / C30 / CV30	655-12414-A1-00
C40 / CV40 (~97)	6E9-12414-A1-00
C40 / C50 (98~)	61A-12414-A0-00
P40	61A-12414-A0-00
F40 / F50, / T50 / F60 / T60 / F70	62Y-12414-01-00
C55 / E48	663-12414-A0-00
C75 / E75 / P75 / C80 / C80	688-12414-A1-00
C85 / CV85 / C90	688-12414-A1-00
90 / B90 / B115	688-12414-A1-00
115 / 130 / 150 / 175 / 200	688-12414-A1-00
P115 / P150 / PX150v P175 / P200	688-12414-A1-00
S115 / S130 / S150 / S175 / S200	688-12414-A1-00
D150 / DX150	688-12414-A1-00
F150	63P-12414-00-00
SX150, SX200, V150, VX150, V175	688-12414-A1-00
ProV150	688-12414-A1-00
VZ150 / VZ175 / VZ200 (2.6L)	688-12414-A1-00
Z150 / Z175 / Z200 (2.6L)	688-12414-A1-00
V200 / V225	61A-12414-A0-00
VX200 / VX225 / VX250	61A-12414-A0-00
VZ200 / VZ225 / VZ250 / VZ300 (3.3L)	60V-12414-A0-00
Z250 / Z300	60V-12414-A0-00
225 (2.6L)	688-12414-A1-00
225 / 250 / S225 / S250 / SX225 / SX250	61A-12414-A0-00

General Information

Rigging Estimate Guide (Diagrams)

Rigging Components

Electrical Components

Engine Accessories

Propellers

Maintenance Items

Yamaha & Trailer Supplies

Accessories & Apparel

# Maintenance Items

General Information

Rigging Estimate Guide (Diagrams)

Rigging Components

Electrical Components

Engine Accessories

Propellers

Maintenance Items

Yamalube & Trailer Supplies

Accessories & Apparel

## 4-Stroke Carburetor Repair Kits

### F2.5

**69M-W0093-00-00**

Kit Includes:

Qty	Description	Part #
1	Gasket, Float Chamber	69M-14984-00-00
1	Float	69M-14385-00-00
1	Pin, Float	6A1-14386-00-00
1	Screw, Pan Head	98580-03006-00
1	Valve, Needle	62Y-14392-00-00
1	Screw	69M-14991-00-00

Qty	Description	Part #
2	Screw, Pan Head	98580-04010-00
1	O-Ring	2T4-14397-01-00
1	Gasket	69M-14536-00-00
1	Valve	69M-24523-00-00
1	O-Ring	69M-24533-00-00
1	Screw, Lever Fitting	69M-24535-00-00

### F4 / F6 (09/2009~)

**6BX-W0093-00-00**

Kit Includes:

Qty	Description	Part #
1	Float	6BX-14985-00-00
1	Gasket, Float Chamber	6BX-14984-00-00
2	Screw	6BX-14592-00-00
2	O-Ring	67F-14398-10-000

Qty	Description	Part #
1	Valve, Needle	6BX-14546-00-00
1	Pin, Float Arm	6BX-14548-00-00
1	Clip	6BX-14937-00-00

### F4 (03~06/2008)

**67D-W0093-01-00**

Kit Includes:

Qty	Description	Part #
1	Float	68T-14385-00-00
1	Pin, Float	67D-14386-00-00
1	Valve, Needle	67D-14546-00-00
1	Gasket, Float Chamber	67D-14984-00-00

Qty	Description	Part #
1	Gasket	6J8-14995-00-00
2	Screw, With Washer	97980-04112-00
1	Gasket	67D-14536-00-00

### F4 (~-02)

**67D-W0093-00-00**

Kit Includes:

Qty	Description	Part #
1	Float	67D-14385-00-00
1	Pin, Float	67D-14386-00-00
1	Valve, Needle	67D-14546-00-00
1	Gasket, Float	67D-14984-00-00

Qty	Description	Part #
1	Gasket	6J8-14995-00-00
2	Screw, With Washer	97980-04112-00
1	Gasket	67D-14536-00-00

### F6 (04/2007~06/2008)

**F8 / T8 / F9.9 / T9.9 (04/2007~)**

**6AU-W0093-00-00**

Kit Includes:

Qty	Description	Part #
2	Screw, With Washer	97980-04112-00
1	Float	6AU-14385-00-00
1	Pin, Float	67D-14386-00-00
1	Valve, Needle	68T-14546-00-00

Qty	Description	Part #
1	Gasket, Float Chamber	6AU-14984-00-00
1	Gasket	6J8-14995-00-00
1	Gasket	67D-14536-00-00

### F6 / F8 / T8 (~04/2006)

**68T-W0093-00-00**

Kit Includes:

Qty	Description	Part #
1	Float	68T-14385-00-00
1	Pin, Float	67D-14386-00-00
1	Valve, Needle	68T-14546-00-00
1	Gasket, Float Chamber	67D-14984-00-00

Qty	Description	Part #
1	Gasket	6J8-14995-00-00
2	Screw, With Washer	97980-04112-00
1	Gasket	67D-14536-00-00

\*Each carburetor kit will rebuild all carburetors on one motor.

## 4-Stroke Carburetor Repair Kits

### FT9.9

**6G8-W0093-02-00**

Kit Includes:

Qty	Description	Part #	Qty	Description	Part #
1	Gasket	6G8-14198-A0-00	1	Float	6G8-14385-00-00
1	Gasket, Float Chamber	6G8-14384-00-00	1	Screw, Panhead	98580-04016-00
1	Pin, Float	647-14386-10-00	1	Washer, Spring	92990-04100-00
1	Gasket	654-14198-00-00	2	O-Ring	1J2-14397-00-00
1	Screw, Air Adjusting	6G8-14323-00-00	1	O-Ring	5H0-14397-00-00
1	Valve, Needle	6G8-14392-00-00	1	O-Ring	5Y1-14397-00-00

### F9.9 / T9.9 (~04/2005)

**6G8-W0093-03-00**

Kit Includes:

Qty	Description	Part #	Qty	Description	Part #
1	Gasket	6G8-14198-A0-00	1	Valve, Needle	6G8-14392-00-00
1	Gasket, Float Chamber	6G8-14384-01-00	1	Float	6G8-14385-00-00
1	Pin, Float	647-14386-10-00	1	Screw, Panhead (+)	98580-04016-00
1	Gasket	654-14198-00-00	1	Washer, Spring	92990-04100-00
1	Screw, Air Adjusting	6G8-14323-00-00	1	O-Ring	5Y1-14397-00-00

### F9.9-2 / T9.9-2 F15 (~04/2005)

**66M-W0093-01-00**

Kit Includes:

Qty	Description	Part #	Qty	Description	Part #
1	Gasket	66M-14398-00-00	1	Gasket	62Y-14399-00-00
1	Gasket	6L2-14398-00-00	1	Screw, Air Adjusting	12V-14105-00-00
1	Stopper	66M-14377-00-00	4	Screw, With Washer	97980-04112-00
1	Gasket, Float Chamber	66M-14384-00-00	1	O-Ring	5H0-14397-00-00
1	Float	6L2-14385-00-00	1	O-Ring	6F5-14397-00-00
1	Pin, Float	6E5-14386-01-00	1	Filter	66M-14827-00-00
1	Valve, Needle	6L2-14392-00-00			

### F15C / F20 (04/2006~04/2009)

**6AH-W0093-00-00**

Kit Includes:

Qty	Description	Part #	Qty	Description	Part #
1	Gasket	65W-14126-10-00	1	Gasket, Float Chamber	6AH-14384-00-00
1	Valve, Needle	6AH-14546-00-00	1	Gasket	6G1-14398-00-00
1	Pin, Float	676-14186-00-00	4	Screw, With Washer	97980-04114-00
1	Pin, Float Arm	6H4-14548-00-00	1	Float	6AH-14985-00-00
1	Cover, Plunger Cap	65W-14373-01-00	1	Clip	633-14159-00-00
1	O-Ring	67F-14398-10-00			

### F15C / F20 (04/2010~)

**6AH-W0093-02-00**

Kit Includes:

Qty	Description	Part #	Qty	Description	Part #
1	Gasket	65W-14126-10-00	1	Gasket, Float Chamber	6AH-14384-00-00
1	Valve, Needle	6AH-14546-00-00	1	Gasket	6G1-14398-00-00
1	Pin, Float Arm	6H4-14548-00-00	4	Screw, With Washer	97980-04114-00
1	Cover, Plunger Cap	65W-14373-02-00	1	Float	6AH-14985-00-00
1	O-Ring	67F-14398-10-00	1	Clip	633-14159-00-00

\*Each carburetor kit will rebuild all carburetors on one motor.



# Maintenance Items

General Information

Rigging Estimate Guide (Diagrams)

Rigging Components

Electrical Components

Engine Accessories

Propellers

**Maintenance Items**

Yamalube & Trailer Supplies

Accessories & Apparel

## 4-Stroke Carburetor Repair Kits

**F25 / T25 (~03)**

**65W-W0093-00-00**

Kit Includes:

Qty	Description	Part #
1	Gasket	65W-14126-00-00
1	Valve, Needle	6AH-14546-00-00
1	Pin, Float	676-14186-00-00
1	Pin, Float Arm	6H4-14548-00-00
1	Cover, Plunger Cap	65W-14373-01-00
1	O-Ring	65W-14147-00-00

Qty	Description	Part #
1	Spring, Plunger	65W-14335-00-00
1	Gasket, Float Chamber	65W-14384-00-00
1	Gasket	6G1-14398-00-00
4	Screw, With Washer	97980-04114-00
1	Float	63V-14985-00-00
1	Clip	633-14159-00-00

**F25 / T25 (04/2009~)**

**6BL-W0093-00-00**

Kit Includes:

Qty	Description	Part #
1	Gasket	65W-14126-10-00
1	Valve, Needle	6AH-14546-00-00
1	Pin, Float Arm	6H4-14548-00-00
1	Cover, Plunger Cap	65W-14373-02-00
1	O-Ring	67F-14398-10-00
1	Spring, Plunger	65W-14335-00-00

Qty	Description	Part #
1	Gasket, Float Chamber	65W-14384-00-00
1	Gasket	6G1-14398-00-00
4	Screw, With Washer	97980-04114-00
1	Float	63V-14985-00-00
1	Clip	633-14159-00-00

**F25 / T25(04~04/2006)**

**F30 / F40 / F40B (00~)**

**65W-W0093-02-00**

Kit Includes:

Qty	Description	Part #
1	Gasket	65W-14126-10-00
1	Valve, Needle	6AH-14546-00-00
1	Pin, Float	676-14186-00-00
1	Pin, Float Arm	6H4-14548-00-00
1	Cover, Plunger Cap	65W-14373-02-00
1	O-Ring	67F-14398-10-00

Qty	Description	Part #
1	Spring, Plunger	65W-14335-00-00
1	Gasket, Float Chamber	65W-14384-00-00
1	Gasket	6G1-14398-00-00
4	Screw, With Washer	97980-04114-00
1	Float	63V-14985-00-00
1	Clip	633-14159-00-00

**F40 (99) / F50 (~00)**

**62Y-W0093-00-00**

Kit Includes:

Qty	Description	Part #
1	Gasket, Float Chamber	6L2-14384-01-00
1	Float	6L2-14385-00-00
1	Pin, Float	6E5-14386-01-00
1	Valve, Needle	6L2-14392-00-00
1	Gasket	62Y-14399-00-00
1	Plug	62Y-14355-00-00
1	Screw, Air Adjusting	12V-14105-00-00

Qty	Description	Part #
4	Screw, With Washer	97980-04112-00
1	O-Ring	5H0-14397-00-00
1	Gasket	62Y-14398-30-00
1	O-Ring	6F5-14397-00-00
4	O-Ring	93210-35M86-00
4	O-Ring	93210-35M86-00

**F50 (01~)**

**62Y-W0093-11-00**

Kit Includes:

Qty	Description	Part #
1	Gasket, Float Chamber	62Y-14384-31-00
1	Float	6L2-14385-00-00
1	Pin, Float	6E5-14386-01-00
1	Valve, Needle	6L2-14392-00-00
8	Screw, Throttle	62Y-14321-00-00
1	Gasket	62Y-14399-31-00
1	Plug	62Y-14355-30-00

Qty	Description	Part #
1	Screw, Air Adjusting	62Y-14323-30-00
1	O-Ring	2T4-14397-01-00
1	O-Ring	652-14397-00-00
1	Gasket	62Y-14398-30-00
4	O-Ring	93210-30MH4-00
4	O-Ring	93210-35M86-00
1	Washer	62Y-14227-01-00

\*Each carburetor kit will rebuild all carburetors on one motor.

## 4-Stroke Carburetor Repair Kits

### F60

**69W-W0093-10-00**

Kit Includes:

Qty	Description	Part #	Qty	Description	Part #
1	Gasket, Float Chamber	69W-14384-00-00	1	O-Ring	2T4-14397-01-00
1	Float	6L2-14385-00-00	1	O-Ring	652-14397-00-00
1	Pin, Float	6E5-14386-01-00	1	Gasket	62Y-14398-30-00
1	Valve, Needle	6L2-14392-00-00	4	O-Ring	69W-14561-00-00
8	Screw, Throttle	62Y-14321-00-00	4	O-Ring	93210-35M86-00
1	Gasket	69W-14399-00-00	4	O-Ring	93210-38MH3-00
1	Screw, Air Adjusting	69W-14323-00-00	4	Washer	62Y-14227-01-00

### F75 / F90

**F80/F100 (03~)**

**67F-W0093-03-00**

Kit Includes:

Qty	Description	Part #	Qty	Description	Part #
1	O-Ring	67F-14147-00-00	1	Needle Valve Assy	60C-14590-03-00
4	Screw, With Washer	97980-04114-00	1	O-Ring	93210-04228-00
1	O-Ring	67F-14397-00-00	1	O-Ring	67F-14398-00-00
1	Gasket, Float Chamber	67F-14984-00-00	1	O-Ring	67F-14398-10-00
1	O-Ring	93210-04230-00	1	O-Ring	67F-14398-20-00
1	Float	6H4-14985-01-00	1	Seal	67F-14239-00-00
1	Pin, Float	676-14186-00-00	1	Element, Filter	67F-14371-01-00
1	Clip	67F-14159-00-00	2	O-Ring	93210-40M10-00
1	Pin, Float Arm	6H4-14548-00-00	1	O-Ring	67F-14398-30-00

### F80 / F100 (~02)

**67F-W0093-00-00**

Kit Includes:

Qty	Description	Part #	Qty	Description	Part #
1	O-Ring	67F-14147-00-00	1	Needle Valve Assy	6H3-14590-02-00
4	Screw, With Washer	97980-04114-00	1	O-Ring	93210-04228-00
1	O-Ring	67F-14397-00-00	1	O-Ring	67F-14398-00-00
1	Gasket, Float Chamber	67F-14984-00-00	2	O-Ring	67F-14398-10-00
1	O-Ring	93210-04230-00	1	O-Ring	67F-14398-20-00
1	Float	6H4-14985-01-00	1	Seal	67F-14239-00-00
1	Pin, Float	676-14186-00-00	1	Element, Filter	67F-14371-01-00
1	Clip	633-14159-00-00	2	O-Ring	93210-40M10-00
1	Pin, Float Arm	6H4-14548-00-00	1	O-Ring	67F-14398-30-00

\*Each carburetor kit will rebuild all carburetors on one motor.

# Maintenance Items

General Information

Rigging Estimate Guide (Diagrams)

Rigging Components

Electrical Components

Engine Accessories

Propellers

Maintenance Items

Yamalube & Trailer Supplies

Accessories & Apparel

## 2-Stroke Carburetor Repair Kits

### 2 (90~93)

Part List (not sold as a kit):

Qty	Description	Part #
1	Gasket, Float Chamber	6A1-14384-00-00
1	Float	6A1-14385-00-00
1	Pin, Float	6A1-14386-00-00
2	Screw, Panhead	98580-04010-00
1	Valve, Needle	6A1-14392-00-00

Qty	Description	Part #
1	Screw, Pilot Adjusting	646-14211-02-00
1	Needle	6A1-14116-10-00
1	Clip	646-14137-00-00
1	O-Ring	646-14229-01-00
1	Gasket	6A1-14398-00-00

### 2 (94~)

#### 6A1-W0093-03-00

Kit Includes:

Qty	Description	Part #
1	Gasket, Float Chamber	6A1-14384-00-00
1	Float	6A1-14385-00-00
1	Pin, Float	6A1-14386-00-00
2	Screw, With Washer	97980-04110-00
1	Valve, Needle	6A1-14392-00-00

Qty	Description	Part #
1	Screw, Pilot Adjusting	646-14211-02-00
1	Needle	6A1-14116-10-00
1	Clip	646-14137-00-00
1	O-Ring	646-14229-01-00
1	Gasket	646-14198-01-00

### 3 / 6 / 8 (90~96)

#### 6G1-W0093-01-00

Kit Includes:

Qty	Description	Part #
1	Screw, Pilot	679-14923-01-00
1	Cap	6G1-14966-00-00
1	Gasket	6G1-14126-00-00
1	Cap	679-14966-00-00
1	O-Ring	6G1-14984-00-00

Qty	Description	Part #
4	Screw, With Washer	97980-04114-00
1	Float	6G1-14985-00-00
1	Valve, Needle	6G1-14546-00-00
1	Pin, Float	676-14186-00-00
1	Pin, Float Arm	688-14548-00-00

### 4 (90~94)

#### 6E0-W0093-02-00

Kit Includes:

Qty	Description	Part #
1	Gasket	6E0-14198-A0-00
1	Gasket, Float Chamber	6E0-14384-00-00
1	Screw, Panhead	98580-04016-00
1	Gasket	6A1-14398-00-00
1	Float	6E7-14385-00-00
1	Pin, Float	647-14386-10-00

Qty	Description	Part #
1	Valve, Needle	6G8-14392-10-00
1	Gasket	6E0-14227-00-00
1	Screw, Air Adjusting	647-14323-00-00
1	Diaphragm	6E0-24471-00-00
1	Diaphragm	6E0-24411-00-00

### 4 / 5 (95~96)

#### 6E0-W0093-03-00

Kit Includes:

Qty	Description	Part #
1	Gasket	6E0-14198-A0-00
1	Gasket, Float Chamber	6E0-14384-00-00
1	Screw, Panhead	98580-04016-00
1	Gasket	6A1-14398-00-00
1	Float	6E7-14385-01-00
1	Pin, Float	647-14386-10-00

Qty	Description	Part #
1	Valve, Needle	6F5-14392-00-00
1	Gasket	6E0-14227-00-00
1	Screw, Air Adjusting	647-14323-00-00
1	Diaphragm	6E0-24471-00-00
1	Diaphragm	6E0-24411-00-00

### 4 (97~)

#### 6E0-W0093-04-00

Kit Includes:

Qty	Description	Part #
1	Gasket	6E0-14198-A0-00
1	Gasket, Float Chamber	6E0-14384-00-00
4	Screw, With Washer	98580-04016-00
1	Gasket	646-14198-01-00
1	Float	6E7-14385-01-00
1	Pin, Float	647-14386-10-00

Qty	Description	Part #
1	Valve, Needle	6F5-14392-00-00
1	Gasket	6E0-14227-00-00
1	Screw, Air Adjusting	647-14323-00-00
1	Diaphragm	6E0-24471-00-00
1	Diaphragm	6E0-24411-00-00

\*Each carburetor kit will rebuild all carburetors on one motor.

## 2-Stroke Carburetor Repair Kits

6 / 8 (97~)

**6G1-W0093-01-00**

Kit Includes:

Qty	Description	Part #	Qty	Description	Part #
1	Screw, Pilot	679-14923-01-00	4	Screw, With Washer	97980-04114-00
1	Cap	6G1-14966-00-00	1	Float	6G1-14985-00-00
1	Gasket	6G1-14126-00-00	1	Valve, Needle	6G1-14546-01-00
1	Cap	679-14966-00-00	1	Pin, Float	676-14186-00-00
1	O-Ring	6G1-14984-00-00	1	Pin, Float Arm	688-14548-00-00

9.9 (90~95)

15 (90~92)

**6E7-W0093-04-00**

Kit Includes:

Qty	Description	Part #	Qty	Description	Part #
1	Gasket	677-14198-A1-00	1	Gasket, Float Chamber	677-14384-01-00
1	Needle Valve Assy	6E8-14390-12-00	1	Gasket	1J2-14398-00-00
1	Gasket	367-14195-00-00	1	Gasket	655-14398-00-00
1	Float	6E7-14385-00-00	1	Screw, Air Adjusting	647-14323-00-00
1	Pin, Float	647-14386-10-00	1	Gasket	6E7-14227-00-00

9.9 / 15 (96~)

**63V-W0093-01-00**

Kit Includes:

Qty	Description	Part #	Qty	Description	Part #
1	Screw, Pilot	679-14923-01-00	1	Float	63V-14985-00-00
1	Gasket	63V-14126-00-00	1	Valve, Needle	6AH-14546-00-00
1	Gasket, Float Chamber	63V-14984-00-00	1	Pin, Float	676-14186-00-00
4	Screw, With Washer	97980-04114-00	1	Clip	633-14159-00-00
1	Gasket	6G1-14398-00-00	1	Pin, Float Arm	6H4-14548-00-00

15 (93~95)

Part List (not sold as a kit):

Qty	Description	Part #	Qty	Description	Part #
1	Needle Valve Assy	61J-14390-00-00	1	Gasket	1J2-14398-00-00
1	Gasket	367-14195-00-00	1	Gasket	655-14398-00-00
1	Float	6E7-14385-00-00	1	Screw, Air Adjusting	647-14323-00-00
1	Pin, Float	647-14386-10-00	1	Gasket	6E7-14227-00-00
1	Gasket, Float Chamber	677-14384-01-00			

20 / 25 Two Cyl

**6L2-W0093-00-00**

Kit Includes:

Qty	Description	Part #	Qty	Description	Part #
2	Gasket	6L2-14198-00-00	2	Valve, Needle	6L2-14392-00-00
2	Gasket, Float Chamber	6L2-14384-01-00	2	Gasket	6L2-14399-01-00
2	Float	6L2-14385-00-00	2	Screw, With Washer	97980-04112-00
2	Pin, Float	6E5-14386-01-00	2	Gasket	6L2-14398-00-00

25 (84~87)

**C25 (91~97) / CV25 (90)**

**30 (84~86) / C30 (91~92)**

**CV30 (89~90)**

**689-W0093-02-00**

Kit Includes:

Qty	Description	Part #	Qty	Description	Part #
1	Gasket	648-14198-A0-00	1	Needle Valve Assy	61K-14390-00-00
1	Gasket, Float Chamber	648-14384-01-00	1	Screw, Air Adjusting	647-14323-00-00
1	Float	648-14385-00-00	2	Bush	90386-05002-00
4	Screw, With Washer	98517-04012-00	1	O-Ring	646-14397-00-00
1	Washer, Spring	92990-04100-00			

\*Each carburetor kit will rebuild all carburetors on one motor.

General Information

Rigging Estimate Guide (Diagrams)

Rigging Components

Electrical Components

Engine Accessories

Propellers

Maintenance Items

Yamaha & Trailer Supplies

Accessories & Apparel

# Maintenance Items

General Information

Rigging Estimate Guide (Diagrams)

Rigging Components

Electrical Components

Engine Accessories

Propellers

**Maintenance Items**

Yamalube & Trailer Supplies

Accessories & Apparel

## 2-Stroke Carburetor Repair Kits

**25 Three cyl (97~02)**  
**30 / C30 Three cyl (95)**  
**6J8-W0093-00-00**

Kit Includes:

Qty	Description	Part #
3	Gasket	6J8-14198-00-00
3	Gasket, Float Chamber	6J8-14984-00-00
3	Gasket	6J8-14995-00-00
3	Float	6J8-14985-00-00
3	Valve, Needle	6E5-14546-00-00
3	Clip	6J8-14159-00-00

Qty	Description	Part #
3	Pin, Float Arm	6J8-14548-00-00
3	Plug	6J8-14966-00-00
3	Plug	6J8-14126-00-00
3	Plug	6J8-14118-00-00
3	Screw, With Washer	97980-04112-00

**C30 two cyl (94~96)**  
**61N-W0093-00-00**

Kit Includes:

Qty	Description	Part #
1	Valve, Needle	62Y-14392-00-00
1	Pin, Float	6E5-14386-01-00
1	Float	6L2-14385-00-00
1	Gasket	6L2-14399-01-00
1	Plug	50M-14355-01-00

Qty	Description	Part #
1	Gasket	6L2-14398-00-00
1	Gasket, Float Chamber	6L2-14384-01-00
1	Gasket	61N-14198-01-00
1	O-Ring	93210-40659-00

**CV40 / CV40**  
**Two Cyl (91~93)**  
**6E9-W0093-02-00**

Kit Includes:

Qty	Description	Part #
1	Gasket	6E9-14198-A0-00
2	Screw, With Washer	97980-04114-00
2	Needle Valve Assy	6H3-14590-02-00
2	Gasket, Float Chamber	676-14984-00-00
2	Pin, Float Arm	688-14548-00-00
2	Pin, Float	676-14186-00-00

Qty	Description	Part #
2	Clip	633-14159-00-00
2	Float	676-14985-01-00
2	Screw, Pilot	692-14923-00-00
2	O-Ring	93210-04228-00
2	O-Ring	93210-04230-00
4	Gasket	688-14126-00-00

**C40 two Cyl (94~97)**  
**6E9-W0093-03-00**

Kit Includes:

Qty	Description	Part #
1	Gasket	6E9-14198-A0-00
2	Screw, With Washer	97980-04114-00
2	Needle Valve Assy	6H3-14590-02-00
2	Gasket, Float Chamber	676-14984-00-00
2	Pin, Float Arm	688-14548-00-00
2	Pin, Float	676-14186-00-00

Qty	Description	Part #
2	Clip	633-14159-00-00
2	Float	676-14985-01-00
2	Screw, Pilot	692-14923-00-00
2	O-Ring	93210-04228-00
2	O-Ring	93210-04230-00
4	Gasket	688-14126-00-00

**40 / 50 / PRO50 (~88)**  
**6H4-W0093-01-00**

Kit Includes:

Qty	Description	Part #
1	Gasket	6H4-14198-09-00
3	Cap	679-14966-00-00
3	Needle Valve Assy	6H3-14590-02-00
3	Clip	633-14159-00-00
3	Pin, Float	676-14186-00-00
3	Float	6G1-14985-00-00
3	Pin, Float Arm	688-14548-00-00

Qty	Description	Part #
3	O-Ring	6G1-14984-00-00
3	Screw, With Washer	97980-04114-00
3	O-Ring	93210-04230-00
3	Gasket	663-14126-00-00
3	Gasket	688-14126-00-00
3	Screw, Pilot	692-14923-00-00
3	O-Ring	93210-15M52-00

\*Each carburetor kit will rebuild all carburetors on one motor.

## 2-Stroke Carburetor Repair Kits

**40 / 50 / C50**  
**Pro50 (89~)**  
**P40 / P50 / PR50**  
**C40 Three Cyl**  
**6H4-W0093-04-00**

Kit Includes:

Qty	Description	Part #	Qty	Description	Part #
3	Gasket	6H4-14198-01-00	3	Pin, Float Arm	6H4-14548-00-00
3	Cap	679-14966-00-00	3	Gasket, Float Chamber	6H4-14984-00-00
3	Needle Valve Assy	6H4-14590-02-00	3	Screw, With Washer	97980-04114-00
3	Clip	633-14159-00-00	3	O-Ring	93210-04230-00
3	Pin, Float	676-14186-00-00	3	O-Ring	6H4-14147-00-00
3	Float	6H4-14985-01-00	3	Screw, Pilot	692-14923-00-00

**E48 / C55 / CV55**  
**696-W0093-02-00**

Kit Includes:

Qty	Description	Part #	Qty	Description	Part #
1	Gasket	663-14483-A0-00	2	Pin, Float	676-14186-00-00
2	Gasket	663-14198-A0-00	2	Float	6F0-14985-00-00
2	Washer	679-14557-00-00	2	Pin, Float Arm	663-14548-00-00
2	Screw, Pilot	663-14923-00-00	2	O-Ring	93210-64272-00
2	Needle Valve Assy	696-14590-01-00	2	O-Ring	93210-04230-00
2	O-Ring	93210-07229-00	2	Screw w/ Washer	97980-04112-00

**60 (01~04/2005)**  
**P60 (92~99)**  
**70 (92~04/2009)**  
**C70 (00~01)**  
**6H2-W0093-11-00**

Kit Includes:

Qty	Description	Part #	Qty	Description	Part #
1	O-Ring	6H4-14147-00-00	1	Pin, Float	676-14186-00-00
1	O-Ring	93210-04228-00	1	Cap	679-14966-00-00
1	Needle Valve Assy	6H3-14590-02-00	1	Gasket, Float Chamber	6H4-14984-00-00
1	Pin, Float Arm	6H4-14548-00-00	1	O-Ring	93210-04230-00
1	Clip	633-14159-00-00	1	O-Ring	93210-39ME4-00

**P60 (91) / C60 / E60**  
**70 (90~91)**  
**6H3-W0093-03-00**

Kit Includes:

Qty	Description	Part #	Qty	Description	Part #
1	Gasket	6H3-14198-A1-00	3	O-Ring	6G1-14984-00-00
3	Cap	679-14966-00-00	3	Screw, With Washer	97980-04114-00
3	Needle Valve Assy	6H3-14590-02-00	3	O-Ring	93210-04230-00
3	Clip	633-14159-00-00	3	Gasket	663-14126-00-00
3	Pin, Float	676-14186-00-00	3	Gasket	688-14126-00-00
3	Float	6G1-14985-00-00	3	Screw, Pilot	692-14923-00-00
3	Pin, Float Arm	688-14548-00-00	3	O-Ring	93210-15M52-00

**P75 / 90 / C90 (92~)**  
**6H1-W0093-11-00**

Kit Includes:

Qty	Description	Part #	Qty	Description	Part #
1	O-Ring	6H4-14147-00-00	1	Pin, Float	676-14186-00-00
1	O-Ring	93210-04228-00	1	Cap	679-14966-00-00
1	Needle Valve Assy	692-14590-02-00	1	Gasket, Float Chamber	6H4-14984-00-00
1	Pin, Float Arm	6H4-14548-00-00	1	O-Ring	93210-04230-00
1	Clip	633-14159-00-00	1	O-Ring	93210-39ME4-00

**C75 / C80 (98~99)**  
**6H0-W0093-01-00**

Kit Includes:

Qty	Description	Part #	Qty	Description	Part #
1	O-Ring	93210-04228-00	1	Pin, Float Arm	688-14548-00-00
1	Needle Valve Assy	692-14590-02-00	1	Gasket, Float Chamber	676-14984-00-00
1	Clip	633-14159-00-00	1	Cap	679-14966-00-00
1	Pin, Float	676-14186-00-00	1	O-Ring	93210-04230-00

\*Each carburetor kit will rebuild all carburetors on one motor.

General Information

Rigging Estimate Guide (Diagrams)

Rigging Components

Electrical Components

Engine Accessories

Propellers

Maintenance Items

Yamaha & Trailer Supplies

Accessories & Apparel

# Maintenance Items

General Information

Rigging Estimate Guide (Diagrams)

Rigging Components

Electrical Components

Engine Accessories

Propellers

**Maintenance Items**

Yamalube & Trailer Supplies

Accessories & Apparel

## 2-Stroke Carburetor Repair Kits

**C75 / C85 / CV85  
E75 (94~96)  
90 (90~91) / B90  
6H1-W0093-02-00**

Kit Includes:

Qty	Description	Part #
3	Gasket	688-14198-A2-00
3	O-Ring	93210-04228-00
3	Needle Valve Assy	692-14590-02-00
3	Pin, Float	676-14186-00-00
3	Float	676-14985-01-00
3	Pin, Float Arm	688-14548-00-00

Qty	Description	Part #
3	Gasket, Float Chamber	676-14984-00-00
3	Screw, With Washer	97980-04114-00
3	O-Ring	93210-04230-00
3	Gasket	663-14126-00-00
3	Screw, Pilot	692-14923-00-00

**115 / B115 / C115  
130 (96~) / S115  
S130  
6E5-W0093-09-00**

Kit Includes:

Qty	Description	Part #
2	Clip	6E5-14159-00-00
1	Gasket	6E5-14198-A2-00
2	Valve, Needle	6E5-14546-00-00
2	Pin, Float	6E5-14386-02-00
2	Valve, Drain	64D-14394-00-00
1	Gasket, Float Chamber	64D-14384-01-00

Qty	Description	Part #
2	Gasket	6E5-14398-01-00
2	Plug	6E5-14328-01-00
2	Gasket	6E5-14979-00-00
1	Gasket	6J8-14995-00-00
2	Gasket	61U-14959-00-00

**115 / 130 (90~91)  
6N6-W0093-02-00**

Kit Includes:

Qty	Description	Part #
1	Gasket	6K7-14483-00-00
2	Gasket	6E5-14198-A2-00
4	Valve, Needle	6E5-14546-00-00
4	Pin, Float	6E5-14386-02-00
4	Float	6E5-14385-02-00
2	Gasket, Float Chamber	6E5-14384-03-00
4	O-Ring	6E5-14997-00-00

Qty	Description	Part #
4	Gasket	6E5-14398-01-00
2	Screw, Panhead	97885-05016-00
2	Washer, Spring	92990-05100-00
4	Screw, Air Adjusting	6E5-14323-03-00
4	Gasket	6E5-14979-00-00
4	Gasket	6J8-14995-00-00
2	Gasket	6E5-14959-01-00

**115 (86~95) / C115 (92~95)  
130 (92~95) / 150 (86~95)  
175 (86~95) / 200 (86~95)  
225 2.6L (92~95)  
P115 (93~96)  
P150 (92~95) / P175  
P200 (92~95)  
PROV150 (87)  
V6 Special (86)  
6E5-W0093-06-00**

Kit Includes:

Qty	Description	Part #
1	Gasket	6E5-14198-A2-00
2	Valve, Needle	6E5-14546-00-00
2	Pin, Float	6E5-14386-02-00
1	Gasket, Float Chamber	6E5-14384-03-00
2	Gasket	6E5-14398-01-00
2	Gasket	6E5-14979-00-00

Qty	Description	Part #
2	Gasket	6J8-14995-00-00
1	Gasket	6E5-14959-01-00
2	Clip	6E5-14159-00-00
2	O-Ring	6E5-14997-00-00
2	Plug	6E5-14328-01-00

**150 (88~89)  
L150 (86~87)  
175 (88~89)  
200 (88~89)  
L200 (86~87, 89)  
PROV150 (88~89)  
6E5-W0093-06-00**

Kit Includes:

Qty	Description	Part #
1	Gasket	6G5-14483-A1-00
1	Gasket	6E5-14198-A2-00
6	Valve, Needle	6E5-14546-00-00
6	Pin, Float	6E5-14386-02-00
6	Float	6E5-14385-02-00
3	Gasket, Float Chamber	6E5-14384-03-00
6	O-Ring	6E5-14997-00-00

Qty	Description	Part #
6	Gasket	6E5-14398-01-00
3	Screw, Panhead	97885-05016-00
3	Washer, Spring	92990-05100-00
6	Screw, Air Adjusting	6E5-14323-03-00
6	Gasket	6E5-14979-00-00
6	Gasket	6J8-14995-00-00
3	Gasket	6E5-14959-01-00

\*Each carburetor kit will rebuild all carburetors on one motor.

## 2-Stroke Carburetor Repair Kits

**150 / 175 / 200  
225 (90~91) / P150  
P175 (90~91)  
P200 (90~91)  
ProV150  
6K7-W0093-08-00**

Kit Includes:

Qty	Description	Part #	Qty	Description	Part #
1	Gasket	6K7-14483-00-00	6	Gasket	6E5-14398-01-00
1	Gasket	6E5-14198-A2-00	3	Screw, With Washer	97885-05016-00
6	Valve, Needle	6E5-14546-00-00	3	Washer, Spring	92990-05100-00
6	Pin, Float	6E5-14386-02-00	6	Screw, Air Adjusting	6E5-14323-03-00
6	Float	6E5-14385-02-00	6	Gasket	6E5-14979-00-00
3	Gasket, Float Chamber	6E5-14384-03-00	6	Gasket	6J8-14995-00-00
6	O-Ring	6E5-14997-00-00	3	Gasket	6E5-14959-01-00

**150 / V150 / 175  
200 (96~01)  
225 2.6L (96~)  
P150 / P175  
P200 (96~99) / S150  
C150 / S175 / S200  
64D-W0093-01-00**

Kit Includes:

Qty	Description	Part #	Qty	Description	Part #
1	Gasket, Float Chamber	64D-14384-01-00	2	Gasket	6E5-14398-01-00
2	Valve, Needle	6E5-14546-00-00	2	Plug	6E5-14328-01-00
2	Clip	6E5-14159-00-00	2	Gasket	6E5-14979-00-00
2	Pin, Float	6E5-14386-02-00	1	Gasket	6J8-14995-00-00
2	Gasket	61U-14959-00-00	1	Gasket	6E5-14198-A2-00
2	Valve, Drain	64D-14394-00-00			

**150 / V150 (02~)  
64D-W0093-01-00**

Kit Includes:

Qty	Description	Part #	Qty	Description	Part #
1	Gasket, Float Chamber	64D-14384-01-00	2	Gasket	6E5-14398-01-00
2	Valve, Needle	6E5-14546-00-00	2	Plug	6E5-14328-01-00
2	Clip	6E5-14159-00-00	2	Gasket	6E5-14979-00-00
2	Pin, Float	6E5-14386-02-00	1	Gasket	6J8-14995-00-00
2	Gasket	61U-14959-00-00	1	Gasket	6E5-14198-A2-00
2	Valve, Drain	64D-14394-00-00			

**225 / 250 3.1L (90~96)  
S225 / S250  
61A-W0093-01-00**

Kit Includes:

Qty	Description	Part #	Qty	Description	Part #
1	Clip	6E5-14159-01-00	1	Gasket, Float Chamber	61A-14384-00-00
1	O-Ring	93210-50MA8-00	1	Screw, Air Adjusting	6E5-14323-03-00
1	Gasket	61A-14198-00-00	1	Gasket	61A-14995-00-00
1	Valve, Needle	6E5-14546-00-00	1	Gasket	61A-14959-00-00
1	Pin, Float	61A-14386-00-00	1	O-Ring	61A-14561-00-00
1	Valve, Drain	61A-14394-00-00			

\*Each carburetor kit will rebuild all carburetors on one motor.

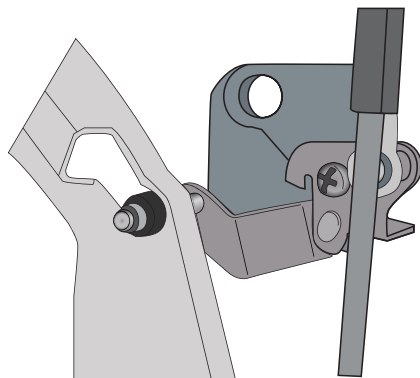

### Cam Roller

Cam rollers can wear over time. Stocking a few will help ensure your customers get the quick service they need. Used on most two strokes from 9.9 HP up.

**682-41291-00-00**



## Water Pump Housings

4 Stroke Application	Part Number
F2.5	69M-G4311-00-00
F4 (~06/2008)	68D-G4311-01-00
F4 (09/2009~)	6BX-44311-00-00
F8 / T8 (01~) F6 (~06/2008)	63V-44301-00-00
F9.9 / T9.9 (~04)	682-44300-02-00
F9.9 / T9.9 (05~)	63V-44301-00-00
F15 (98~)	63V-44301-00-00
F15C / F20	6AH-44311-00-00
F25	61N-44311-01-00
F25C / T25C	6L2-44311-01-00
T25 / F30 / F40 (00~)	66T-44311-00-00
F40 (99)	63D-44311-00-00
F50 / F60	63D-44311-00-00
T50 / T60	6H3-44311-00-00
F70	6CJ-44311-00-00
F75 / F80 / F90 / F100	67F-44311-01-00
F90B / VF90 / F115 / F115B / F150 / F200 / F225	61A-44311-01-00
VF200 / VF225 / VF250	61A-44311-01-00
F225 / F250 / F300 (4.2L)	6CE-44311-01-00
F250 / F250B	61A-44311-01-00
F350 (V6)	6CE-44311-01-00
F300 / F350 (V8)	6AW-44311-01-00
XTO® 425 / 450	6GR-44311-00-00

Jet Drive Application	Part Number
F40	67C-44311-10-00
F50/F60	62Y-44311-10-00
F75 / F80 / F90 / F100	67F-44311-11-00
F115	61A-44311-01-00
(Requires both part numbers)	6E5-44322-00-00

2 Stroke Application	Part Number
2	99999-02129-00
3	6L5-44311-00-00
4 / 5	6E0-44311-00-00
6 / 8	6GH-44311-00-00
9.9 / 15 (96)	63V-44301-00-00
9.9 / 15 (~95)	682-44300-02-00
20 / 25 Two Cyl	6L2-44311-01-00
25 / 30 Three Cyl	6J8-44311-00-00
C25	689-44311-03-00
C30 (93~97)	61N-44311-01-00
C30 (~92)	689-44311-03-00
40 / 50 / P50 (~94)	6J8-44311-00-00
40 / C40 / P40 / 50 / C50 / P50 (95~)	63D-44311-00-00
E48 / C55	663-44311-02-00
60 / C60 / P60 / E60 (~03)	6H3-44311-00-00
60 / 70 (04~) / C75 / E75 / P75 / 90	688-44311-01-00
C85 (92~95)	688-44311-01-00
C85 (89~91, 96~97)	67F-44311-01-00
115 / C115 / 130 (~92)	61A-44311-01-00
115 / B115 / C115 / P115 / S115 (93~)	61A-44311-01-00
130 / S130 (93~)	61A-44311-01-00
150 / P150 / 175 / 200 / 225 (~91)	61A-44311-01-00
V150 / VX150 (92~)	61A-44311-01-00
150 / C150 / D150 / DX150 (92~)	61A-44311-01-00
P150 / PX150 / P175 / P200 (92~)	61A-44311-01-00
S150 / SX150 / S200 / SX200	61A-44311-01-00
S225v SX225 / S250 / SX250	61A-44311-01-00
175v 200 / 225 / 250	61A-44311-01-00
V200 / VX200 / V225	61A-44311-01-00
VX225 / V250 / VX250	61A-44311-01-00
VZ150 / VZ175 / VZ200	61A-44311-01-00
VZ225 / VZ250 / VZ300	61A-44311-01-00
Z150 / Z175 / Z200 / Z250 / Z300	61A-44311-01-00

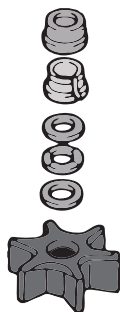

### Anti-Knock Washers

Required when changing a water pump on engines utilizing anti-knock washers.

Collar	61A-45527-00-00
Spacer	61A-45538-00-00
Plate Washer	90201-22M01-00
Wave Washer	90206-22M19-00

## T8 / T9.9 (04/2007~) - 69G-W0078-02-00

Kit Includes:

Qty	Description	Part #
1	Insert, Cartridge	63V-44322-00-00
1	Damper, Water Seal 2	68T-44366-01-00
1	Impeller	63V-44352-01-00
1	Key, Woodruff	664-44338-00-00
1	O-Ring	93210-44704-00
1	Outer Plate, Cartridge	68T-44323-00-00
4	Bolt	97095-08045-00

## F9.9 / T9.9 / FT9.9 (~96) - 682-W0078-A1-00

Kit Includes:

Qty	Description	Part #
2	Gasket, Water Pump	682-44315-A0-00
1	Insert, Cartridge	682-44322-00-00
1	Outer Plate, Cartridge	682-44323-00-00
1	Damper, Water Seal 1	682-44365-00-00
1	Key, Woodruff	90280-03024-00
4	Bolt	97095-06040-00
1	Impeller	682-44352-03-00

## F9.9 / T9.9 / FT9.9 (~96) / F9.9 / T9.9 (04~04/2005) / FT9.9 (04~04/2005) - 682-W0078-A3-00

Kit Includes:

Qty	Description	Part #
1	Damper, Water Seal 1	682-44365-00-00
4	Bolt	97080-06045-00
1	Insert, Cartridge	682-44322-00-00
1	Impeller	682-44352-03-00
2	Gasket, Water Pump	682-44315-A0-00
1	Outer Plate, Cartridge	682-44323-00-00
1	Key, Woodruff	90280-03024-00

## F9.9-2 / T9.9-2 / F15 - 63V-W0078-04-00

Kit Includes:

Qty	Description	Part #
1	Damper, Water Seal 2	647-44366-01-00
4	Bolt	97095-08045-00
1	Insert, Cartridge	63V-44322-00-00
1	Impeller	63V-44352-01-00
1	Outer Plate, Cartridge	63V-44323-00-00
1	Key, Woodruff	664-44338-00-00

## 4-Stroke Water Pump Repair Kits

### F2.5

Parts List (not sold as a kit):

Qty	Description	Part #
1	O-Ring	93210-33M85-00
1	Insert Cartridge	6L5-44322-00-00
1	Outer Plate Cartridge	69M-G4323-00-00
1	Damper, Water Seal 2	6E0-44366-01-00
1	Impeller	6L5-44352-00-00
4	Bolt	97095-06040-00
2	Pin, Dowel	93604-18080-00
2	Plate	6L5-44328-00-00

### F4 / F6 (09/2009~) - 6EE-W0078-01-00

Kit Includes:

Qty	Description	Part #
1	Housing, Water Pump	6EE-G4311-00-00
1	Gasket, Water Pump	6EE-G4315-00-00
1	Insert, Cartridge	6BX-44322-00-00
1	Outer Plate, Cartridge	6BX-44323-00-00
1	Damper, Water Seal 2	67D-44366-00-00
1	Impeller	6E0-44352-00-00
4	Bolt	97080-06045-00
2	Pin, Dowel	93604-18080-00

### F6 / F8 (~06/2008) - 68T-W0078-02-00

Kit Includes:

Qty	Description	Part #
1	Insert, Cartridge	63V-44322-00-00
1	Damper, Water Seal 2	68T-44366-01-00
1	Impeller	68T-44352-00-00
1	Key, Woodruff	664-44338-00-00
1	O-Ring	93210-44704-00
1	Outer Plate, Cartridge	68T-44323-00-00
4	Bolt	97095-08045-00

General Information

Rigging Estimate Guide (Diagrams)

Rigging Components

Electrical Components

Engine Accessories

Propellers

Maintenance Items

Yamaha & Trailer Supplies

Accessories & Apparel

## 4-Stroke Water Pump Repair Kits

### F15C / F20 - 6AH-W0078-02-00

Kit Includes:

Qty	Description	Part #
1	Housing, Water Pump	6AH-44311-00-00
1	Insert, Cartridge	63V-44322-00-00
1	Damper, Water Seal	6L2-44367-01-00
1	Impeller	63V-44352-01-00
1	Key, Woodruff	664-44338-00-00
1	O-Ring	93210-49046-00
1	Outer Plate, Cartridge	68T-44323-00-00
2	Pin, Dowel	93604-10M03-00
4	Bolt	97095-08045-00
2	Plate	63V-44328-01-00

### F25 / T25C - Water Pump Kit 6FM-W0078-02-00

Kit Includes:

Qty	Description	Part #
1	Housing, Water	6L2-44311-01-00
1	O-Ring	932-10451-61-00
1	Insert, Cartridge	6L2-44322-00-00
1	Outer Plate, Cartridge	6FM-44323-01-00
1	Impeller	6L2-44352-00-00
1	Outer Plate, Cartridge	68T-44323-00-00
4	Bolt, Hexagon Washer	97E-95065-40-00
2	Plate	6L2-44328-00-00
2	Pin, Dowel	93604-12M07-00
1	Key, Woodruff	90280-03024-00

### F25 - 61N-W0078-14-00

Kit Includes:

Qty	Description	Part #
1	Insert, Cartridge	63V-44322-00-00
1	Damper, Water Seal 3	6L2-44367-01-00
1	Impeller	63V-44352-01-00
1	Key, Woodruff	664-44338-00-00
1	O-Ring	93210-49046-00
1	Outer Plate, Cartridge	68T-44323-00-00
2	Pin, Dowel	93604-10M03-00
4	Bolt	97095-08045-00
2	Plate	63V-44328-01-00

### T25 / F30 / F40 (00~2009) - 66T-W0078-01-00

Kit Includes:

Qty	Description	Part #
1	Insert, Cartridge	63D-44322-00-00
1	Outer Plate, Cartridge	66T-44323-00-00
1	O-Ring	93210-59MG7-00
1	Gasket, Water Pump	63D-44316-00-00
1	Key, Woodruff	90280-03M03-00
1	Impeller	6H4-44352-02-00
4	Bolt, With Washer	90119-08M15-00
1	Damper, Water Seal 2	663-44366-01-00
1	Pump Housing Cover	63D-44312-00-00

### F40 (99) / F50 (97~) / F60 (02~) 63D-W0078-01-00

Kit Includes:

Qty	Description	Part #
1	Insert, Cartridge	63D-44322-00-00
1	Impeller	6H3-44352-00-00
1	Cover, Water Pump Housing	63D-44312-00-00
1	Outer Plate, Cartridge	63D-44323-00-00
1	O-Ring	93210-59MG7-00
1	Gasket, Water Pump	63D-44316-00-00
4	Bolt, With Washer	90119-08M15-00
1	Damper, Water Seal 2	663-44366-01-00
1	Key, Woodruff	90280-03024-00

### F40 (2010~) - 6BG-W0078-01-00

Kit Includes:

Qty	Description	Part #
1	Pump Housing Cover	63D-44312-00-00
1	Gasket, Water Pump	63D-44316-00-00
1	Insert Cartridge	63D-44322-00-00
1	Outer Plate, Cartridge	63D-44323-00-00
1	Damper, Water Seal 2	663-44366-01-00
1	Impeller	6H4-44352-02-00
4	Bolt, With Washer	90119-08M15-00
1	Key, Woodruff	90280-03M03-00
1	O-Ring	93210-59MG7-00

## F75, F80, F90, F100 - 67F-W0078-00-00

Kit Includes:

Qty	Description	Part #
1	Insert, Cartridge	67F-44322-00-00
1	Impeller	67F-44352-00-00
1	Gasket, Water Pump	688-44315-A0-00
1	Outer Plate, Cartridge	67F-44323-00-00
1	Gasket, Cartridge	688-44324-A0-00
1	Gasket, Water Pump	688-44316-A0-00
1	O-Ring	93210-46044-00
2	Bolt, With Washer	90119-08198-00
2	Bolt, With Washer	90119-08M13-00
1	Key, Woodruff	90280-04M04-00

## F115 (00~01) - 6N6-W0078-02-00

Kit Includes:

Qty	Description	Part #
1	Insert, Cartridge	61A-44322-02-00
1	O-Ring	93210-86M38-00
1	O-Ring	93210-37M67-00
1	Impeller	6E5-44352-01-00
1	Outer Plate, Cartridge	6E5-44323-00-00
1	Gasket, Water Pump	6E5-44315-A0-00
2	Pin, Dowel	93606-12019-00
4	Bolt, With Washer	90119-08191-00
1	Key, Woodruff	90280-04M05-00
1	Key, Woodruff	90280-04M04-00

## F115 (02~ ) - 68V-W0078-01-00

Kit Includes:

Qty	Description	Part #
1	Insert, Cartridge	61A-44322-02-00
1	O-Ring	93210-86M38-00
1	O-Ring	93210-37M67-00
1	Impeller	6E5-44352-01-00
1	Outer Plate, Cartridge	6EK-44323-00-00
1	Gasket, Water Pump	6E5-44315-A0-00
2	Pin, Dowel	93606-12019-00
4	Bolt, With Washer	90119-08191-00
1	Key, Woodruff	90280-04M05-00

## 4-Stroke Water Pump Repair Kits

### F50, T50 (96) - 6H3-W0078-A0-00

Kit Includes:

Qty	Description	Part #
1	Gasket, Water Pump	6H3-44315-A0-00
1	Outer Plate, Cartridge	6H3-44323-00-00
1	Gasket, Cartridge	6H3-44324-A0-00
1	Impeller	6H3-44352-00-00
1	Insert, Cartridge	663-44322-00-00
1	Gasket, Water Pump	688-44316-A0-00
1	Key, Woodruff	90280-03M03-00
1	O-Ring	93210-46044-00
4	Bolt	97095-08055-00
4	Bolt	97095-08045-00

### T50 / T60 (97~) - 6H3-W0078-02-00

Kit Includes:

Qty	Description	Part #
1	Insert, Cartridge	663-44322-00-00
1	Impeller	6H3-44352-00-00
1	Gasket, Water Pump	6H3-44315-A0-00
1	Outer Plate, Cartridge	6H3-44323-00-00
1	Gasket, Cartridge	6H3-44324-A0-00
1	Gasket, Water Pump	688-44316-A0-00
1	O-Ring	93210-46044-00
2	Bolt, With Washer	90119-08191-00
2	Bolt, With Washer	90119-08M33-00
1	Key, Woodruff	90280-03M03-00

### F70 - 6CJ-W0078-01-00

Kit Includes:

Qty	Description	Part #
1	Insert, Cartridge	63D-44322-00-00
1	Gasket, Water Pump	6CJ-44315-00-00
1	Cover, Pump Housing	63D-44312-00-00
1	Damper, Water Seal 2	663-44366-01-00
1	Impeller	6H3-44352-00-00
1	Key, Woodruff	90280-03M03-00
2	Oil Seal	93101-23070-00
1	O-Ring	93210-46044-00
1	Gasket, Water Pump	6CJ-44316-00-00
1	Outer Plate, Cartridge	6CJ-44323-00-00
1	Gasket, Cartridge	6CJ-44324-00-00
2	Pin, Dowel	93604-10M03-00
2	Bolt, With Washer	90119-08M33-00
2	Bolt, With Washer	90119-08191-00

General Information

Rigging Estimate Guide (Diagrams)

Rigging Components

Electrical Components

Engine Accessories

Propellers

Maintenance Items

Yamaha & Trailer Supplies

Accessories & Apparel

## 4-Stroke Water Pump Repair Kits

### F150 / F200 / F225 - 61A-W0078-A4-00

Kit Includes:

Qty	Description	Part #
1	Insert, Cartridge	61A-44322-02-00
1	O-Ring	93210-86M38-00
1	O-Ring	93210-37M67-00
1	Impeller	6E5-44352-01-00
1	Outer Plate, Cartridge	6G5-44323-01-00
1	Gasket, Water Pump	6E5-44315-A0-00
2	Pin, Dowel	93606-12019-00
4	Bolt, With Washer	90119-08191-00
1	Key, Woodruff	90280-04M05-00

### F300 / F350 (V8) - 6AW-W0078-00-00

Kit Includes:

Qty	Description	Part #
1	Insert, Cartridge	6AW-44322-00-00
1	O-Ring	93210-94003-00
1	O-Ring	93210-37M67-00
1	Impeller	6AW-44352-00-00
1	Key	6AW-44336-00-00
1	Outer Plate, Cartridge	6AW-44323-00-00
1	Gasket, Water Pump	6AW-44315-00-00
2	Pin, Dowel	93606-12019-00
4	Bolt, With Washer	90119-08191-00

### VF200 / VF225 / VF250 - 6CB-W0078-00-00

Kit Includes:

Qty	Description	Part #
1	Insert, Cartridge	61A-44322-02-00
1	O-Ring	93210-86M38-00
1	O-Ring	93210-37M67-00
1	Impeller	6E5-44352-01-00
1	Key, Woodruff	90280-04002-00
1	Outer Plate, Cartridge	6CB-44323-00-00
1	Gasket, Water Pump	6CB-44315-00-00
2	Pin, Dowel	93606-12019-00
4	Bolt, With Washer	90119-08191-00

### F250 / F250B - 6P2-W0078-00-00

Kit Includes:

Qty	Description	Part #
1	Insert, Cartridge	61A-44322-02-00
1	O-Ring	93210-86M38-00
1	O-Ring	93210-37M67-00
1	Impeller	6E5-44352-01-00
1	Outer Plate, Cartridge	6P2-44323-00-00
1	Gasket, Water Pump	60X-44315-A0-00
2	Pin, Dowel	93606-12019-00
4	Bolt, With Washer	90119-08191-00
1	Key, Woodruff	90280-04M05-00

### F225 / F250 / F300 (4.2L) / F350 (4.3L) - 6CE-W0078-02-00

Kit Includes:

Qty	Description	Part #
2	Oil Seal	93104-22M07-00
1	Insert, Cartridge	6AW-44322-00-00
1	O-Ring	93210-94003-00
1	O-Ring	93210-37M67-00
1	Impeller	6CE-44352-00-00
1	Key, Woodruff	90280-04002-00
1	Outer Plate, Cartridge	6CE-44323-01-00
1	Gasket, Water Pump	6CE-44315-00-00
2	Pin, Dowel	93606-12019-00
4	Bolt, With Washer	90119-08191-00

### XTO® 425 (2018~) / XTO® 450 (2023~) - 6GR-W0078-01-00

Kit Includes:

Qty	Description	Part #
1	Insert, Cartridge	6GR-44322-00-00
1	O-Ring	93210-97690-00
1	O-Ring	93211-08001-00
1	O-Ring	93210-37M67-00
1	Impeller	6GR-44352-00-00
1	Outer Plate, Cartridge	6GR-44323-00-00
2	Pin, Dowel	93606-12019-00
4	Bolt, With Washer	90119-08M16-00
1	Key	6AW-44336-00-00

## 2-Stroke Water Pump Repair Kits

### 4 / 5 (97~) - 6E0-W0078-A5-00

Kit Includes:

Qty	Description	Part #
1	Housing, Water Pump	6E0-44311-00-00
1	Gasket, Water Pump	6E0-44315-A0-00
1	Insert, Cartridge	6E0-44322-02-00
1	Outer Plate, Cartridge	6E0-44323-00-00
1	Damper, Water Seal 2	6E0-44366-01-00
1	Impeller	6E0-44352-00-00
4	Bolt	97080-06045-00
2	Pin Dowel	93604-18080-00

### 6 / 8 (96~) - 6N0-W0078-A0-00

Kit Includes:

Qty	Description	Part #
1	Gasket, Water Pump	6G1-44315-A0-00
1	Insert, Cartridge	6G1-44322-00-00
1	Outer Plate, Cartridge	6G1-44323-00-00
1	Damper, Water Seal 2	647-44366-00-00
1	Impeller	6G1-44352-00-00
2	Plate	6G1-44328-00-00
4	Bolt	97080-06045-00

### 9.9 / 15 (~95) - 682-W0078-A1-00

Kit Includes:

Qty	Description	Part #
2	Gasket, Water Pump	682-44315-A0-00
1	Insert, Cartridge	682-44322-00-00
1	Outer Plate, Cartridge	682-44323-00-00
1	Damper, Water Seal 1	682-44365-01-00
1	Key, Woodruff	90280-03024-00
4	Bolt	97095-06040-00
1	Impeller	682-44352-03-00

### 9.9 / 15 (96~) - 63V-W0078-04-00

Kit Includes:

Qty	Description	Part #
1	Damper, Water Seal 2	647-44366-01-00
4	Bolt	97095-08045-00
1	Insert, Cartridge	63V-44322-00-00
1	Impeller	63V-44352-01-00
1	Outer Plate, Cartridge	63V-44323-00-00
1	Key, Woodruff	664-44338-00-00

### 2 (89~02) - 6GD-W0078-00-00

Kit Includes:

Qty	Description	Part #
2	Pin, Dowel	93604-09068-00
1	O-Ring	93210-19123-00
2	Oil Seal	93101-11M44-00
1	Outer Plate, Cartridge	646-44323-00-00
1	Impeller	646-44352-01-00
1	Insert, Cartridge	6GD-G4322-00-00
1	Protector, Oil Seal	6GD-44325-00-00
2	Bolt	97095-05016-00

### 3 (88~02) - 6L5-W0078-00-00

Kit Includes:

Qty	Description	Part #
1	O-Ring	93210-33M85-00
1	Insert, Cartridge	6L5-44322-00-00
1	Outer Plate, Cartridge	6L5-44323-00-00
1	Damper, Water Seal 2	6E0-44366-01-00
1	Impeller	6L5-44352-00-00
4	Bolt	97095-06040-00
2	Pin, Dowel	93604-18080-00
2	Plate	6L5-44328-00-00

### 4 / 5 (~96) - 6E0-W0078-A2-00

Kit Includes:

Qty	Description	Part #
1	Housing, Water Pump	6E0-44311-00-00
1	Gasket, Water Pump	6E0-44315-A0-00
1	Insert, Cartridge	6E0-44322-02-00
1	Outer Plate, Cartridge	6E0-44323-00-00
1	Impeller	6E0-44352-00-00
1	Damper, Water Seal 2	6E0-44366-01-00
1	Pin, Dowel	93604-09066-00
4	Bolt	97080-06045-00

# Maintenance Items

General Information

Rigging Estimate Guide (Diagrams)

Rigging Components

Electrical Components

Engine Accessories

Propellers

**Maintenance Items**

Yamalube & Trailer Supplies

Accessories & Apparel

## 2-Stroke Water Pump Repair Kits

### 20 / 25 Two Cylinder - 6L2-W0078-00-00

Kit Includes:

Qty	Description	Part #
1	Outer Plate, Cartridge	6L2-44323-00-00
1	O-Ring	93210-45161-00
1	Impeller	6L2-44352-00-00
1	Insert, Cartridge	6L2-44322-00-00
4	Bolt	97095-06040-00
1	Key, Woodruff	90280-03024-00

### 25 / 30 Three Cylinder (96~02)

#### 6J8-W0078-A2-00

Kit Includes:

Qty	Description	Part #
1	Insert, Cartridge	663-44322-00-00
1	Impeller	6H4-44352-02-00
1	Gasket, Water Pump	663-44315-A0-00
1	Outer Plate, Cartridge	663-44323-00-00
1	Gasket, Cartridge	663-44324-A0-00
1	Gasket, Water Pump	663-44316-A0-00
2	Bolt, With Washer	90119-08M13-00
2	Bolt, With Washer	90119-08M34-00

### C25 (90~97), C30 (90~92) - 689-W0078-A6-00

Kit Includes:

Qty	Description	Part #
1	Damper, Water Seal 1	626-44365-02-00
1	Housing, Water Pump	689-44311-03-00
3	Bolt, With Washer	90119-06M07-00
1	Insert, Cartridge	689-W4432-02-00
1	Outer Plate, Cartridge	689-44323-03-00
1	Gasket, Cartridge	689-44324-A0-00
1	Impeller	689-44352-02-00
1	Gasket, Water Pump	689-44316-A0-00
1	Key, Woodruff	664-44338-00-00

### 30 (~95) - 6J8-W0078-A1-00

Kit Includes:

Qty	Description	Part #
1	Impeller	6H4-44352-02-00
1	Gasket, Water Pump	663-44315-A0-00
1	Gasket, Water Pump	663-44316-A0-00
1	Insert, Cartridge	663-44322-00-00
1	Outer Plate, Cartridge	663-44323-00-00
1	Gasket, Cartridge	663-44324-A0-00
2	Bolt	97095-08040-00
2	Bolt	97095-08050-00

### C30 (93~97) - 61N-W0078-14-00

Kit Includes:

Qty	Description	Part #
1	Housing, Water Pump	61N-44311-01-00
1	Damper, Water Seal 3	6L2-44367-01-00
1	Insert, Cartridge	61N-44322-01-00
1	Impeller	6H4-44352-02-00
1	O-Ring	93210-45161-00
1	Outer Plate, Cartridge	61N-44323-00-00
4	Bolt	97095-06040-00
4	Washer	92990-06600-00
1	Key, Woodruff	90280-03024-00

### 40 / 50 P50 / (~96) - 63D-W0078-00-00

Kit Includes:

Qty	Description	Part #
1	Gasket, Water Pump	63D-44316-00-00
1	Outer Plate, Cartridge	63D-44323-00-00
1	Impeller	6H3-44352-00-00
1	Insert, Cartridge	63D-44322-00-00
1	Gasket, Water Pump	63D-44316-00-00
1	Key, Woodruff	90280-03024-00
1	O-Ring	93210-59MG7-00
4	Bolt	97080-08030-00
4	Washer, Special Shape	90209-08M02-00

### 40 / C40 (98~03) / P40 / 50 / C50 /

#### P50 (97~) - 63D-W0078-03-00

Kit Includes:

Qty	Description	Part #
1	Insert, Cartridge	63D-44322-00-00
1	Impeller	6H3-44352-00-00
1	Cover, Pump Housing	63D-44312-00-00
1	Outer Plate, Cartridge	63D-44323-00-00
1	O-Ring	93210-59MG7-00
1	Gasket, Water Pump	63D-44316-00-00
4	Bolt, With Washer	90119-08M15-00
1	Damper, Water Seal 2	663-44366-01-00
1	Key, Woodruff	90280-03024-00

## C55 (90~91) - 663-W0078-A0-00

Kit Includes:

Qty	Description	Part #
1	Gasket, Water Pump	663-44315-A0-00
1	Insert, Cartridge	663-44322-00-00
1	Outer Plate, Cartridge	663-44323-00-00
1	Gasket, Cartridge	663-44324-A0-00
1	Damper, Water Seal 2	663-44366-01-00
1	Impeller	6H3-44352-00-00
1	Key, Woodruff	90290-03M03-00
2	Bolt	97095-08045-00
2	Bolt	97095-08055-00

## C55 (92~94) - 663-W0078-01-00

Kit Includes:

Qty	Description	Part #
1	Insert, Cartridge	663-44322-00-00
1	Impeller	6H3-44352-00-00
1	Gasket, Water Pump	663-44315-A0-00
1	Outer Plate, Cartridge	663-44323-00-00
1	Gasket, Cartridge	663-44324-A0-00
2	Bolt	97095-08055-00
2	Bolt	97095-08045-00
1	Damper, Water Seal 2	663-44366-01-00
1	Key, Woodruff	90280-03M03-00

## 60 / 70 (04~) / C75 / P75 / C80 / 90 / B90 / C90 (97~) / E75 - 692-W0078-02-00

Kit Includes:

Qty	Description	Part #
1	Insert, Cartridge	688-44322-00-00
1	Impeller	688-44352-03-00
1	Gasket, Water Pump	688-44315-A0-00
1	Outer Plate, Cartridge	688-44323-00-00
1	Gasket, Cartridge	688-44324-A0-00
1	Gasket, Water Pump	688-44316-A0-00
1	O-Ring	93210-46044-00
2	Bolt, With Washer	90119-08M13-00
2	Bolt, With Washer	90119-08M16-00
1	Key, Woodruff	90280-04M04-00

## 2-Stroke Water Pump Repair Kits

### CV40 (90) - 6F5-W0078-A0-00

Kit Includes:

Qty	Description	Part #
1	Damper, Water Seal 2	663-44366-01-00
1	Insert, Cartridge	676-44322-00-00
1	Impeller	6F5-44352-00-00
1	Gasket, Water Pump	676-44315-A1-00
1	Outer Plate, Cartridge	676-44323-00-00
1	Gasket, Cartridge	676-44324-A1-00
1	Gasket, Water Pump	679-44316-A0-00
2	Bolt	97095-08055-00
2	Bolt	97095-08045-00
4	Washer	92990-08600-00
1	Key, Woodruff	90280-04M00-00

### C40 (91~97) - 679-W0078-A1-00

Kit Includes:

Qty	Description	Part #
1	Damper, Water Seal 2	663-44366-01-00
1	Insert, Cartridge	676-44322-00-00
1	Impeller	6F5-44352-00-00
1	Gasket, Water Pump	676-44315-A1-00
1	Outer Plate, Cartridge	676-44323-00-00
1	Gasket, Cartridge	676-44324-A1-00
1	Gasket, Water Pump	679-44316-A0-00
2	Bolt	97095-08055-00
2	Bolt	97095-08045-00
1	Key, Woodruff	90280-04M00-00

### E48 (95~00) - 696-W0078-00-00

Kit Includes:

Qty	Description	Part #
1	Insert, Cartridge	663-44322-40-00
1	Impeller	6H3-44352-00-00
1	Gasket, Water Pump	663-44315-A0-00
1	Outer Plate, Cartridge	670-44323-00-00
1	Gasket, Cartridge	663-44324-A0-00
2	Bolt	97095-08055-00
2	Bolt	97095-08045-00
1	Damper, Water Seal 2	663-44366-01-00
1	Key, Woodruff	90280-03M03-00

General Information

Rigging Estimate Guide (Diagrams)

Rigging Components

Electrical Components

Engine Accessories

Propellers

Maintenance Items

Yamaha & Trailer Supplies

Accessories & Apparel



## 2-Stroke Water Pump Repair Kits

### E60 (97~00) - 6K5-W0078-01-00

Kit Includes:

Qty	Description	Part #
1	Insert, Cartridge	663-44322-40-00
1	Impeller	6H3-44352-00-00
1	Gasket, Water Pump	6H3-44315-A0-00
1	Outer Plate, Cartridge	6H3-44323-40-00
1	Gasket, Cartridge	6H3-44324-A0-00
1	Gasket, Water Pump	688-44316-A0-00
1	O-Ring	93210-46044-00
2	Bolt, With Washer	90119-08M33-00
2	Bolt, With Washer	90119-08191-00
1	Key, Woodruff	90280-03M03-00

### 60 / C60 / P60 / 70 / C70 (97~03) 6H3-W0078-02-00

Kit Includes:

Qty	Description	Part #
1	Insert Cartridge	663-44322-00-00
1	Impeller	6H3-44352-00-00
1	Gasket, Water Pump	6H3-44315-A0-00
1	Outer Plate, Cartridge	6H3-44323-00-00
1	Gasket, Cartridge	6H3-44324-A0-00
1	Gasket, Water Pump	688-44316-A0-00
1	O-Ring	93210-46044-00
2	Bolt, With Washer	90119-08191-00
2	Bolt, With Washer	90119-08M33-00
1	Key, Woodruff	90280-03M03-00

### C60 / E60 / P60 / 70 (92~96) - 6H3-W0078-01-00

Kit Includes:

Qty	Description	Part #
1	Insert, Cartridge	663-44322-00-00
1	Impeller	6H3-44352-00-00
1	Gasket, Water Pump	6H3-44315-A0-00
1	Outer Plate, Cartridge	6H3-44323-00-00
1	Gasket, Cartridge	6H3-44324-A0-00
1	Gasket, Water Pump	688-44316-A0-00
1	O-Ring	93210-46044-00
2	Bolt	97095-08045-00
2	Bolt	97095-08055-00
1	Key, Woodruff	90280-03M03-00

### C85 (91) / CV85 (89~90), 90 (84~91) - 692-W0078-A0-00

Kit Includes:

Qty	Description	Part #
1	Gasket, Water Pump	688-44315-A0-00
1	Gasket, Water Pump	688-44316-A0-00
1	Insert, Cartridge	688-44322-00-00
1	Outer Plate, Cartridge	688-44323-00-00
1	Gasket, Cartridge	688-44324-A0-00
1	Impeller	688-44352-03-00
1	Key, Woodruff	90280-04M04-00
1	O-Ring	93210-46044-00
2	Bolt	97095-08050-00
2	Bolt	97095-08070-00

### E75 (95~96) / P75 (96) / C75 (94~96) / C85 / 90 (92~96) - 692-W0078-A0-00

Kit Includes:

Qty	Description	Part #
1	Insert, Cartridge	688-44322-00-00
1	Impeller	688-44352-03-00
1	Gasket, Water Pump	688-44315-A0-00
1	Outer Plate, Cartridge	688-44323-00-00
1	Gasket, Cartridge	688-44324-A0-00
1	Gasket, Water Pump	688-44316-A0-00
1	O-Ring	93210-46044-00
2	Bolt	97095-08050-00
2	Bolt	97095-08070-00
1	Key, Woodruff	90280-04M04-00

### 115 / C115 / 130 (~92) - 6E5-W0078-A1-00

Kit Includes:

Qty	Description	Part #
1	Gasket, Water Pump	6E5-44315-A0-00
1	Insert, Cartridge	6E5-44322-00-00
1	Outer Plate, Cartridge	6E5-44323-00-00
1	Impeller	6E5-44352-01-00
4	Washer	90209-08M02-00
1	Key, Woodruff	90280-04M05-00
1	O-Ring	93210-37M67-00
1	O-Ring	93210-86M38-00
2	Pin, Dowel	93606-12019-00
4	Bolt	97080-08045-00

## 2-Stroke Water Pump Repair Kits

**115 / C115 / P115 / S115 (96~99) / 130 (93~96) - 6N6-W0078-00-00**

Kit Includes:

Qty	Description	Part #
1	Insert, Cartridge	61A-44322-00-00
1	O-Ring	93210-86M38-00
1	O-Ring	93210-37M67-00
1	Impeller	6E5-44352-01-00
1	Outer Plate, Cartridge	6E5-44323-00-00
1	Gasket, Water Pump	6E5-44315-A0-00
1	Pin, Dowel	93606-12019-00
4	Bolt	97095-08045-00
4	Washer	90209-08M02-00
1	Key, Woodruff	90280-04M05-00

**115 / C115 (97~) - 6N6-W0078-02-00**

Kit Includes:

Qty	Description	Part #
1	Insert, Cartridge	61A-44322-02-00
1	O-Ring	93210-86M38-00
1	O-Ring	93210-37M67-00
1	Impeller	6E5-44352-01-00
1	Outer Plate, Cartridge	6E5-44323-00-00
1	Gasket, Water Pump	6E5-44315-A0-00
2	Pin, Dowel	93606-12019-00
4	Bolt, With Washer	90119-08191-00
1	Key, Woodruff	90280-04M05-00

**150 / P150 / 175 / 200 / 225 (~91) - 6G5-W0078-A1-00**

Kit Includes:

Qty	Description	Part #
1	Gasket, Water Pump	6E5-44315-A0-00
1	Insert, Cartridge	6E5-44322-00-00
1	Impeller	6E5-44352-01-00
1	Outer Plate, Cartridge	6G5-44323-01-00
4	Washer	90209-08M02-00
1	Key, Woodruff	90280-04M05-00
1	O-Ring	93210-37M67-00
1	O-Ring	93210-86M38-00
1	Pin, Dowel	93606-12019-00
4	Bolt	97095-08045-00

**D150 / DX150 / B115 (97~99) - 65N-W0078-A1-00**

Kit Includes:

Qty	Description	Part #
1	Insert, Cartridge	61A-44322-02-00
1	O-Ring	93210-86M38-00
1	O-Ring	93210-37M67-00
1	Impeller	6E5-44352-01-00
1	Outer Plate, Cartridge	65N-44323-00-00
1	Gasket, Water Pump	65N-44315-A0-00
1	Key, Woodruff	90280-04M05-00
2	Pin, Dowel	93606-12019-00
4	Bolt, With Washer	90119-08191-00

**P150 (92~96) / P175 (94~96) / P200 (91~96) / C150 (96) / 150~225 (96) / L150~L250 (96) / S150~S250 (96) - 61A-W0078-A1-00**

Kit Includes:

Qty	Description	Part #
1	Insert, Cartridge	61A-44322-00-00
1	O-Ring	93210-86M38-00
1	O-Ring	93210-37M67-00
1	Impeller	6E5-44352-01-00
1	Outer Plate, Cartridge	6G5-44323-01-00
1	Gasket, Water Pump	6E5-44315-A0-00
2	Pin, Dowel	93606-12019-00
4	Bolt	97095-08045-00
4	Washer	90209-08M02-00
1	Key, Woodruff	90280-04M05-00

**VZ200 (3.1L) / VZ225~VZ300 (03~) - 60X-W0078-00-00**

Kit Includes:

Qty	Description	Part #
1	Insert, Cartridge	61A-44322-02-00
1	O-Ring	93210-86M38-00
1	O-Ring	93210-37M67-00
1	Impeller	6E5-44352-01-00
1	Outer Plate, Cartridge	60X-44323-00-00
1	Gasket, Water Pump	60X-44315-A0-00
2	Pin, Dowel	93606-12019-00
4	Bolt, With Washer	90119-08191-00
1	Key, Woodruff	90280-04M05-00

## 2-Stroke Water Pump Repair Kits

225 / 250 (92~) / S150 / SX150 / S200 / SX200  
 / S250 / SX250 / V150~V250 / VX150~VX250  
 / VZ150~VZ200 (2.6L) / Z150~Z300 /  
 P150~P200 / C150 (97~99) / PX150 (99) -  
**61A-W0078-A4-00**

Kit Includes:

Qty	Description	Part #
1	Insert, Cartridge	61A-44322-02-00
1	O-Ring	93210-86M38-00
1	O-Ring	93210-37M67-00
1	Impeller	6E5-44352-01-00
1	Outer Plate, Cartridge	6G5-44323-01-00
1	Gasket, Water Pump	6E5-44315-A0-00
2	Pin, Dowel	93606-12019-00
4	Bolt, With Washer	90119-08191-00
1	Key, Woodruff	90280-04M05-00

## REMINDER

Don't forget the WR No. 2 grease for the driveshaft splines when reinstalling the lower unit after water services.

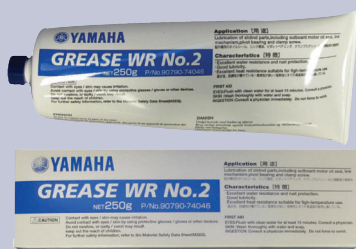

### WR No. 2 Grease

Provides water resistance, rust protection, lubrication and heat resistance. Specially designed for four stroke oil pump seals, drive shaft splines and drive shaft bushing area. For four stroke and two stroke applications.

90790-74068-00

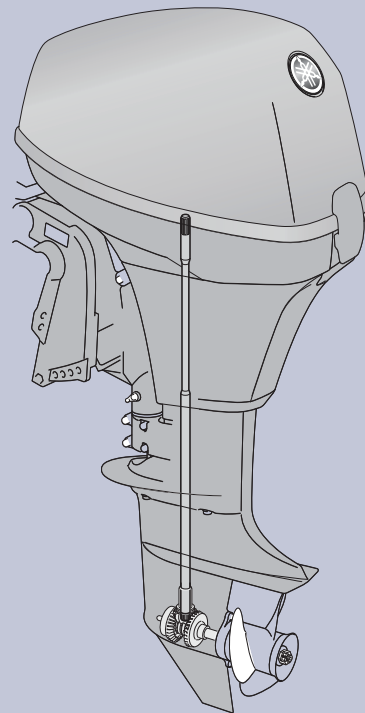

# ALL-NEW 100-Hour Service Kit

By **Will Leonard**, Product Manager



In the age where maintenance is paramount to the longevity of your motor, we are excited to announce an addition to our Maintenance Kit lineup—the all-new 100-Hour Service Kits. With the introduction of these kits, Yamaha helps to fulfill our commitment to our customer base to consistently improve our product offering in an ever-evolving marine industry.

These kits were designed to meet the demands of some of our most popular engines ranging from 115 horsepower to 300 horsepower. Within the lineup there are four kits:

- **6EK-W006A-00-00**
- **63P-W006A-00-00**
- **6DA-W006A-00-00**
- **6CE-W006A-00-00**

Please refer to the fitment chart below for details on each part number.



Service Kit	Model	Displacement	Primary Prefix	Oil Change Kit Recommended Option 1	Oil Change Kit Recommended Option 2
 6EK-W006A-00-00	F115LB	In-Line Four 1.8L	6EKL	LUB-MRNMD-KT-11 (10W-30)	LUB-MRNMD-KT-21 (20W-40)
	F115XB	In-Line Four 1.8L	6EKX	LUB-MRNMD-KT-11 (10W-30)	LUB-MRNMD-KT-21 (20W-40)
	LF115XB	In-Line Four 1.8L	6ELX	LUB-MRNMD-KT-11 (10W-30)	LUB-MRNMD-KT-21 (20W-40)
	VF115LA	V MAX SHO 1.8L	6FNL	LUB-MRNMD-KT-11 (10W-30)	LUB-MRNMD-KT-21 (20W-40)
	VF115XA	V MAX SHO 1.8L	6FNX	LUB-MRNMD-KT-11 (10W-30)	LUB-MRNMD-KT-21 (20W-40)
 63P-W006A-00-00	F150LB	In-Line Four 2.7L	63PL	LUB-MRNMR-KT-10 (10W-30)	LUB-MRNMR-KT-20 (20W-40)
	F150XB	In-Line Four 2.7L	63PX	LUB-MRNMR-KT-10 (10W-30)	LUB-MRNMR-KT-20 (20W-40)
	LF150XB	In-Line Four 2.7L	64PX	LUB-MRNMR-KT-10 (10W-30)	LUB-MRNMR-KT-20 (20W-40)
 6DA-W006A-00-00	F150LCA	In-Line Four 2.8L	6HPL	LUB-MRNMR-KT-10 (10W-30)	LUB-MRNMR-KT-20 (20W-40)
	F150XCA	In-Line Four 2.8L	6HPX	LUB-MRNMR-KT-10 (10W-30)	LUB-MRNMR-KT-20 (20W-40)
	LF150XCA	In-Line Four 2.8L	6HRX	LUB-MRNMR-KT-10 (10W-30)	LUB-MRNMR-KT-20 (20W-40)
	F150XSA	In-Line Four 2.8L	6LMX	LUB-MRNMR-KT-10 (10W-30)	LUB-MRNMR-KT-20 (20W-40)
	LF150XSA	In-Line Four 2.8L	6LNX	LUB-MRNMR-KT-10 (10W-30)	LUB-MRNMR-KT-20 (20W40)
	VF150LA	V MAX SHO 2.8L	6EHL	LUB-MRNMR-KT-10 (10W-30)	LUB-MRNMR-KT-20 (20W-40)
	VF150XA	V MAX SHO 2.8L	6EHX	LUB-MRNMR-KT-10 (10W-30)	LUB-MRNMR-KT-20 (20W-40)
	F175LA	In-Line Four 2.8L	6FAL	LUB-MRNMR-KT-10 (10W-30)	LUB-MRNMR-KT-20 (20W-40)
	F175XA	In-Line Four 2.8L	6FAX	LUB-MRNMR-KT-10 (10W-30)	LUB-MRNMR-KT-20 (20W-40)
	F175LCA	In-Line Four 2.8L	6HSL	LUB-MRNMR-KT-10 (10W-30)	LUB-MRNMR-KT-20 (20W-40)
	F175XCA	In-Line Four 2.8L	6HSX	LUB-MRNMR-KT-10 (10W-30)	LUB-MRNMR-KT-20 (20W-40)
	LF175XCA	In-Line Four 2.8L	6HTX	LUB-MRNMR-KT-10 (10W-30)	LUB-MRNMR-KT-20 (20W-40)
	VF175LA	V MAX SHO 2.8L	6FHL	LUB-MRNMR-KT-10 (10W-30)	LUB-MRNMR-KT-20 (20W-40)
	VF175XA	V MAX SHO 2.8L	6FHX	LUB-MRNMR-KT-10 (10W-30)	LUB-MRNMR-KT-20 (20W-40)
	F200LB	In-Line Four 2.8L	6DAL	LUB-MRNMR-KT-10 (10W-30)	LUB-MRNMR-KT-20 (20W-40)

# Maintenance Items

General Information

Rigging Estimate Guide (Diagrams)

Rigging Components

Electrical Components



Engine Accessories

Propellers

Maintenance Items

Yamalube & Trailer Supplies

Accessories & Apparel

Service Kit	Model	Displacement	Primary Prefix	Oil Change Kit Recommended Option 1	Oil Change Kit Recommended Option 2
 <p>6DA-W006A-00-00</p>	F200XB	In-Line Four 2.8L	6DAX	LUB-MRNMR-KT-10 (10W-30)	LUB-MRNMR-KT-20 (20W-40)
	LF200XB	In-Line Four 2.8L	6DBX	LUB-MRNMR-KT-10 (10W-30)	LUB-MRNMR-KT-20 (20W-40)
	F200LCA	In-Line Four 2.8L	6DVL	LUB-MRNMR-KT-10 (10W-30)	LUB-MRNMR-KT-20 (20W-40)
	LF200LCA	In-Line Four 2.8L	6DWL	LUB-MRNMR-KT-10 (10W-30)	LUB-MRNMR-KT-20 (20W-40)
	F200XCA	In-Line Four 2.8L	6DVX	LUB-MRNMR-KT-10 (10W-30)	LUB-MRNMR-KT-20 (20W-40)
	LF200XCA	In-Line Four 2.8L	6DWX	LUB-MRNMR-KT-10 (10W-30)	LUB-MRNMR-KT-20 (20W-40)
	F200XSA	In-Line Four 2.8L	6LHX	LUB-MRNMR-KT-10 (10W-30)	LUB-MRNMR-KT-20 (20W-40)
LF200XSA	In-Line Four 2.8L	6LJX	LUB-MRNMR-KT-10 (10W-30)	LUB-MRNMR-KT-20 (20W-40)	
 <p>6CE-W006A-00-00</p>	VF200XB	V MAX SHO 4.2L	6LGX	LUB-MRNSH-KT-05 (5W-30)	N/A
	F225XB	Offshore 4.2L	6HBX	LUB-MRNXL-KT-10 (10W-30)	LUB-MRNXL-KT-20 (20W-40)
	LF225XB	Offshore 4.2L	6HCX	LUB-MRNXL-KT-10 (10W-30)	LUB-MRNXL-KT-20 (20W-40)
	F225NCB	Offshore 4.2L	6KKN	LUB-MRNXL-KT-10 (10W-30)	LUB-MRNXL-KT-20 (20W-40)
	F225XCB	Offshore 4.2L	6KHX	LUB-MRNXL-KT-10 (10W-30)	LUB-MRNXL-KT-20 (20W-40)
	F250NCB	Offshore 4.2L	6KHN	LUB-MRNXL-KT-10 (10W-30)	LUB-MRNXL-KT-20 (20W-40)
	F250NSB	Offshore 4.2L	6KDN	LUB-MRNXL-KT-10 (10W-30)	LUB-MRNXL-KT-20 (20W-40)
	F250XB	Offshore 4.2L	6HDX	LUB-MRNXL-KT-10 (10W-30)	LUB-MRNXL-KT-20 (20W-40)
	LF250XB	Offshore 4.2L	6HEX	LUB-MRNXL-KT-10 (10W-30)	LUB-MRNXL-KT-20 (20W-40)
	VF250XB	V MAX SHO 4.2L	6LFX	LUB-MRNSH-KT-05 (5W-30)	N/A
	F250XCB	Offshore 4.2L	6KHX	LUB-MRNXL-KT-10 (10W-30)	LUB-MRNXL-KT-20 (20W-40)
	LF250XCB	Offshore 4.2L	6KJX	LUB-MRNXL-KT-10 (10W-30)	LUB-MRNXL-KT-20 (20W-40)
	F250XSB	Offshore 4.2L	6KDX	LUB-MRNXL-KT-10 (10W-30)	LUB-MRNXL-KT-20 (20W-40)
	LF250XSB	Offshore 4.2L	6KEX	LUB-MRNXL-KT-10 (10W-30)	LUB-MRNXL-KT-20 (20W-40)
	F300NCB	Offshore 4.2L	6KFN	LUB-MRNXL-KT-10 (10W-30)	LUB-MRNXL-KT-20 (20W-40)
	F300NSB	Offshore 4.2L	6KAN	LUB-MRNXL-KT-10 (10W-30)	LUB-MRNXL-KT-20 (20W-40)
	F300XCB	Offshore 4.2L	6KFX	LUB-MRNXL-KT-10 (10W-30)	LUB-MRNXL-KT-20 (20W-40)
	LF300XCB	Offshore 4.2L	6KGX	LUB-MRNXL-KT-10 (10W-30)	LUB-MRNXL-KT-20 (20W-40)
	F300XSB	Offshore 4.2L	6KAX	LUB-MRNXL-KT-10 (10W-30)	LUB-MRNXL-KT-20 (20W-40)
	LF300XSB	Offshore 4.2L	6KBX	LUB-MRNXL-KT-10 (10W-30)	LUB-MRNXL-KT-20 (20W-40)
F300UCB	Offshore 4.2L	6KFU	LUB-MRNXL-KT-10 (10W-30)	LUB-MRNXL-KT-20 (20W-40)	
LF300UCB	Offshore 4.2L	6KGU	LUB-MRNXL-KT-10 (10W-30)	LUB-MRNXL-KT-20 (20W-40)	
F300USB	Offshore 4.2L	6KAU	LUB-MRNXL-KT-10 (10W-30)	LUB-MRNXL-KT-20 (20W-40)	
LF300USB	Offshore 4.2L	6KBU	LUB-MRNXL-KT-10 (10W-30)	LUB-MRNXL-KT-20 (20W-40)	

\*In case of inquiry, please refer to Owner's Manual for maintenance schedule.

## Maintenance Kit Components

Each kit includes all the hardware to replace the external anodes, fuel filter and gasket, hardware to swap out the water pump impeller, thermostat, and coordinating gaskets, as well as spark plugs for the outboard. These kits were designed for our customers to use every 100 hours or each year—whichever comes first. Bear in mind, that these kits are not merely a replacement for our trustworthy oil change kits, but used in addition to the oil change kit, gear lube, and lower unit pump. Ordering all these parts will help ensure coverage for a full service at a dealership or in the comfort of the customer's driveway.

## What Is the Application?

No matter if you are at a dealership streamlining your order fulfillment, a Do-It-Yourself (DIY) owner looking to maintain their outboard, or on a dinghy servicing a

boat in-water at a Marina, these kits bridge the gap by providing the replacement components needed for success. Not only do you have everything you need to service the internal parts of the engine at this given service interval, but it is also accomplishing this at discounted rate from the cost of buying all the parts individually. This is a win-win not only for Yamaha, but the consumer as well.

Introducing reliable products to the marketplace such as our outboards and providing the necessary parts, such as these maintenance kits, will provide a better overall customer experience on the water. Many thanks to the men and women at the Yamaha Global Parts Center who have made this idea a reality for us. We look forward to serving our customers by providing the best parts and service each and every day.

Notes: [Lined area for handwritten notes]

General Information

Rigging Estimate Guide (Diagrams)

Rigging Components

Electrical Components

Engine Accessories

Propellers

**Maintenance Items**

Yamaha & Trailer Supplies

Accessories & Apparel



<b>Description</b>	<b>Page</b>
Oil and Lubes POP (Point of Purchase) Material	8-1
Outboard Engine Oil	8-2
Outboard Oil Change Kits	8-3
Pumps and Spouts	8-4
Fuel Additives	8-6
Grease	8-7
Yamabond® Adhesives	8-9
Shop Supplies	8-10
For the Technician	8-12
Cleaning Chemicals	8-13
Tire Repair and Supplies	8-14
Locks and Security	8-14
Trailer Repair Supplies	8-15
Tie Downs and Straps	8-16
YDIS (Yamaha Diagnostic System)	8-17

General  
Information

Rigging Estimate  
Guide (Diagrams)

Rigging  
Components

Electrical  
Components

Engine  
Accessories

Propellers

Maintenance  
Items

Yamalube &  
Trailer Supplies

Accessories  
& Apparel





## Oil and Lubes POP Material

### YAMALUBE® Marine Performance

There are many reasons you chose a Yamaha Outboard. Performance, Technology, Durability, and an enjoyable boating experience you can look forward to thanks to Yamaha's legendary reliability. Using Genuine Yamaha oils and maintenance parts along with a regular maintenance schedule can help your customers get the most out of their engines and their boating experience.

Yamaha offers a variety of material to help you convey the importance of proper maintenance and the advantage of Genuine Yamaha parts, most at little or no cost to you.

### Point of Purchase Items:

- YAMALUBE® Counter Mats: **LIT-CNTRM-AT-21**
- Ethanol Defense Brochures: **LIT-YAMAL-BR-OC**
- Maintenance Matters® Brochures: **LIT-MNTMT-RS-22**
- Trailer Tongue Guards (5 pack): **LIT-TRTNG-GR-D0**
- Display Bottle: **LUB-BOTTL-DS-03**
- Roller Cart: **LUB-BOTTL-DS-04**

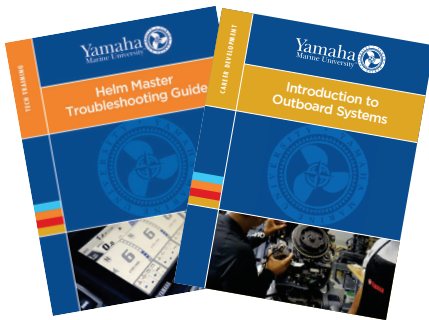

### Introduction to Outboards Training Material:

- Instructors Guide: **MAR-TTRNG-01-00**
- Student Guide: **MAR-TTRNG-00-00**



### Rigging Procedures:

Rigging Procedures for the Outboard Technician:  
**MAR-RIGGD-20-19**

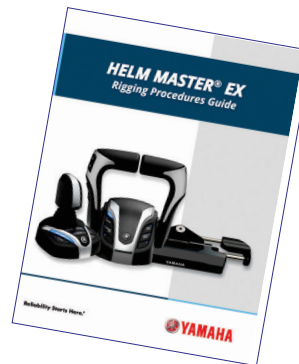

### Helm Master® EX:

Helm Master Rigging Procedures Guide:  
**MAR-HMRPM-EX-00**

### Specification Guides:

- MAR-TSPEC-11-00 (1984-2010)**
- MAR-TSPEC-11-00 (2010~)**



## Outboard Engine Oil

### YAMALUBE® 4M FC-W® Full Synthetic SAE 5W-30

Group IV fully synthetic oil offers our best outboard lubrication and performance, and it's FC-W® rated by the National Marine Manufacturers Association (NMMA®). Contains all of the benefits of mineral oil based Yamalube 4M, with increased lubricity for lower friction levels and potentially improved fuel economy. Specific marine additives help combat rust, corrosion, varnish, and wear; all while providing high levels of bearing protection, resistance to foaming, and lubrication.



### YAMALUBE® 4M FC-W® for Four Stroke Outboards

In order for an oil to be approved by the NMMA® to hold its highest rating for marine engine oils, FC-W® (Four Cycle – Water cooled) it must pass a multitude of tests. Passenger car oils don't pass these tests, which is why it's important to use NMMA®-Certified YAMALUBE 4M FC-W®. Automotive oils do not usually run at 6000 rpm. Yamaha Outboard engines were designed to run at full throttle (5500 to 6000 rpm) all day long. At this speed it is critical that engine oil not foam. Foaming reduces lubricity which can lead to wear and over time this can lead to failure. Yamalube 4M FC-W® has the best blend of anti-foam technology available.



### YAMALUBE® 2M Two Stroke for Outboards

NMMA® TC-W3®-Certified, 2M premium two stroke blend delivers superior lubrication and anti-wear/anti-rust protection for outboard engines operating in demanding marine environments. YAMALUBE 2M is made up of a Semi-synthetic oil with an exclusive additive blend works to guard against ring stick and carbon build up, while special additives minimize wear. This oil is designed for the most grueling conditions two stroke outboards face. Whether it's extended full-throttle operation, engine-punishing "out of the hole" acceleration, or hour after hour of trolling, this oil can take it. *Not recommended for WaveRunner® Personal Watercraft or Sport Boats.*



YAMALUBE® Oil	Quart Bottles (Minimum Order Qty 12)	One Gallon Bottles (Minimum Order Qty 4)	55 Gallon Drum (Minimum Order Qty 1)	330 Gallons
4M FC-W® 05W-30	LUB-05W30-FC-12	LUB-05W30-FC-04		
4M FC-W® 10W-30	LUB-10W30-FC-12	LUB-10W30-FC-04	LUB-10W30-FC-55	LUB-10W30-FC-BK
4M FC-W® 20W-40	LUB-20W40-FC-12	LUB-20W40-FC-04	LUB-20W40-FC-55	
2M Two Stroke Oil	LUB-2STRK-M1-12	LUB-2STRK-M1-04	LUB-2STRK-M1-55	

General Information

Rigging Estimate Guide (Diagrams)

Rigging Components

Electrical Components

Engine Accessories

Propellers

Maintenance Items

Yamalube & Trailer Supplies

Accessories & Apparel

## Outboard Oil Change Kits

Yamaha's oil change kits are designed for the mobile service dealers to provide an easy, all in one oil change package. They're also perfect for the do-it-yourself customer. One stop, one box, and your customer is back on the water. Large, Mid-Range, and Medium Kits have a minimum order quantity of 4. Small oil change kits have a minimum order quantity of 6.



Production Years	Model	Oil Change Capacity	05W-30 Kit	10W-30 Kit	20W-40 Kit	Min. Order Qty.	Kit Contents
'10~	VF250, VF225, VF200	7.1 Qts.	LUB-MRNSH-KT-05			2	VMAX SHO Kit: 8 quarts of oil, oil filter, and drain screw gasket.
'10~	4.2L V6 Offshore Outboards	6.7 Qts.		LUB-MRNXL-KT-10	LUB-MRNXL-KT-20	2	Extra Large Kit: 7 quarts of oil, oil filter, and drain screw gasket.
'11~	4.2L (B & C) F225 ~ F350	6.7 Qts.		LUB-MRNXL-KT-10	LUB-MRNXL-KT-20		
'05-'10	3.3L F250A&B	5.1 Qts.		LUB-MRNLG-KT-10	LUB-MRNLG-KT-20		
'08-'10	3.3L F225 Sport	5.1 Qts.		LUB-MRNLG-KT-10	LUB-MRNLG-KT-20	4	Large Kit: 6 quarts of oil, oil filter, and drain screw gasket
'02-'10	3.3L F225	5.1 Qts.		LUB-MRNLG-KT-10	LUB-MRNLG-KT-20		
'02-'10	3.3L F200	5.1 Qts.		LUB-MRNLG-KT-10	LUB-MRNLG-KT-20		
13~	F200 (In Line)	4.8 Qts.		LUB-MRNMR-KT-10	LUB-MRNMR-KT-20		
14~	F175	4.8 Qts.		LUB-MRNMR-KT-10	LUB-MRNMR-KT-20		
14~	VF175	4.8 Qts.		LUB-MRNMR-KT-10	LUB-MRNMR-KT-20	4	Mid Range Kit: 5 quarts of oil, oil filter, and drain screw gasket.
13~	VF150	4.8 Qts.		LUB-MRNMR-KT-10	LUB-MRNMR-KT-20		
'04~	F150	4.8 Qts.		LUB-MRNMR-KT-10	LUB-MRNMR-KT-20		
'15~	F115 / VF115	3.4 Qts.		LUB-MRNMD-KT-11	LUB-MRNMD-KT-21		
'00-'14	F115A	3.9 Qts.		LUB-MRNMD-KT-11	LUB-MRNMD-KT-21		
'00-'14	F115B	3.9 Qts.		LUB-MRNMD-KT-11	LUB-MRNMD-KT-21		
'99-'02	F100	5.0 Qts.		LUB-MRNMD-KT-11	LUB-MRNMD-KT-21	4	Medium Kit: 4 quarts of oil, oil filter, and drain screw gasket
'03~	F90 / VF90	3.4 Qts.		LUB-MRNMD-KT-11	LUB-MRNMD-KT-21		
'99-'02	F80	5.0 Qts.		LUB-MRNMD-KT-11	LUB-MRNMD-KT-21		
'03~	F75	3.4 Qts.		LUB-MRNMD-KT-11	LUB-MRNMD-KT-21		
'10~	F70	2.3 Qts.		LUB-MRNSM-KT-10	LUB-MRNSM-KT-20		
'03~	T60	2.3 Qts.		LUB-MRNSM-KT-10	LUB-MRNSM-KT-20		
'02~	F60	2.3 Qts.		LUB-MRNSM-KT-10	LUB-MRNSM-KT-20		
'96~	T50	2.3 Qts.		LUB-MRNSM-KT-10	LUB-MRNSM-KT-20		
'95~	F50	2.3 Qts.		LUB-MRNSM-KT-10	LUB-MRNSM-KT-20	6	Small Kit: 3 quarts of oil, oil filter, and drain screw Gasket
'09~	F40A	2.1 Qts.		LUB-MRNSM-KT-10	LUB-MRNSM-KT-20		
'99-'08	F40	2.3 Qts.		LUB-MRNSM-KT-10	LUB-MRNSM-KT-20		
'01-'06	F30	2.3 Qts.		LUB-MRNSM-KT-10	LUB-MRNSM-KT-20		
'13~	F30	2.3 Qts.		LUB-MRNSM-KT-10	LUB-MRNSM-KT-20		

## Pumps and Spouts

### Multi-Purpose Gallon Pump

Universal style gallon-size container pump. Fits standard oil containers with a 1-1/2"neck. A marine lower unit fitting and all-purpose fitting are also included.

**ACC-HNDPU-MP-01**



### Multi-Purpose Quart Pump

Universal style quart-size container pump. Fits standard oil containers with a 1-1/8"neck. A marine lower unit fitting and all-purpose fitting are also included.

**ACC-HNDPU-MP-01**



### 5-Gallon Pail Pump

Use with 5-gallon pails of lube. Comes with special marine lower unit fitting and an all-purpose fitting for filling gearcases.

**LUB-PUMP0-05-GL**



### Manual 55-Gallon Drum Pump

Use with 55-gallon drums of Yamalube.

**ACC-DRMPU-MP-01**



### Oil Extractor Pump

Make changing the oil on your four stroke personal watercraft, snowmobile, ATV, boat, lawn mower, etc. clean and hassle free. Holds up to 6 liters (1.5 gal) in this sturdy portable container. Pump included.

**SBT-OILEX-TR-CT**



General Information

Rigging Estimate Guide (Diagrams)

Rigging Components

Electrical Components

Engine Accessories

Propellers

Maintenance Items

Yamalube & Trailer Supplies

Accessories & Apparel

## Pumps and Spouts



### Ratio Rite®

Provides measures for 16:1- 50:1 mixtures, and cc./oz./pt. for fills.

**ABA-RATIO-RI-TE**



### Disposable Funnel

This paper funnel is great as either a shop tool or as an accessory to an oil change kit.

**ACC-FLDFU-NN-EL**

## Fuel Additives

### What's Good for the Environment Can Be Bad for Your Engine.

Gasolines formulated with ethanol (E10) help to improve air quality, which is why the federal government has mandated their increased use. However, unlike fuels of the past, E-10 fuels are known to absorb moisture, either from the air or from standing water in the bottoms of fuel tanks. They also generate corrosive sulfate salts that can attack metal components in a fuel system, clogging filters and resulting in other performance issues. Because of these known weaknesses, E-10 fuels require special care and treatment, whether your engine is in constant use or in storage. The Yamalube Care Products line includes formulations that help combat the potential harmful side-effects of E-10 fuels, ensuring high performance, lower ownership costs and a long life for your Yamaha. Whether additives with Ethanol or not all gasolines need special care to protect/maintain quality and performance. Today's gasolines are engineered fluids designed to maintain the fresh gasoline potency and power for 2 weeks after manufacturing; after that the gasolines can start the degradation process. Yamalube fuel additives are designed to help maintain the like new performance of the gasoline.

### Why should you use Ring Free Plus?

Gasoline whether fresh, degraded or formulated with ethanol, when burned in the combustion process of a 4-Stroke and/or 2-Stroke engine creates carbon deposits. These carbon deposits create performance robbing formations on fuel injectors, carburetors, intake and exhaust valves, intake ports, combustion chamber, piston rings, ring lands, piston crowns and skirts, which could lead to an engine failure if not properly maintained. Ring Free's exclusive synthetic formulation provides superior carbon deposit control to keep your internal engine components clean from deposit formations, delivering consistent peak performance. The PLUS is a unique blend of metal filmers to help protect fuel system components like silver solder, copper, aluminum and steel from the corrosive effects of ethanol sulfate salts and salt water if present in the fuel system.

- 32 oz. Bottle (Qty. 6\*) ACC-RNGFR-PL-32**
- 12 oz. Bottle (Qty. 12\*) ACC-RNGFR-PL-12**

### Fuel Stabilizer & Conditioner PLUS

Fuel Stabilizer & Conditioner is an exclusive formulation that provides superior Fuel Stabilization performance for Off-Season and In-Season use. Stabilizes ALL gasolines, helps maintain current gasoline potency when added for up to 1 year. Don't wait to stabilize gasoline; it's best to do so at the time of purchase to maintain that fresh gasoline potency. The PLUS is a unique blend of metal filmers to help protect fuel system components like aluminum and steel from the corrosive effects of ethanol sulfate salts and salt water if present in the fuel system.

- 32 oz. Bottle (Qty. 6\*) ACC-FSTAB-PL-32**
- 12 oz. Bottle (Qty. 12\*) ACC-FSTAB-PL-12**



\* Ordered individually with a minimum order quantity

## Grease



### Molybdenum Disulfide

This extreme-pressure grease lubricates high loads at various speeds. Non-corrosive, it's water-resistant, exhibiting low-friction properties that protect against wear and galling in difficult operating conditions.

**4.5 oz. Tube (Qty. 12\*) ACC-MOLDM-GS-05**

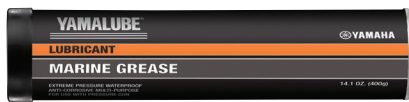

### Marine Grease

Especially formulated to resist wash off, extreme heat, pressure, corrosion, and rust. (NLGI® 2) Lithium soap based. Recommended for use in jet lower units.

**10 oz. Tube (Qty. 12\*) ACC-GREAS-10-CT**

**14 oz. Cartridge (Qty. 10\*) ACC-GREAS-14-CT**



### Multi-Purpose Grease

Specially formulated to resist extreme pressure, water and corrosion. (NLGI® 2).

**ACC-MLTPR-GR-05**

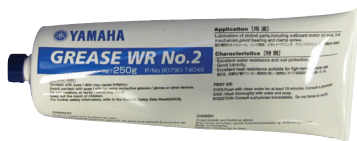

### WR No. 2 Grease

Provides water resistance, rust protection, lubrication and heat resistance. Specially designed for four stroke oil pump seals, drive shaft splines and drive shaft bushing area. For four stroke and two stroke applications.

**90790-74068-00**



\* Ordered individually with a minimum order quantity

## Grease

### Power Trim & Tilt

Premium non-foaming Marine hydraulic fluid formulation that resists heat and pressure found in power trim, tilt and power steering systems for smooth operation. Meets Yamaha factory requirements.

**Quart Bottle (Qty. 12\*) ACC-PWRTR-MF-32**

**10 oz. Tube (Qty. 12\*) ACC-PWRTR-MF-10**



### Marine Gearcase Lube HD

Specially formulated performance Marine GL-5 gearcase lube loaded with anti-rust and anti-corrosion inhibitors required....” For use in 200-250, 4.2L Offshore and XTO. (Not recommended for use in any other Yamaha outboard.)

**Quart Bottle (Qty. 12\*) ACC-GLUBE-HD-QT**

**Gallon Bottles ( Qty 4\*) ACC-GLUBE-HD-GL**

**5 Gallon Pail ACC-GLUBE-HD-05**



### Marine Gearcase Lube

Specially formulated performance Marine GL-4 gearcase lube loaded with anti-rust and anti-corrosion inhibitors for use in all Outboard lower units. (EXCEPT V8 F300-F350, V6 VMAX SHO 200-250, 4.2L Offshore and XTO)

**10 oz. Tube (Qty. 12\*)**

**ACC-GEARL-UB-10**

**Quart Bottle (Qty. 12\*)**

**ACC-GEARL-UB-QT**

**Gallon Bottle (Qty. 4\*)**

**ACC-GEARL-UB-GL**

**5 Gallon Pail**

**ACC-GEARL-UB-05**

**55 Gallon Drum**

**ACC-GEARL-UB-55**



\* Ordered individually with a minimum order quantity

General Information

Rigging Estimate Guide (Diagrams)

Rigging Components

Electrical Components

Engine Accessories

Propellers

Maintenance Items

Yamalube & Trailer Supplies

Accessories & Apparel



## Yamabond® Adhesives



### Yamabond® 4 Marine

This silicone-based liquid gasket fills gaps to prevent leaks. Pressure and oil resistant.

3 oz. Tube **ACC-BOND4-MA-00**



### Yamabond® 5

Coat mechanical joints with this liquid gasket before assembly to prevent leaks.

2.5 oz. Tube **ACC-YAMAB-ON-D5**



### Yamabond® 6B

Has high viscosity and excellent swelling, and works effectively for joint surfaces that have a larger clearance.

3.5 oz. Tube **ACC-YAMAB-ND-6B**



### Yamabond® 7

High-strength, synthetic rubber adhesive formulated for grips, throttle pipes and lever handles, without damaging rubber.

10 gram Tube **ACC-YAMTB-15-01**



### Yamabond® 1386

Used for camshaft caps on four stroke outboard engines.

15 ml Bottle **ACC-YAMBD-13-86**

## Shop Supplies



**Yamaha Internal Engine Cleaner**  
For dealer purchase only. The best product offered by Yamaha for shock treatment carbon removal. Ordered by case, 1 on order equals 6 bottles.

Quart bottle (Qty. 6\*)  
**ACC-CLEAN-D1-00**



**EFI Engine Storage Fogging Oil**  
Equally distributes fogging oil to cylinders in EFI engines with single-throttle bodies, protecting pistons, cylinder walls and valves from moisture, salt water and combustion acids for up to 1 year of storage.

Quart Bottle (Qty. 6\*)  
**ACC-STORR-IT-32**



**Combustion Chamber Cleaner**  
Use to remove carbon and other contaminants from cylinders, pistons, rings and valves. A great inclusion into your seasonal maintenance. Clean engines last longer.

13 oz. Can (Qty. 12\*)  
**ACC-CMBSN-CL-NR**



**Stor-Rite Engine Fogging Oil**  
Lubricates and protects internal engine components. Critical for proper winterization and during extended storage periods.

12 oz. Can (Qty. 12\*)  
**ACC-STORE-RI-TE**



**Brake & Contact Cleaner**  
Use this product to clean off brake dust from critical brake components and quickly clean parts leaving them residue free.

13 oz. Can (Qty. 12\*)  
**ACC-BRKCT-12-00**



**LubezAll**  
This popular lube is back and completely reformulated. Now an aerosol synthetic grease with PTBE, it's a high quality multipurpose lubricant.

11 oz. Can (Qty. 12\*)  
**ACC-LUBZA-LL-00**

\* Ordered individually with a minimum order quantity

## Shop Supplies



### External Engine Cleaner

Powerful engine degreaser and engine cleaner powers off grease, mud and grime. Safe on most rubber, plastic and painted metal surfaces.

15 oz. Can (Qty. 12\*)  
**ACC-ENGCL-NR-00**



### Yamashield™

Designed to create a non-conductive shield on surfaces that are exposed to the elements. This shield will reduce the effects of moisture on metal components and electrical connections. This is a building anti-corrosion agent designed for those hard to reach areas. It can only be removed by the use of a solvent like Mineral spirits if a new application is required.

13 oz. Can (Qty. 12\*)  
**ACC-YAMSH-LD-00**



### Precision Parts Cleaner

Designed to meet all the demands of a fast-drying, powerful cleaner. Formulated to remove oil, grease, and other contaminants. Quickly and easily cleans engine parts, internal and external components, ignitions, electrical components, spark plugs, or any use where a fast-drying cleaner that leaves no residue is needed.

12.5 oz. Can (Qty. 12\*)  
**ACC-PPCPT-CL-NR**



### Silicone Spray Protectant & Lubricant

General-purpose lubricant that helps to protect metals against rust and corrosion. Conditions and protects neoprene, rubber and other surfaces from environmental effects. It's a non-building anti-corrosion agent that can dissipate over time requiring re-application.

11 oz. Can (Qty. 12\*)  
**ACC-SLCNS-PR-AY**

### Marine Spray Paint by Yamalube

A high-quality, factory-matched spray paint for touch-ups or full overcoat application. This durable enamel coating will provide good performance in the rigors of the marine environment.

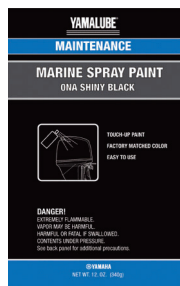

- 8D Dark Bluish Gray 1 ( Qty 6\*) **ACC-MRNPA-IT-8D**
- 4D Dark Bluish Gray Metallic 2 ( Qty 6\*) **ACC-MRNPA-IT-4D**
- NA Shiny Black ( Qty 6\*) **ACC-MRNPA-IT-NA**
- CE White Pearl Base Coat ( Qty 6\*) **ACC-MRNPT-0C-EA**
- CE Pearlescent Clear Coat ( Qty 6\*) **ACC-MRNPT-0C-EB**

\* Ordered individually with a minimum order quantity

## For the Technician

### Nitrile Disposable Mechanics Gloves

These black nitrile gloves are textured to enhance grip action and are up to three to four times the puncture and chemical resistance of latex. Powder free Latex-free 100 gloves per box

Large - **ACC-MECHG-LV-LG**  
X Large - **ACC-MECHG-LV-XL**



### Metric Tool Kit

This handy metric tool kit contains the following: combo wrenches (8, 10, 12 and 14mm), 8" adjustable wrench, locking wrench, 4-way Phillips/standard screwdriver, Allen wrenches (#3, #4, #5 and #6), spark plug wrench, spark plug gap gauge, black electrical tape, WD-40®, tire pressure gauge, zip ties, wire, rag and a handy zippered storage case.

**ABA-METRC-00-00**



### PowerDrive™ Sliding T-Driver with 8-Piece Socket Set by CruzTOOLS®

The PowerDrive™ Sliding T-handle set Includes a 3/8" tip driver, 8, 10, 12, 14, and 17mm sockets, 5 and 6mm hex bits and a #2 Phillips screwdriver bit. A socket clip that attaches to the driver keeps the sockets in order and a rugged vinyl pouch keeps the tools protected.

**ACC-OSS58-40-67**



### Oil Filter Wrench

This stamped steel, chrome plated filter wrench makes removing oil filters a breeze. Simply place the wrench over the end of the filter and turn it using either a 3/8" ratchet or 17mm wrench. Two sizes will cover all of your Yamaha spin-on style filters. For 3FV and 5GH Yamaha Oil Filters.

**MTS-TLSKT-02-09**



General Information

Rigging Estimate Guide (Diagrams)

Rigging Components

Electrical Components

Engine Accessories

Propellers

Maintenance Items

Yamalube & Trailer Supplies

Accessories & Apparel

## Cleaning Chemicals



### Spray Polish

This quick detailer will restore a lustrous shine to paint, chrome, glass and smooth plastics like visors, windshields, and gauges. Gives textured plastics, rubber and vinyl a beautiful satin finish. Anti-static properties repel dust and dirt to keep that shine.

14 oz. Can (Qty. 12\*) **ACC-SPRAY-PL-SH**



### Yamacoat™

A high-quality plastic coating. Helps maintain the color and surface finish of plastic for that "factory" look. Use an even spray on components to be treated. Once spray is applied, wipe off with a clean, dry cloth. Can also be left wet to help inhibit adhesion of mud and dirt to make cleanup easier.

10 oz. Can (Qty. 12\*) **ACC-YAMAC-OA-TC**



### Yamaclean® Pro-Wash Spray

Yamaclean® Pro-Wash Spray is a biodegradable vehicle spray wash that removes grime and soil. Rinses clean and helps keep your boat looking new.

32 oz. Bottle (Qty. 12\*) **ACC-YAMAC-PW-SP**



### Yamaclean® Pro-Wash Spray Concentrate

Special concentrated formula for use in pressure washer soap tanks. A biodegradable vehicle wash that removes grime and soil. Rinses clean and helps keep your vehicle looking new. Safe for use on most surfaces when used as directed.

1 Gallon Bottle (Qty. 4\*) **ACC-YAMAC-PW-GL**

\* Ordered individually with a minimum order quantity

## Tire Repair and Supplies

### TirePro™ Dial Tire Gauge by CruzTOOLS®

The TirePro™ gauge has a 12" flexible hose that makes even hard-to-get-to valves less of a task. Readings are held until released, and a built-in valve lets you bleed air to the desired pressure. The dial is protected by a rubber boot and readings are in both psi and kPa.

**ACC-0SS58-40-69**



### Tire Mount Lube

Specially formulated lubricant that allows you to change tires on the rim quickly with less chance of damage. Use on any rim-mounted tire to provide a lubricated surface that eases tire installation while helping to protect the tire bead from damage. Preventing damage to the tire bead improves its sealing ability.

16 oz. Can (Qty. 12\*) **ACC-TIREM-TL-UB**



## Locks and Security

### McGard® Wheel Locks

McGard®'s easy to use, one-piece wheel lock functions like a regular lug nut, but requires a special key tool for installation and removal. Its design allows for an unlimited number of different computer generated lock and key patterns. This unique wheel lock system is continually being refined and improved upon. McGard® Locks are made right here in the United States to meet or exceed O.E.M. standards for safety and durability

Single Axle Trailer (2 locking nuts): **MAR-TRLK7-40-42**

Dual Axle Trailer (4 locking nuts): **MAR-TRLK7-40-41**



\* Ordered individually with a minimum order quantity

General Information

Rigging Estimate Guide (Diagrams)

Rigging Components

Electrical Components

Engine Accessories

Propellers

Maintenance Items

**Yamalube & Trailer Supplies**

Accessories & Apparel

## Trailer Repair Supplies



### Brake Fluid

This high-quality hydraulic brake fluid meets DOT 4 specifications and is the only brake fluid currently recommended for use in Yamaha products.

8 oz. Bottle

(Qty. 12\*) **ACC-BRAKE-FL-UD**



### 3300 Lb. Hand Winch Strap

Marine winch strap with forged snap closure hook. Sewn loop for bolt placement in winching system. Strong 2"-wide black polyester webbing.

2" x 25' **SBT-BOWST-RP-11**

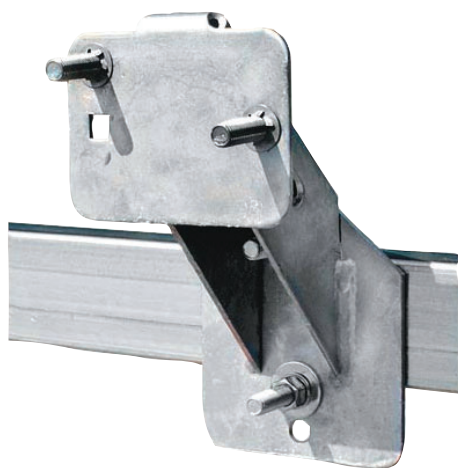

### Spare Tire Carrier

Zinc plated. Clamps to the trailer frame with no drilling. Uses same size lug nuts as stock trailer lug nuts. All necessary mounting hardware included. Fits all standard boat trailers.

**SBT-SPARE-TC-08**

## Tie Downs and Straps

### Yamaha Deluxe 2-Foot Transom Ties

Quality transom tie downs with an attractive price. Similar to what is supplied from the factory on Yamaha boats, these transom ties are made of 2" wide, weather-resistant polypropylene webbing with heavy-gauge, zinc-plated hardware and rubber coated "J" hooks to protect the transom of your boat. Oversized handle makes for easy locking and unlocking. Sewn-on hook-and-loop fasteners help secure the loose end of the strapping. Excellent for securing your Boat to the trailer at an affordable price. Sold in pairs.

**SBT-TRNSM-TD-08**



### Yamaha Cam Buckle Tie Downs

1" x 6' tie downs with 1" cam lock buckle. Straps are rated for 400 lb. working and 1200 lb. break strength. (Sold in pairs.)

Black **ACC-0SS58-40-27**

Blue **ACC-0SS58-40-28**



### Yamaha Ratcheting Tie Downs

1" x 6' tie downs with 1" rubber handle ratchet. Straps are rated for 400 lb. working and 1200 lb. break strength. (Sold in pairs.)

Black **ACC-0SS58-40-29**

Blue **ACC-0SS58-40-30**



### Heavy-Duty Re-Tractable Ratcheting Tie Downs

1"-wide tie down is rated at 1500 lb. with a WLL (Work Load Limit) of 500 lb. and the 2"-wide model is rated at 4000 lb. with a WLL of 1333 lb. (Sold in pairs.)

1" Wide **ACC-0SS58-40-17**



General Information

Rigging Estimate Guide (Diagrams)

Rigging Components

Electrical Components

Engine Accessories

Propellers

Maintenance Items

Yamalube & Trailer Supplies

Accessories & Apparel



## YDIS (Yamaha Diagnostic System)



Part Number	Description	Qty.
90890-06981-00	YDIS 2 Hardware Kit III	1
<b>Individual Replacement Kit Components</b>		
6DE-85335-01-99	Adapter, Interface	1
6DE-82582-00-99	Adapter Cap	1
See Note 1	USB Cable	1
90890-06978-00	YDIS K and CAN Harness	1
90890-06979-00	YDIS CAN Conversion Harness	1
6DE-82582-00-99	AD Harness	1
6DE-8533A-60-99	Power Supply Harness	1
6DE-8533A-40-99	Trigger Switch Harness	1
6DE-8533A-50-99	Trigger Switch Extension Harness	1
<b>Optional Equipment</b>		
90890-06906-00	K-Line Extension Harness 16' (5m)	1
90890-06900-00	Command Link/Command Link Plus DEC Checker Harness Kit	1
90890-06886-00	Signal Tester Kit	1
90890-06979-00	CAN Line Conversion Harness (Required for BPS Scan)	1

Note1: One A/B type USB cable, to connect the adapter module to a USB port on a laptop computer, is supplied with the hardware kit. Replacement A/B (printer) type USB cable, in various lengths, can be purchased from local sources.

### YDIS Smart

The YDIS Smart adapter uses Bluetooth® technology to establish wireless communication between compatible Yamaha outboards and your smartphone, via the K-Line on the engine. The new mobile application provides quick access to essential menus necessary for accurate troubleshooting. The YDIS Smart application is available on the App Store for Apple® iOS and Google Play Store™ for Android® operating systems. A previously purchased YDIS 2.2 PC version installation key is required to install the app.



**LIT-YDISM-AR-T0**





Description	Page
Anchors	9-1
Fenders	9-3
Ropes and Dock Lines	9-6
Tubes and Inflatables	9-9
Inflatable Pumps and Valves	9-11
Battery Chargers and Battery Switches	9-12
Magma® Grills and Accessories	9-13
Coolers	9-19
Boat Starter Kits	9-20
General Boating Accessories and Upgrades	9-21
Personal Floatation Devices	9-25
Hats and Visors	9-27
Apparel & Gifts	9-28

## Anchors



### Boat Sand Stake Kit

If you would like to anchor your Yamaha boat on a sandy beach, simply screw the stake into the sand, remove the handle, and attach the 25 feet of heavy-duty rope. A storage bag is also provided.

**MAR-SANDS-TK-KT**



### Yamaha Heavy-Duty Boat Anchor Kit

This anchor kit is specifically designed with the larger boats in mind. This kit includes an 11 lb., vinyl-coated anchor and chain which helps prevent corrosion as well as scratched hulls. A 100-foot rope with a snap hook is included along with a convenient storage bag.

**MAR-ANCHR-KT-00**



### Complete Folding Grapnel Anchor Kit

This complete anchor system is in a class by itself. The 3-1/3 pound 4-fluke folding anchor will hold in mud, sand, gravel, and rock. It's designed for temporary mooring of small boats, sailboats, personal watercraft, inflatable boats, canoes, and float tubes. The anchor is coated to protect finishes. The durable nylon storage case is padded for added protection and to dampen noise while the anchor is stowed. Fits under most boat seats. The 25 ft. long marine-grade rope, with an in-line buoy, is spliced to the anchor and a heavy-duty stainless steel snap hook.

5.5lb - **VDF-A7452-63-17**

3.5lb - **VDF-A2000-00-17**



### Mushroom Anchor

This 8 lb. mushroom anchor comes with 15 feet of nylon rope, a high visibility plastic float, and a plastic clip. This setup is perfect for anchoring in shallow water.

**MAR-ANCHR-MR-08**

## Anchors

### 14-LB. Yamaha Boat Anchor Kit

This S920 Danforth® Yamaha kit features a 1/2" x 200' rope and 8' stainless steel chain and shackles.

**SBT-YS920-00-19**



### Boat Anchor Kit

This Yamaha Boat Anchor designed specifically to fit the anchor storage of your boat. Kit includes a galvanized 10-Danforth® style anchor a 6-foot chain shackled 100 feet of standard nylon rope that's sinkable for convenient setting.

**SBT-ANCHR-KT-08**

Black Colored Chain **SBT-ANCHR-BK-12**



### Tri-Fluke Anchor

The tri-fluke design of this river anchor allows the flukes to penetrate the river bottom in soft and moderate conditions, to engage rocks and structure in rivers and current. The river anchor is a great all-purpose anchor for lighter craft, or a great second anchor. Weight: 20 lb.

(Not Shown) Black **SBT-520BK-20-12**

(Not Shown) Red **SBT-520RD-20-12**

(Shown) Blue **SBT-520BL-20-12**



### Richter™ Self Releasing Anchor

Performance in rocks mud, weeds, and sand is superior to traditional anchors and requires less anchor line. Weight: 18 lb.

**SBT-618B2-18-12**



## Fenders



### Yamaha 24-Inch Boat Contour Fender

These contour fenders stay put and stow conveniently under boat seats. They hinge to wrap around the gunwale and hull, following the contours of the boat. Constructed of a durable marine grade tri-laminate cover, with closed cell foam inside. There's a tough polycarbonate grommet at each end for hanging from cleats. (Sold Individually. 24" long x 6" wide x 2-1/2" thick)

Blue **MAR-HHFND-ER-BL**

Black **MAR-HHFND-ER-BK**

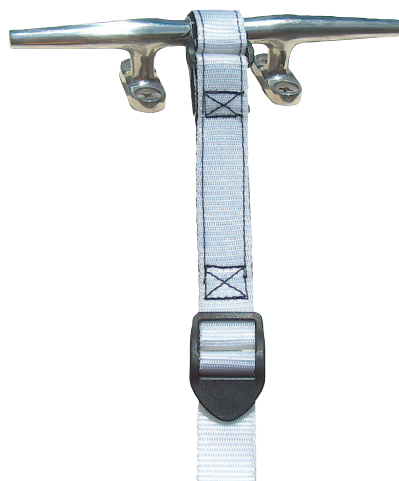

### No-Slip™ Fender Straps

No more tying and untying knots! Attach boat fenders to rails and cleats quickly and securely with these fender straps. The No-Slip™ pads sewn to the underside of the straps minimize sliding along rails. Easily adjust the length in seconds from 6 inches to 40 inches to fit most boats and docking situations.

(Set of 2) **MAR-FNDRS-TR-AP**



### Suction Cup Fender Straps

Great for Boats and Personal Watercraft. Attach your boat fenders exactly where you need the protection. Giant 3-1/4" suction cups attach to gelcoat or windshields quickly and easily. Perfect for most boats and personal watercraft where cleats never seem to be where you need them. Durable 1" wide straps adjust up to 24" long. Fenders not included.

(Set of 2) **SBT-SF1C0-00-10**

## Fenders

### Yamaha Fenders

These high-quality fenders help to protect the boat when secured to the dock or another boat. These come equipped with four feet of rope. (Sold individually.)

16" White **MAR-FENDR-WH-16**

16" Blue **MAR-FENDR-00-16**

20" White **MAR-FENDR-WH-20**

20" Blue **MAR-FENDR-00-20**

23" White **MAR-FENDR-WH-23**



### Yamaha XL Boat Fenders

Designed specifically for Yamaha Boats these fenders help protect your boat while secured to other boats or docks. 24"x10", includes dock lines.

Black **SBT-FENDR-BK-23**

White **SBT-FENDR-WH-23**



### Dock Bumper

Crafted with UV-resistant, tear-proof vinyl, and a polyester tri-laminate construction, it withstands the elements with resilience. The high-density closed-cell foam guarantees ultimate protection, absorbing impact and preventing damage. With corrosion-proof grommets, this bumper is not only sturdy but also long-lasting, offering peace of mind for your aquatic haven.

24" **VDF-HHB24-W0-24**

36" **VDF-HHB36-W0-24**



### Dock Corner Bumper

Crafted with UV-resistant, tear-proof vinyl, and a polyester tri-laminate construction, it withstands the elements with resilience. The high-density closed-cell foam guarantees ultimate protection, absorbing impact and preventing damage.

12" **VDF-HHBC2-W0-24**



General Information

Rigging Estimate Guide (Diagrams)

Rigging Components

Electrical Components

Engine Accessories

Propellers

Maintenance Items

Yamaha & Trailer Supplies

Accessories & Apparel



## Fenders



### Marina Bumper By Hull Huger®

These heavy-duty commercial grade bumpers are great for commercial marinas and personal docks. They're manufactured from UV and tear resistant vinyl/polyester tri-laminate and are filled with high-density closed-cell foam. The Stainless Steel grommets are spaced along the full length of each bumper for secure mounting to docks. Measures 8" wide x 6" deep.

36" **VDF-HHA36-20-24**

48" **VDF-HHA48-20-24**

60" **VDF-HHA60-67-17**



### Roll Up Fenders by Hull Huger®

The patented design allows you to fold up the fender compactly, making it easy to stow or use as a seat cushion. Six blocks for durable closed cell foam are sealed inside. For use with higher profile boats, including cruisers, performance boats, pontoons, deck boats, sailing yachts and households.

HH-L & LW 9' long x 26" tall, 6-24" x 6" x 2-1/2" foam bumpers, folds to 26" x 18" x 6"  
Blue - **VDF-HHL60-72-17**

HH-S & SW 7 1/2' long x 15" tall, 6- 12" x 6" x 2"  
foam bumpers, folds to 15" x 15" x 4"  
Blue - **VDF-HHS60-58-17**



### Hull Huger® Contour Fender

Traditional round fenders can roll up, leaving your boat unprotected, and are bulky to stow. Boats with step-down gunwales are especially vulnerable to dock damage. The contour fender stays out, stows conveniently under boat seats and wraps around the gunwale and hull, following the contours of the boat.

White **VDF-0010H-H1-17**

Blue **VDF-HH1C0-00-17**

Black **VDF-HH1CB-00-17**



### Hull Huger® XL Contour Fenders

Traditional round fenders tend to roll up from contact with docks, leaving your boat unprotected. They're also bulky to stow. Boats with step down gunwales are especially vulnerable to damage from docks. Hull Huger® Contour Fenders stay put and stow conveniently under boat seats. They hinge to wrap around the gunwale and hull, following the contours of the boat. All Hull Huger®s are constructed with a tough marine grade rip proof trilaminate cover, with closed cell foam inside. Durable polycarbonate grommets at each end allow you to hang them from cleats. (Sold Individually.) (30" long x 6" wide x 4" thick)

Blue **VDF-HH30C-00-17**

Black **VDF-HH30C-B0-17**

## Ropes and Dock Lines

### Dock Lines

These dock lines are made of multi-filament, solid braid polypropylene. Floats if accidentally dropped in water and resists salt water, oil, gas, UV rays, and mildew. (Sold individually.)



	12 Foot 3/8 in. Diameter	15 Foot 3/8 in. Diameter	20 Foot 1/2 in. Diameter
<b>Yamaha Branded</b>			
White	MWV-DLDE3-12-WH	MWV-DLDE3-15-WH	SBT-DLDE1-20-WH
Silver	MWV-DLDE3-12-SL	MWV-DLDE3-15-SL	SBT-DLDE1-20-SL
Black	MWV-DLDE3-12-BK	MWV-DLDE3-15-BK	SBT-DLDE1-20-BK
Red	MWV-DLDE3-12-RD	MWV-DLDE3-15-RD	SBT-DLDE1-20-RD
Blue	MWV-DLDE3-12-BL	MWV-DLDE3-15-BL	SBT-DLDE1-20-BL
<b>Non-Branded</b>			
White		MWV-DLDG3-15-WH	SBT-DLDG1-20-WH
Silver		MWV-DLDG3-15-SL	SBT-DLDG1-20-SL
Black		MWV-DLDG3-15-BK	SBT-DLDG1-20-BK
Red		MWV-DLDG3-15-RD	SBT-DLDG1-20-RD
Blue		MWV-DLDG3-15-BL	SBT-DLDG1-20-BL

### Greenfield Stretch N' Slide® Multi-Loop Versatile Dock Line

Without question, Stretch N' Slide® is the world's most versatile and easy to use dock line. Innovative multi-loop bungee allows a perfect fit for any span to 7'. Simply place the end loop over a cleat, then stretch and tighten down the slider, and, finally, select the appropriate loop to place over the second cleat. Stretch N' Slide® makes docking quick and easy for any craft from PWC to large boats. Stretch N' Slide® is also the ultimate solution for rafting boats together for a party chain. Shock-absorbing bungee allows an entire chain of boats to move and flex together with ease. Temporary docking only.

**SBT-SNSLN-00-12**



### Airhead® Bungee Dock Lines

Airhead® Bungee Dock Lines absorb shock to boats, cleats, docks, pylons and other hardware. The bungee cord is hidden inside the rope and acts as a built-in snubber. Two foam floats help protect the boat from chafing. There's a sliding adjustment at both ends for quick docking. Recommended for docking boats up to 4000 pounds. Tensile strength is 2150 pounds. Black/Blue/Red color scheme. (Sold Individually.)

4 ft., stretches to 5 1/2 ft. **VDF-AHDL4-00-17**

5 ft., stretches to 7 ft. **VDF-AHDL5-82-17**

6 ft., stretches to 9 ft. **VDF-AHDL6-00-17**



## Ropes and Dock Line



### 1~2 Rider Tube Tow Rope

This tube tow rope has two sections, giving you the option to be either 50 or 60 feet behind the boat depending on wake and water conditions. The pre-stretched, UV-resistant 7/16" diameter 16-strand rope exceeds the 2375 lb. break strength required by the WSIA for 2-rider tubes. A rope keeper is included for convenient storage.

Blue **MAR-TUBER-OP-06**

Red **SBT-TUBER-OP-10**



### 3~4 Rider Tube Tow Rope

This 4-rider tube tow rope has 2 sections, giving you the option to tow either 50 or 60 feet behind the boat depending on wake and water conditions. The pre-stretched UV-resistant 5/8" diameter 16-strand rope exceeds the 4150 pound break strength required by the WSIA for 4-rider tubes. A 6" foam float is provided for extra buoyancy. A rope keeper is included for convenient storage.

**SBT-TUBER-P0-07**



### Airhead® Kwik-Connect™ Tow Rope Connector

Conveniently attach and detach tube tow ropes to towables with Airhead's® Kwik-Connect™. There's no need to thread 60 feet of rope through the tow strap each time you connect or disconnect a tow rope. The high-impact Kwik-Connect™ has a 1-inch diameter hole to accept up to 6000 lb. break strength tube ropes. Recommended for 1- to 4-rider towables that are not equipped with Kwik-Connect™.

**VDF-AHKC1-00-17**

## Tow Line, Floats and Tow Harness

### Emergency Tow Line

Tow line consists of a 15-foot long tow line with a nylon quick connect at each end that allows fast, easy hook-ups. For slow-speed emergency towing only.

**MWV-TOWLI-NE-15**



### Yamaha Rope Float/ Yamaha Rope Clip

The Yamaha Rope Float and Rope Clip can be used to create a custom rope to suit your needs. Each Sold Separately.

**MAR-ROPEF-LO-AT**

**MAR-YROPE-CL-IP**



### Ski Rope Floats

Developed to help keep ski ropes away from the propeller on your boat or to help prevent them from being ingested by the pump. Run your ski rope through the middle of the nylon-covered, closed-cell foam tube before attaching to the tow eye. Yamaha logo silk-screened on one side.

48" Black **MAR-RPFLT-BK-48**

48" Blue **MAR-RPFLT-BL-48**

24" Black **MAR-RPFLT-BK-24**

24" Blue **MAR-RPFLT-BL-24**



### Centering Tow Harness

This 3000-pound-tensile-strength tow harness is perfect for pulling skiers and wakeboarders, as well as 1- or 2-rider towables. A stainless steel pulley glides along the length of the rope to provide the optimum pull at all times. Simply clip it onto your boat with the 5000-pound-tensile-strength hooks provided, and attach your ski or tube rope to the heavy duty Kwik-Connect™. The 6" float keeps the Kwik-Connect™ floating. It's 12' long to fit pontoon and larger boats.

**VDF-AHTH3-00-17**



## Tubes and Inflatables



### Yamaha Single Rider Tube Kit

This kit features a 54" diameter deck tube with four deluxe handles and neoprene knuckle guards and is equipped with a Boston valve for convenient inflating and deflating. Package includes a portable 12-volt pump to inflate quickly and effectively, a color matched 16 strand tube tow rope and reinforced tow harness, drain vents, and boarding straps.

Gray **SBT-GYSRK-GY-22**

Yellow **SBT-GYSRK-YW-21**



### Yamaha 3- Rider Deck Tube

This high performance three-rider towable has fins on the top to help riders stay on the tube and out of the water. Features six deluxe nylon-wrapped handles with neoprene knuckle guards to provide a sure and comfortable grip and a 30 gauge virgin PVC bladder fully covered with an 840D double stitched nylon cover. The heavy-duty Kwik-Connect™ provides easy and secure hook-ups while the Boston valve provides convenient inflation and deflation. Measures 78" x 75" (deflated); Weight limit: 340 pounds.

**SBT-GY3TB-GR-21**



### Yamaha 2- Rider Deck Tube

This deck tube is a wild ride for up to two thrill seekers. Features topside stabilizer fins, four deluxe nylon-wrapped handles with neoprene knuckle guards to provide a sure and comfortable grip, tough heavy-gauge virgin PVC bladder and fully covered with a durable double-stitched nylon cover. Equipped with a heavy-duty Kwik-Connect™ for easy and secure tow-rope hook-ups and speed safety valve provides convenient inflation and deflation. measures: 64" x 60" (deflated): Weight limit: 340 pounds.

**SBT-YHGF2-00-17**

## Tubes and Inflatables



### Yamaha Single Sport Tube

You are sure to love the eye-catching graphics on this 54" round towable. The four neoprene knuckle guards and deluxe nylon covered handles provide a sure and comfortable grip. Self-draining floor vent. Features a reinforced internal tow harness, and Boston valve for quick inflation/deflation.

**SBT-YHBL1-RD-18**



### Yamaha 2-Rider Winged Deck Tube

Get way up on edge with this U-shaped winged towable when riders shift their weight. Thicker at the front to prevent submarining and thin at the back to make it easier to climb on from the water, Deluxe handles with neoprene knuckle guards to provide a sure and comfortable grip, Two oversized neoprene pads are strategically located to protect knees and elbows, Durable 30 gauge reinforced welded PVC bladder completely wrapped in double-stitched 840 denier nylon, Heavy-duty Kwik-Connect™ provides easy and secure tow-rope hook-ups, Boston valve makes it easy and fast to deflate and inflate, Measures 73" x 61" deflated, 340 lb. weight limit.

**SBT-YHMX2-00-17**



### Yamaha Floating Island

1-6 person linkable, floating island with a patented speed safety valve for easy inflating & deflating. Also Features heavy-duty radio frequency welded seams and a dual color reversible design. 6' x 10' (deflated size).

**SBT-AIRIL-00-23**



### Inflatable Paddle Board

This 11' 6" Yamaha Branded Inflatable paddleboard kit features a 6" premium drop stitch construction. Kit Includes board, pump, paddle, and storage case.

**MAR-INPDL-BD-23**

## Inflatable Pumps and Valves



### 12-Volt Air Pump

This high-volume (290 liters/minute) 12-volt portable air pump inflates and deflates towables, boats, pools, mattresses, and beach toys quickly and effectively. Many pumps on the market don't put out this kind of air pressure and volume (9.6 cu. f t./min. 0.8 psi). The universal valve fittings fit all popular valves. For added convenience, the cigarette lighter/12-volt power port plug is equipped with a 10' long power cord.

**MAR-12VPU-MP-06**



### Airhead® 120 Volt Hi-Pressure Air Pump

A Pressure Release Valve is included to limit pressure to 1.4 psi for preventing over-inflating towables, pool toys and other vinyl and nylon covered inflatable items. Four universal valve fittings fit all popular valves and lock onto the hose. For added convenience, there's a carry handle and a 10' long power cord. Draws 6.1 amps /730 watts. Volume is 460 liters/minute.

**VDF-AHP12-0H-17**



### NOCO® GENIUS5™ Battery Charger

The NOCO® GENIUS5™ is a 6-volt and 12-volt battery charger, battery maintainer and battery desulfator rated at 5 amps for a variety of lead-acid and lithium-ion batteries including AGM, automotive, marine and deep-cycle batteries.

**DBY-ACC51-70-17**



### NOCO® GEN5X2 ONBOARD CHARGER

The NOCO® GEN5X2 is a two-bank onboard battery charger rated at 10-amps (5-amps per bank) for 12-volt batteries, including marine, boat, starter, and deep-cycle batteries. Independently charge and control each battery bank with selectable charging modes- including 12V, 12V AGM, 12V Lithium, and 12V Repair Mode - for all types of lead-acid and lithium-ion batteries..

**SBT-2BATC-HR-23**

## Battery Chargers and Battery Switches

### Emergency On-Demand Jump Starter By VOXX™

An Emergency on-demand jump starter that gives you peace of mind all the time. The VPS is wired directly to the main battery. As the Boat is on, the VPS pulls a trickle charge to its Lithium Iron Phosphate battery, ensuring it's always fully charged.

**MAR-JUMPB-OX-22**



### Marine Dual Battery Kit

This kit is a must-have when adding additional electronics to your boat (stereo upgrades, bars, etc.). This kit comes complete with a BEP Marine Battery 701S™ Battery Switch, a BEP Marine Voltage Sensitive Relay (VSR), and a GIL Marine® Composite Battery Box plus all necessary wiring and hardware. This kit will allow you to keep one battery isolated at all times for reserve purposes. The VSR will allow the engines to charge battery #1 until it is topped off at 13.7 VDC, then automatically switch over to battery #2 to charge it. Turn the knob on the battery switch to select using battery #1 by itself, battery #2 by itself, or both batteries together in parallel. You can also switch off battery current altogether. Professional installation recommended. Marine batteries not included. Fits any single battery boat with room for another group 24 battery.

**SBT-DUALB-AT-08**





## Magma® Grills and Accessories



### Catalina II Classic Gas Grill

The new Catalina II Gas Grill is versatile, portable, and perfect for feeding a large crew. New features include: a completely redesigned combustion system that keeps the grill lit even in heavy winds, a hermetically sealed thermometer and a dependable electronic ignition system, powered by a single “AAA” battery (included). Constructed entirely of 18-8 mirror-polished stainless steel. The primary and secondary grilling surfaces give you the option of searing, slow cooking, or warming. Equipped with fold-away tabletop legs for go-anywhere use. The swiveling control valve/regulator, designed to use 1lb. disposable propane fuel canisters, allows for quick, safe fuel canister exchanges or easily adapt the grill to existing on-board low pressure propane (LPG) or natural gas (CNG) fuel systems. Serves 6-8 people.

**SBT-A1012-18-20**



### 8x17 Stainless Grill Tray

This 8” x 17” grill tray is made entirely of 18-9 marine grade stainless steel and comes with a convenient, insulated, removable handle. The removable handle simplifies grilling, serving, storage, and allows the tray to be used as an oven pizza tray or cooking sheet. Oven safe and dishwasher friendly. Serves 4-6 people.

**SBT-A1029-70-00**



### Catalina Grill Cover

This grill cover is designed specifically to fit any Magma® rectangular grill with a 12” X 18” grilling surface. Constructed from a breathable solution dyed acrylic fabric that is water and fade resistant. Cover features a convenient draw string and cam lock assembly keep it secured while underway or in windy conditions.

**SBT-A1012-9B-K0**



### Magma® Padded Grill & Accessory Carrying / Storage Case

Designed to store all of your grilling gear in one space-saving location, this bag is outfitted with a large storage compartment for a grill and pockets for storing a serving shelf, griddle or a fish/veggie tray. It also includes an additional side pocket for storing up to (2) 1-pound propane canisters and (2) control valve/regulators. Additional features include thick padding for maximum protection and heavy-duty carrying handles and a padded strap.

**SBT-GRILL-BG-11**

## Magma® Grills and Accessories

### Magma® Newport™ Gourmet Gas Grill

Just the right size for grilling up to eight large hamburgers, the Newport™ Gourmet Gas Grill is a finely crafted appliance. Fold-away legs make this the go-anywhere grill to enhance all of your outdoor activities. Its performance and safety features will certainly exceed expectations as it grills quickly and evenly and disassembles easily for cleaning. Uses inexpensive, disposable one-pound propane cylinders or adapts to onboard LPG (propane). Mount not included and sold separately. NOTE: Mount fits 2013 and newer boat models only.

Grill **SBT-NEWPO-RT-11**  
Mount **SBT-NPGRL-MT-14**



### Newport Storage Case

Storage case designed specifically to fit any Magma® rectangular grill with a 9" X 12" grilling surface and is able to store all of your grilling gear in one space saving location. Includes a removable internal section in the main compartment for carrying up to (2) 1lb. propane canisters. Designed to fit a grill with 9x18 grilling surface.

**SBT-C1098-8B-00**



### Newport Grill Cover

This grill cover is designed specifically to fit any Magma® rectangular grill with a 9" X 18" grilling surface. Constructed from a breathable solution dyed acrylic fabric that is water and fade resistant. Cover features a convenient draw string and cam lock assembly keep it secured while underway or in windy conditions.

**SBT-A1099-BK-00**



### Rectangular Griddle

These removable two-sided griddles are made from cast aluminum and coated with a non-stick finish. The non-corrosive, cast aluminum prevents heat distortion to maintain a perfect fit with the grill top. Featuring an elevated griddle surround design to keep food and grease splatter contained.

8" x 17" diameter. Fits 9" x 18" or larger rectangular grills  
**SBT-A1019-51-00**

11" x 17" diameter. Fits 12" x 18" or larger rectangular grills  
**SBT-A1019-71-00**



## Magma® Grills and Accessories



### Magma® Trailmate™ Gas Grill

Enhance your outdoor activities with this compact, go-anywhere TrailMate™ Gas Grill. This is perfect grill for any small crew or gathering and features fold-away legs and 108 sq. in. grilling area. The TrailMate™ is made of mirror-polished, marine-grade 18-9 stainless steel for dependability and is wind-tested for even heat distribution. Its fuel-efficient design uses standard, disposable one-pound propane canisters. The TrailMate™ uses single-mount mounting hardware only. Mount sold separately. Measures: 9" x 12". Note: Mount fits 2013 and newer boat models only.

Grill **SBT-TRAIL-GL-12**  
Mount **SBT-TMGRL-MT-14**



### Trailmate™ Storage Case

Conveniently store and transport your grill and accessories in Magma's® luggage quality Padded Storage and Carrying Case. Case is outfitted with a large storage compartment, to fit Magma® and most rectangular grills with a 9"x12" grilling surface, and a separate internal pocket for storing a serving shelf and/or grilling utensils. Includes a removable internal section in the main compartment for carrying up to (3) 1 lb. propane canisters.

**SBT-C1098-8A-00**

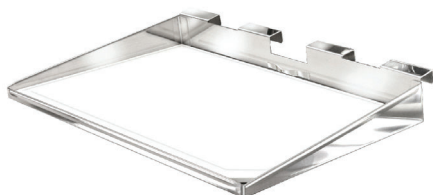

### Serving Shelf

This 18-8 mirror polished marine grade Stainless Steel serving shelf includes a removable cutting board. The shelf installs instantly making clean up and storage a breeze. Conveniently stores inside of your grill when not in use.

18" Wide **SBT-A1090-20-00**  
fits 9" x 18" or Larger Rectangular Grills.

12" Wide **SBT-A1099-10-00**  
fits 9" X 12" or Larger Rectangular Grills.



### Trailmate™ Grill Cover

This grill cover is designed specifically to fit any Magma® rectangular grill with a 9" X 12" grilling surface.

Constructed from a breathable solution dyed acrylic fabric that is water and fade resistant. Cover features a convenient draw string and cam lock assembly keep it secured while underway or in windy conditions.

**SBT-A1089-BK-00**

## Magma® Grills and Accessories

### Party Size Marine Kettle® Gas Grill

This grill was designed for economy without sacrificing functionality and quickly disassembles without tools for easy clean-up. Compatible with the Marine Kettle® Pow'r GripFish Rod Holder Mount.

**SBT-A1021-50-00**



### Marine Kettle® Storage Case

The Marine Kettle® Storage Case is outfitted with a large storage compartment and a separate internal pocket for storing a serving shelf and or grilling utensils. Includes removable internal section in the main compartment for carrying up to (4) 1 lb. propane canisters.

**SBT-1099-10-00**



### Marine Kettle® Grill Cover

This grill cover is designed specifically to fit any original size Magma® Marine Kettle® grill. Constructed from a breathable solution dyed acrylic fabric that is water and fade resistant. Cover features a convenient draw string and cam lock assembly keep it secured while underway or in windy conditions.

**SBT-A1049-2B-K0**



### Party Size Marine Kettle® Grill Serving Tray

Fits Party Size Marine Kettle® Gas Grill

This 18-8 mirror polished marine grade Stainless Steel serving shelf includes a removable cutting board. The shelf installs instantly making clean up and storage a breeze. Conveniently stores inside of your grill when not in use.

**SBT-A1027-90-00**



## Magma® Grills and Accessories



### Round Griddle

Fits Party Size Marine Kettle® Gas Grill

The removable 2-sided Griddle is made from cast aluminum and coated with a non-stick finish. The non-corrosive, cast aluminum prevents heat distortion to maintain a perfect fit with the grill top. Featuring an elevated griddle surround design to keep food and grease splatter contained. 14.75" diameter.

**SBT-A1019-80-00**



### Double Locking Stowable Pedestal Mount

Magma®'s 28" locking pedestal mount for rectangular grills and single mount file tables has a double locking mechanism that insures a secure fit for your boat or home application. The Pedestal post locks into the surface mounting base and grill mounting bracket with (2) single pushbuttons; allowing the entire assembly to be instantly installed or removed.

Requires the Magma® LevelLock® Adjustable All-Angle Accessory for Magma® Pedestal Mount to work with the following grills: Trailmate, Newport & Catalina II.

**SBT-T1018-50-00**



### Magma® Single LevelLock® Flush Deck Socket Mount

This mirror-polished 18-8 stainless steel and hard-anodized aluminum mount features Magma®'s LevelLock® all-angle, adjustable locking mount, a pushbutton locking pin and a flange gasket with integral flip-up water seal cap. Fasteners required for installation (not included).

**SBT-FLDEK-MT-12**



### Magma® 5-Piece Professional Grill Tool Set

The Magma® 5-Piece Professional Grill Tool Set features four telescoping professional quality grilling tools made of mirror polished, marine-grade 18-9 stainless steel and a carrying case with a rubberized, soft-touch handle for an easy, secure grip. Tools adjust to three different operating lengths to meet any griller's needs and collapse for compact storage in the carrying case (included).

**SBT-UTENS-5P-12**

## Magma® Grills and Accessories

### Bait/Filet Mate™ Table With LevelLock® Mount By Magma®

This 20" x 12-3/4" table and mount features an engraved Magma® logo and handy ruler, increasing visibility when measuring the day's catch. Grooved sides and a slotted table back provide onboard drainage during cleaning or prep. The LevelLock® all-angle fishing rod holder mount with quick-release cam action also folds flat for storage, and the 1-1/2" (38mm) 304 stainless steel tube has eight rotational positions and fits most cross-pin type rod holders. Made of 100% UV-stabilized compression molded high-density color core polyethylene and FDA approved for food preparation and service. Also features plier storage and two redesigned knife holsters. Will not crack, peel, mildew, or absorb bacteria or fish odors.

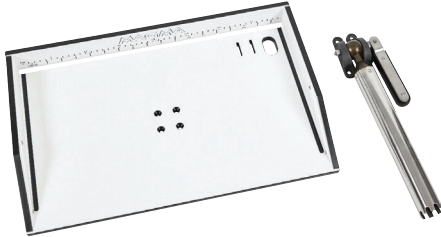

**SBT-T1031-B0-17**

### LevelLock® Adjustable All-Angle Accessory For Magma® Pedestal Mount

This mounting bracket allows you to conveniently level and support your Newport, Trail Mate or Catalina Classic II grill when connected to Magma's Double Locking Stowable Pedestal Mount.



**®SBT-T1019-20-00**

### Pow'r Grip/LevelLock® Rod Holder Mount

This rugged stainless steel mount adjusts and locks in place at both ends ensuring that your Magma® rectangular grill or filet table will stay securely in place. Fits most cylindrical type rod holders and its unique quick disconnect system allows instant installation or storage after use without tools.



**SBT-T1037-50-00**

### Marine Kettle® Pow'r Gripfish Rod Holder Mount

The Marine Kettle® rod holder grill mount fits most cylindrical type rod holders and allows grills to mount in any direction from the rod holder. Unique quick disconnect system allows instant installation or storage after use without tools. Rod holder not included.



**SBT-A1017-50-00**

## Coolers



### Engel® Coolers

Engel® 25/35/45 High-Performance Coolers are roto-molded for toughness and durability. They are filled with 2 inches of insulation in the lid and on the sides and the bottom, helping to retain cold and ice for up to 8 days. The all-silicone gaskets create a near airtight seal that is durable and will never lose its shape.

25 **SBT-ENG25-WH-20**

35 **SBT-ENG35-WH-20**

45 **SBT-ENG45-WH-20**



### Yamaha Inflatable Floating Cooler

The Yamaha Inflatable Floating Cooler is an insulated leak-proof nylon cooler that is removable from the inflatable base by simply lifting on the adjustable shoulder strap. It keeps 12 cans or bottles and ice cold for hours. The 6 drink holders in the floating base are marked with numbers to help you and your friends keep track of your drinks. A molded plastic rope connector is sewn to the durable nylon cover for tying up to your WaveRunner®, boat, dock, etc.

**MAR-FLTCL-ER-06**



### Yamaha Soft Side Cooler

This cooler is ideal for keeping your beverages and snacks cool. Features include zippered storage compartment easily holds 24 cans plus ice, waterproof liner and high-density insulation keeps ice longer and contents cooler. Unique adjustable securing panel helps hold contents in place while in motion. Includes a shoulder strap and a Yamaha logo bottle opener. Approximate dimensions: 18" L x 7" W x 12" D.

**B8K-F847U-V0-00**

## Boat Starter Kits



### Yamaha Boat Starter Kit

Here's a convenient way to get started with supplies you need for your Yamaha Boat. Kit provides four U.S. Coast Guard Approved/UL Listed PFDs that are adjustable to fit most adults (sizes small to large), plus an approved Type IV throwable flotation device, and a generously sized nylon case to store them in when you aren't boating. Kit also includes a 3.5-oz. air horn and an easy-to-pack first aid kit. For your docking needs, the kit has two black Yamaha 24" Boat Contour Fenders, two No-Slip Fender Straps (shown attached to cleats, not included), and four white 15-foot dock lines. Accented with the Yamaha logo.

Yamaha **SBT-BOATK-IT-08**



### Yamaha Boating Starter Kit

Refreshed and Re-branded for 2021, the Yamaha Boating Starter Kit has all of your on the water essentials in one bag. Boating Starter Kit includes: (1) Yamaha Branded Wet/Dry storage bag, (4) Yamaha Branded PFD's, (1) Yamaha Throwable Cushion, (4) Yamaha Double Braided Dock Lines, (1) First Aid Kit and (1) Air Horn with Top, 3.5 oz. can.

**SBT-SBKIT-RD-21**



## General Boating Accessories and Upgrades

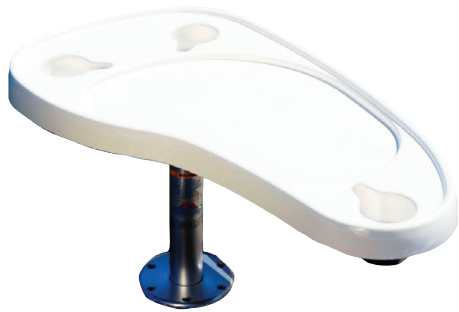

### Yamaha Kidney Shape Table

Want to upgrade your stock table to a larger size? This big table offers more functionality, with a kidney shape so it is easy to maneuver around it, yet it still fits in the stock storage location on your Yamaha Boat. It also has three cup holders instead of two as on the stock table. Designed as a direct replacement, this table is made of the same acrylic capped ABS material as the stock table, and uses the same hardware. Requires transfer of the pedestal base from the stock table.

**SBT-KDNYT-BL-08**



### Yamaha Emblem

Show your Yamaha pride on your vehicle with these new high quality 3D metal logo decals. 16" x 3.2". (Sold as a set of 2.)

**SBT-DECAL-3D-08**



### Tuning Fork Emblem

Factory Yamaha emblem.

**F0C-U411H-00-00**

## General Boating Accessories

### Series 800 Registration Kits

3" Block style, solid body with bevel effect, contrasting outline, Kits include four sets of A-Z and 0-9, Choose from four color combinations. Meets USCG requirements.

- Blue/Black **SBT-BLBLK-80-13**
- White/Black **SBT-LTBLK-80-13**
- Red/Black **SBT-REBLK-80-13**
- (Shown) Silver/Black **SBT-SIBLK-80-13**



### Premium Registration Kits

3" Block style, solid body contrasting outline. All kits include four sets of A-Z and 0-9. Choose from color combinations or solid options below. Meets USCG requirements.

- Black/Beige **SBT-BLBKE-70-11**
- Blue/Black (shown) **SBT-BLBLK-70-11**
- Chrome/Black **SBT-CHBLK-70-11**
- Silver/Black **SBT-SIBLK-70-11**
- Red/Black **SBT-REBLK-70-11**
- Solid Black **SBT-BLK70-00-11**



### Multi Color Registration Kits

Contains four fuel-resistant stickers of each letter (A~Z) and number (0~9). Meets U.S. Coast Guard regulations.

- Brown/Black **MAR-BRBKG -20-89**
- White/Black **MAR-WHBKG -20-19**
- Silver/Black **MAR-SIBKG-20-16**
- Blue/Black (shown) **MAR-BLBKG-20-65**
- Yellow/Black **MAR-YEBKG-20-13**
- Red/Black **MAR-REBKG-20-28**
- Chrome/Black **MAR-CHBKG-20-43**



### Solid Color Registration Kits

Contains four fuel-resistant stickers of each letter (A~Z) and number (0~9). Meets U.S. Coast Guard regulations.

- Black **MAR-BLK35-00-14**
- Blue **MAR-BLU35-00-15**
- White **MAR-WHI35-00-21**
- Red (shown) **MAR-RED35-00-00**



General Information

Rigging Estimate Guide (Diagrams)

Rigging Components

Electrical Components

Engine Accessories

Propellers

Maintenance Items

Yamaha & Trailer Supplies

Accessories & Apparel

## General Boating Accessories and Upgrades



### Life Line™ Boat Safety Kit

This boat safety kit contains 4 items. Recommended for all boats. Contents: 15 meter (50 ft.) buoyant heaving line, bailer (watertight container), sound signaling device (pea-less whistle), and watertight flashlight.

**VDF-LL200-00-17**



### Telescoping Paddles

This lightweight paddle adjusts easily to variable lengths with a simple twist. A section of the aluminum shaft disappears inside the blade to allow for ultra-compact storage under boat seats. The corrosion resistant aluminum shaft, hassle free locking device and high-impact molded blade and boat hook handle provide years of service.

(Shown) Yamaha Branded Blue Paddle (20"~45") **MAR-DLXPA-DL-42**

Bright Orange Paddle (20"~45") **VDF-P1PDL-00-17**

Bright Orange Paddle (25.5"~72") **VDF-P3PDL-00-17**

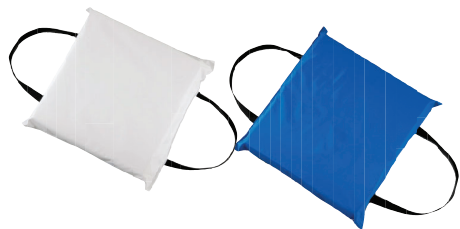

### Yamaha Type IV Throwable Flotation Device

U.S. Coast Guard regulations require your Yamaha Boat to have a Type IV throwable flotation device aboard. This USCG-approved cushion is constructed of high-buoyancy polyethylene foam with durable nylon fabric.

Non-Branded Blue **VDF-LIFEP-BL-17**

Non-Branded White **VDF-LIFEP-WH-17**

## General Boating Accessories and Upgrades

### CIPA® Comp Universal Boat Mirror

A truly universal 7" x 14" mirror. Features a ball and socket tension adjustment knob that will keep the mirror where you position it. Bracket will mount to rectangular or round-top windshield frames from 3/8" to 1-1/4". Meets Alabama's 78-square-inch law.

**SBT-20000-00-10**



### CIPA® Suction Cup Mirror

No holes to drill, no tools required, no scratching! Attaches to any clean, smooth, non-porous surface. Dash, console or windshield mount. Fully adjustable 4" x 8" mirror.

**SBT-11050-00-10**



### CIPA® Ellipse Mirror

4" x 11" multi-lens mirror features one stationary and two adjustable lenses. Also has a ball and socket tension adjustment knob that will keep the mirror where you position it. CIPA's windshield frame bracket will mount to rectangular or round-top windshield frames from 3/8" to 1-1/4".

**SBT-20020-00-10**



General Information

Rigging Estimate Guide (Diagrams)

Rigging Components

Electrical Components

Engine Accessories

Propellers

Maintenance Items

Yamaha & Trailer Supplies

Accessories & Apparel

## Personal Flotation Devices



### Yamaha Value Neoprene 2-Buckle PFD

U.S. Coast Guard approved PFD includes a two-buckle front-zip closure for additional support and security. Soft, lightweight and durable PE foam flotation closure. Mesh drain panels reduce water retention.

Colors: Navy, Gray and Black. Sizes: XS-3X.

**MAR-22VVN-NV-(XS-3X)**

**MAR-22VVN-GY-(XS-3X)**

**MAR-22VVN-BK-(XS-3X)**



### Yamaha Men's Neoprene 2-Buckle PFD

U.S. Coast Guard approved. High-quality neoprene construction. Fully segmented foam panels. Durable front-zip entry. Two adjustable straps with side-release buckles for additional support and security.

Colors: Blue, Black and Red. Sizes: SM-2X.

**MAR-22VNE-BK-(SM-2X)**

**MAR-22VNE-RD-(SM-2X)**

**MAR-22VNE-BL-(SM-2X)**



### Yamaha Women's Neoprene 2-Buckle PFD

U.S. Coast Guard approved. High-quality neoprene construction. Fully segmented foam panels. Durable front-zip entry. Two adjustable straps with side-release buckles for additional support and security.

Colors: Teal, Pink, and Black. Sizes: SM-2X.

**MAW-22VNE-TL-(SM-2X)**

**MAW-22VNE-PK-(SM-2X)**

**MAW-22VNE-BK-(SM-2X)**



### Neoprene PFD with Side Handles

U.S. Coast Guard approved. Heavy-duty, coated nylon with a convenient side entry. Features front, side and back foam for a comfortable fit. Adjustable straps and three side release buckles for added protection. Dual sizing design. Colors: Grey and Navy.

Sizes: SD-S/M, LX-L/XL, 3L-2X/3X.

**MAR-23HAN-GY-(SD-3L)**

**MAR-23HAN-BL-(SD-3L)**

**MAR-23HAN-GN-(SD-3L)**

## Personal Flotation Devices



### Men's Nylon 3-Buckle PFD

U.S. Coast Guard approved, nylon, 3-buckle PFD.  
Colors: Black, Blue or Red. Sizes: XS-4X.

**MAR-23V3B-BK-(XS-4X)**

**MAR-23V3B-BL-(XS-4X)**

**MAR-23V3B-RD-(XS-4X)**



### Woman's Nylon 3-Buckle PFD

U.S. Coast Guard approved, nylon, 3-buckle PFD.  
Colors: Blue, Pink or Orange. Sizes: XS-3X.

**MAW-23V3B-BL-(XS-3X)**

**MAW-23V3B-PK-(XS-3X)**

**MAW-23V3B-OR-(XS-3X)**



### Men's Neoprene/Nylon Combo PFD

U.S. Coast Guard approved, neoprene/nylon combo PFD.  
Colors: Grey or Blue. Sizes: SM-2X.

**MAR-23NNC-GY-(SM-2X)**

**MAR-23NNC-BL-(SM-2X)**



### Woman's Neoprene/Nylon Combo PFD

U.S. Coast Guard approved, neoprene/nylon combo PFD.  
Colors: Yellow or Plum. Sizes: SM-2X.

**MAW-23NNC-YL-(SM-2X)**

**MAW-23NNC-PL-(SM-2X)**

## Hats and Visors



**Yamaha Pro Fishing Hat**  
*Blue and White - CRP-14HPR-WH-NS*



**Yamaha Visor**  
*CRP-14HVI-BL-NS*



**Retro Sunset Flatbill Cap**  
*WTC-21HSN-BK-NS*



**Compass Dial Flatbill Cap**  
*WTC-21HCS-BK-NS*



**Sunset Wave Cap**  
*WTC-22HSV-RD-NS*



**Shark Fin Cap**  
*WTC-21HLS-GY-NS*



**Diamond Sun Cap**  
*WTC-22HDM-BK-NS*

## Apparel & Gifts



**Yamaha Pro Fishing Jersey**  
*CRP-14JPF-WH-(SM~3X)*



**Yamaha Pro Fishing Short Sleeve Tee**  
*CRP-14SPF-BL-(SM~3X)*



**Yamaha Pro Fishing VMAX Tee**  
*CRP-18TVM-BK-(SM~3X)*



**Yamaha Pro Fishing Saltwater Tee**  
*CRP-18TDF-BK-(SM~3X)*

General Information

Rigging Estimate Guide (Diagrams)

Rigging Components

Electrical Components

Engine Accessories

Propellers

Maintenance Items

Yamaha & Trailer Supplies

**Accessories & Apparel**



## Apparel & Gifts



**Yamaha Pro Fishing Off-Shore Short Sleeve Tee**  
*CRP-18TDF-BL-(SM-3X)*



**Yamaha Pro Fishing Fresh Water Short Sleeve Tee**  
*CRP-18TPF-BL- (SM-3X)*



**Run The Water Yamaha Boats Tee**  
*WTC-20TYB-BL- (SM-3X)*



**Run The Water Yamaha Boats spf 60 Long Sleeve Tee**  
*WTC-20LYB-BL- (SM-3X)*

## Apparel & Gifts



**Yamaha Pro Fishing  
Saltwater Gray L/S  
CRP-18LML-GY-(SM~3X)**

**Yamaha Pro Fishing  
Freshwater Gray L/S  
CRP-18LBS-GY-(SM~3X)**



**Yamaha Pro Fishing  
Saltwater Blue L/S  
CRP-18LDF-BL-(SM~3X)**

**Yamaha Pro Fishing  
Freshwater Blue L/S  
CRP-18LPF-BL-(SM~3X)**

General  
Information

Rigging Estimate  
Guide (Diagrams)

Rigging  
Components

Electrical  
Components

Engine  
Accessories

Propellers

Maintenance  
Items

Yamaha &  
Trailer Supplies

**Accessories  
& Apparel**

## Apparel & Gifts



**Yamaha Marine Key Chain**  
*MAR-KEYCH-AI-NB*



**Yamaha Marine Floating Key Chain**  
*MAR-KEYCH-AI-NC (Blue)*  
*MAR-KEYCH-AI-ND (Red)*



Versatile and durable, your gear will stay dry inside this round bottom dry bag. Features durable, waterproof, 19 oz. vinyl construction with reinforced welded seams and Yamaha logo graphic.

**Yamaha Roll Top Bag**  
*MWV-DRYBG-00-16*

















Reliability. It may start with a Yamaha, but it's sustained with proper care and maintenance. Yamaha offers everything customers need to keep their outboard and boat ready to run.

Regular maintenance is critical for the continued proper operation of any engine. Add in the fact that an outboard operates under some of the harshest environmental conditions imaginable, and maintenance becomes even more critical. High load, high-RPM operation, extreme temperatures, high moisture and periods of non-use all take a toll on an outboard. For these reasons, regular maintenance is vital for care free days on the water.

Remember, **MAINTENANCE MATTERS<sup>®</sup>**



The innovative minds at Yamaha Outboards and Siren Marine have joined forces to bring you the most robust marine IoT experience ever created. The new Siren Connected Boat<sup>®</sup> app merges everything you love about Yamaha's maintenance tracking functions with Siren's unique option to monitor and control boat systems remotely. It truly puts your boat in the palm of your hand—no matter where you are.

REMEMBER to always observe all applicable boating laws. Never drink and drive. Dress properly with a USCG-approved personal flotation device and protective gear.

This document contains many of Yamaha's valuable trademarks. It may also contain trademarks belonging to other companies. Any references to other companies or their products are for identification purposes only, and are not intended to be an endorsement.

© 2024 Yamaha Motor Corporation, U.S.A. All rights reserved.



LIT-MRPDC-AT-24